

**twd**<sup>®</sup>



# PODNOŽE NÁBYTKOVÉ NOHY

## OBSAH

Voga design .....	4
Voga - systém desk bar .....	9
Voga - systém hide .....	18
Voga - systém edge .....	22
Voga - systém back .....	25
Voga - systém kota .....	27
Voga - systém solo .....	28
Voga - systém eltipla (elektrické podnože) .....	29
Voga - špeciálne podnože .....	30
Voga - stolové nohy .....	31
Voga - sklopné stolové nohy .....	34
Voga - centrálné podnože .....	36
Voga - príslušenstvo .....	42
Soklové nohy .....	46
Voga - nábytkové nohy .....	50
Klzáky a kolieska .....	53





## VOGA DESIGN

## BUĎTE EXKLUZÍVNI VYTVORTE SI VLASTNÝ PRODUKT

### VÝHODY VOGA DESIGN

- **Flexibilita dizajnu produktu:**
  - výška
  - dĺžka
  - šírka 600-1600 mm \*
  - farba \*\*
  - typ a veľkosť kovových profilov
- **Systémové riešenia:**
  - dvojité pracovné priestory
  - extrémne dĺžky a hmotnosti \*\*\*
  - možnosti rohových stolov, lineárne predĺženie ...
- **Silné, bezpečné a stabilné rámy**
- **Extrémne vysoká presnosť detailov**
- **Rýchla a ľahká montáž**

\* Niektoré modely, pri ktorých nie je dôležitá šírka, nie sú zahrnuté.

\*\* Dostupné sú takmer všetky farby v stupnici RAL.

\*\*\* Systém BIG; max. záťaž je 400 kg / m<sup>2</sup>, max. váha



## VOGA DESIGN



**AIR** systém



**BIG** systém

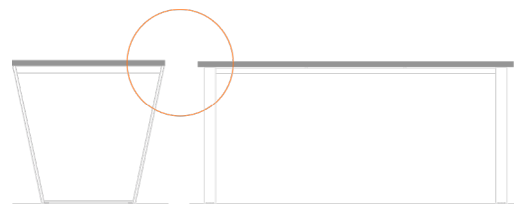

**HIDE** systém

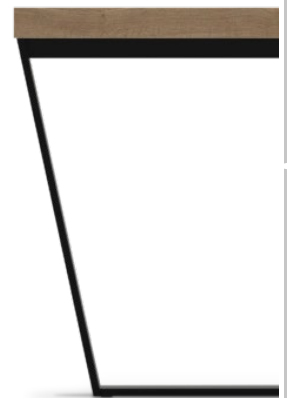

### CENOVÁ KALKULÁCIA

Približnú cenovú kalkuláciu Vám vyhotovíme na základe vyplnenia formulára na našej twd stránke:



<https://www.twd.sk/voga-design/>

**MIX** systém



## VOGA DESIGN

**AIR**

Systém určený pre plávajúce stolové dosky s 10 mm odstupom podnože, ktorý je vhodný pre tenké a ľahké stolové dosky



AA



ASTRA



ASA



ASLIM



AOX



AQ



AU

**BIG**

Optimálny systém pre extrémnu záťaž, určený pre stolové dosky z kameňa, betónu, skla a masívneho dreva s maximálnou dĺžkou 4,5 m



B-A



B-P



B-U



B-X



B-TRA

**HIDE**

Z vonkajšej strany nie sú viditeľné žiadne skrutky



HA



HIFE 70/30



HIFE 50



HU

## VOGA DESIGN



### MIX

Systém tvorený samostatne a nezávisle stojacími podnožami, vhodný ako pre jedáľenské stoly tak aj pre veľké konferenčné stoly



CAGE



CROSS HIFE



DRON



HI DRON



SPIKE



TRIPOD



XXL



XXS

## JEDNODUCHÁ A SILNÁ KONŠTRUKCIA

Uhlové riešenia

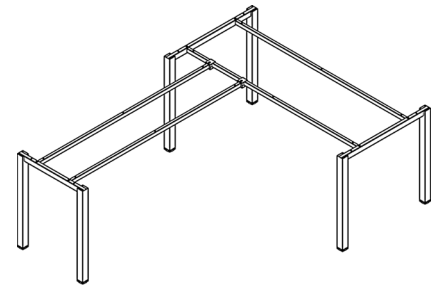

Veľký rozsah rozmerov

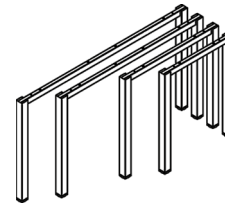

Jednoduché rozšírenia

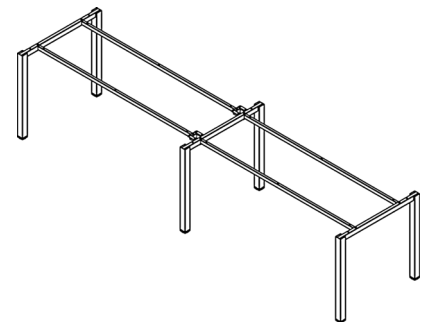

Riešenia dvojitého stola

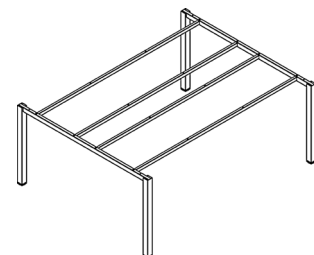

## VOGA SYSTÉMY

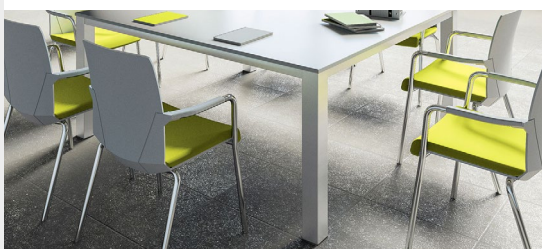
**SYSTÉM DESK BAR****SYSTÉM HIDE****SYSTÉM EDGE****SYSTÉM BACK****SYSTÉM KOTA****SYSTÉM SOLO****SYSTÉM ELTIPLA**



## VOGA - SYSTÉM DESK BAR



### TEMPO T 400

Obj. číslo:	Farba:	Šírka podnože:	Výška:
80-30002	RAL 9006G	425 mm	715 mm

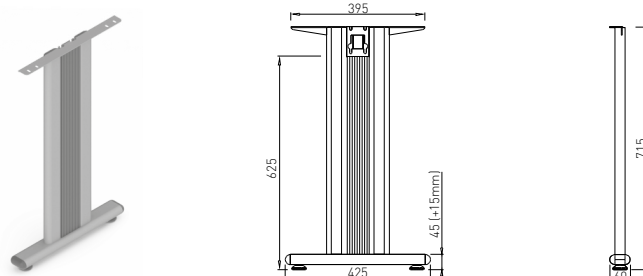

### TEMPO T 600

Obj. číslo:	Farba:	Šírka podnože:	Výška:
80-30000	RAL 9006G	625 mm	715 mm

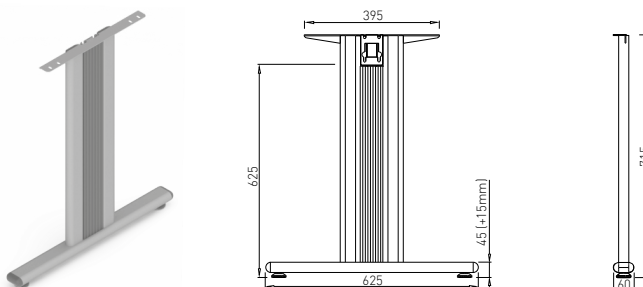

### TEMPO T 800

Obj. číslo:	Farba:	Šírka podnože:	Výška:
80-30006	RAL 9006G	810 mm	715 mm

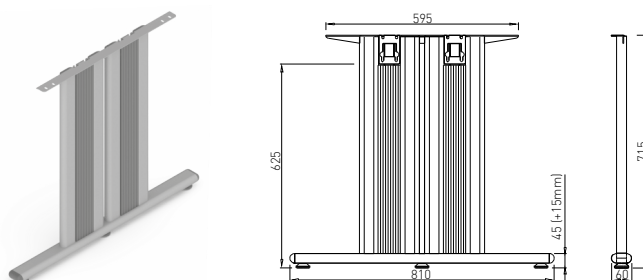

### COMO C 700

Obj. číslo:	Farba:	Šírka podnože:	Výška:
80-30145	RAL 9006G	695 mm	715 mm

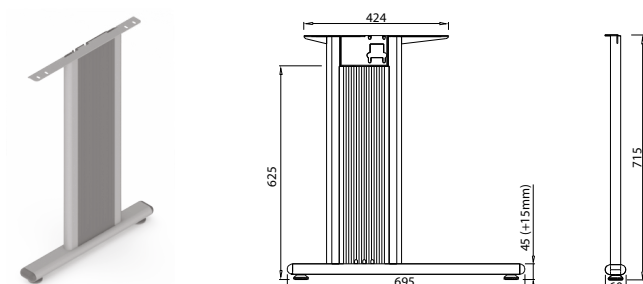

## VOGA - SYSTÉM DESK BAR

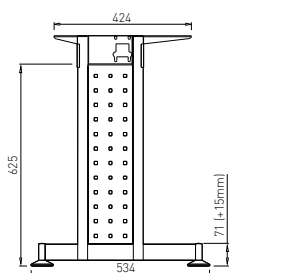
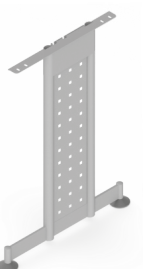
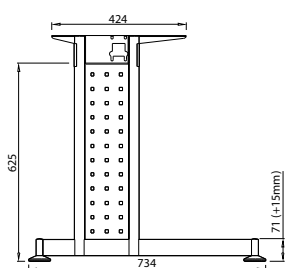
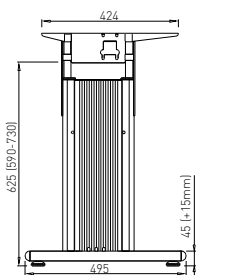
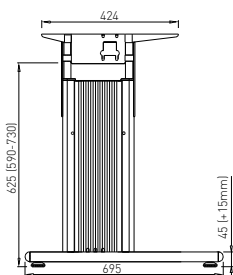
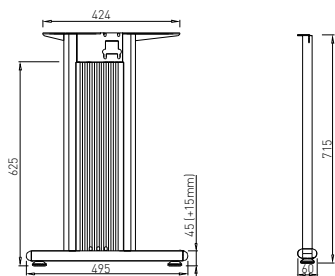

## COMO C 500

Obj. číslo:	Farba:	Šírka podnože:	Výška:
80-30143	RAL 9006G	495 mm	715 mm

## COMO C 700 HV

Obj. číslo:	Farba:	Šírka podnože:	Výška:
80-30182	RAL 9006G	695 mm	715 - 820 mm

## COMO C 500 HV

Obj. číslo:	Farba:	Šírka podnože:	Výška:
80-30057	RAL 9006G	495 mm	715 - 820 mm

## MARK C 700

Obj. číslo:	Farba:	Šírka podnože:	Výška:
80-30210	RAL 9006G	734 mm	715 mm

## MARK C 500

Obj. číslo:	Farba:	Šírka podnože:	Výška:
80-30184	RAL 9006G	534 mm	715 mm

## VOGA - SYSTÉM DESK BAR



### MARK C 700 HV

Obj. číslo:	Farba:	Šírka podnože:	Výška:
80-30185	RAL 9006G	734 mm	715 - 820 mm

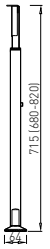
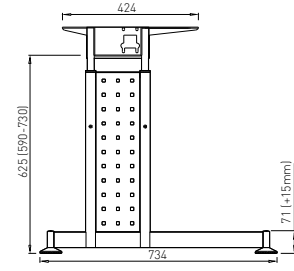
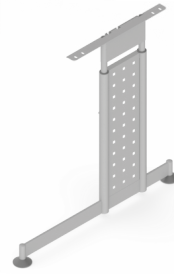

### MARK C 500 HV

Obj. číslo:	Farba:	Šírka podnože:	Výška:
80-30186	RAL 9006G	534 mm	715 - 820 mm

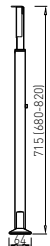
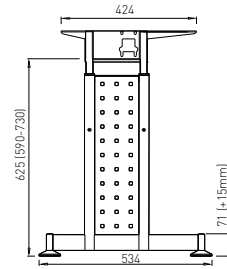
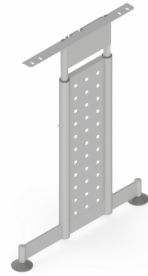

### TILL T 600

Obj. číslo:	Farba:	Šírka podnože:	Výška:
80-30121	RAL 9006G	625 mm	715 mm

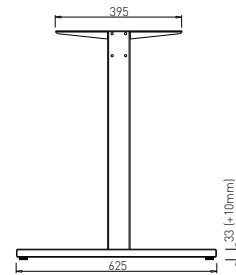

### TILL T 600 HV

Obj. číslo:	Farba:	Šírka podnože:	Výška:
80-31273	RAL 9006G	625 mm	715 - 820 mm

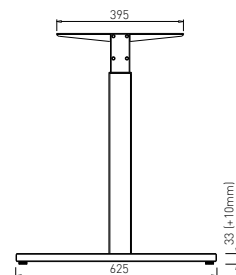

### TILL T 400 HV

Obj. číslo:	Farba:	Šírka podnože:	Výška:
80-31274	RAL 9006G	425 mm	715 - 820 mm

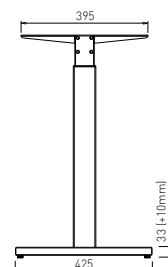
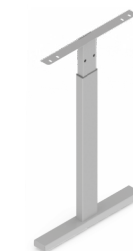

## VOGA - SYSTÉM DESK BAR

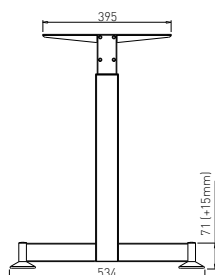
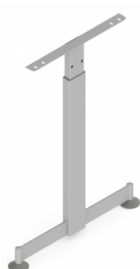
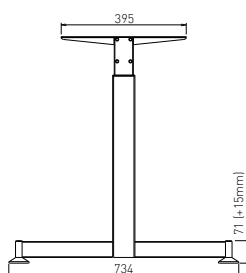
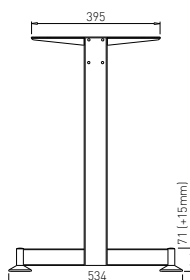
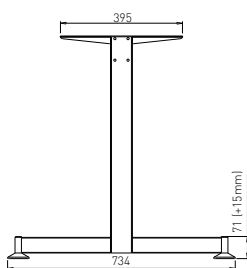
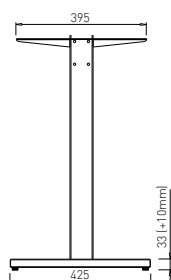
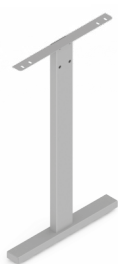
**TILL T 400**

Obj. číslo:	Farba:	Šírka podnože:	Výška:
80-31272	RAL 9006G	425 mm	715 mm

**TEND T 600**

Obj. číslo:	Farba:	Šírka podnože:	Výška:
80-30744	RAL 9006G	734 mm	715 mm

**TEND T 400**

Obj. číslo:	Farba:	Šírka podnože:	Výška:
80-30745	RAL 9006G	534 mm	715 mm

**TEND T 600 HV**

Obj. číslo:	Farba:	Šírka podnože:	Výška:
80-30985	RAL 9006G	734 mm	715 - 820 mm

**TEND T 400 HV**

Obj. číslo:	Farba:	Šírka podnože:	Výška:
80-30986	RAL 9006G	534 mm	715 - 820 mm

## VOGA - SYSTÉM DESK BAR



### WORK T 600

Obj. číslo:	Farba:	Šírka podnože:	Výška:
80-30199	RAL 9006G	625 mm	715 mm

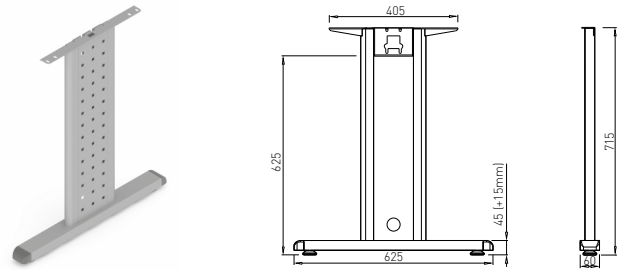

### WORK T 400

Obj. číslo:	Farba:	Šírka podnože:	Výška:
80-30198	RAL 9006G	425 mm	715 mm

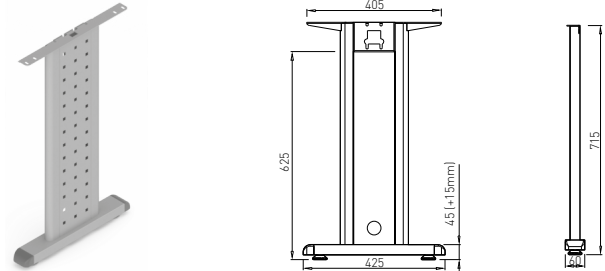

### WORK T 600 HV

Obj. číslo:	Farba:	Šírka podnože:	Výška:
80-30201	RAL 9006G	625 mm	715 - 820 mm

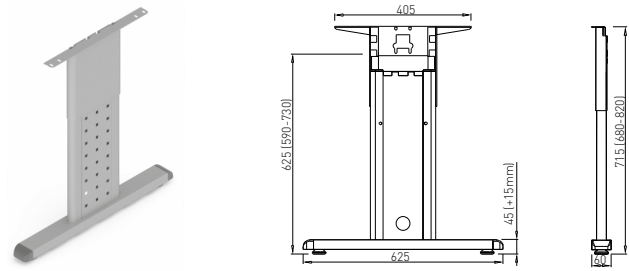

### WORK T 400 HV

Obj. číslo:	Farba:	Šírka podnože:	Výška:
80-30200	RAL 9006G	425 mm	715 - 820 mm

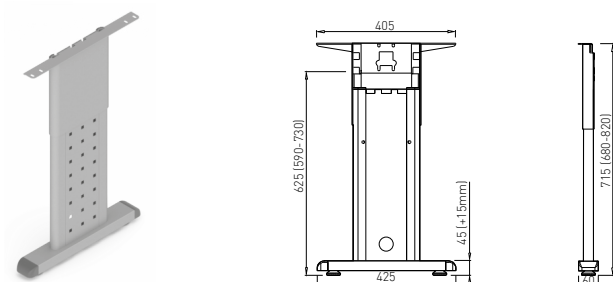

### MOST

Obj. číslo:	Farba:	Šírka:	Výška:
80-31270	RAL 9006G	780 mm	715 mm

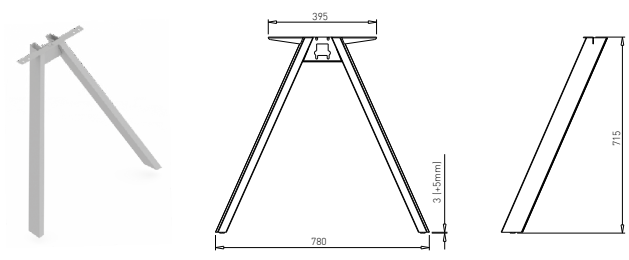

## VOGA - SYSTÉM DESK BAR - PRÍSLUŠENSTVO

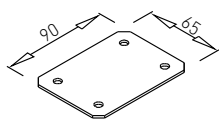
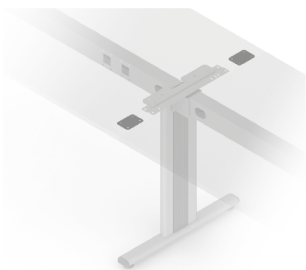
**SPOJKA STOLOVEJ DOSKY 90 x 65 mm**

Obj. číslo:	Farba:	Dĺžka:	Šírka:
<b>80-30027</b>	RAL 9006G	90 mm	65 mm

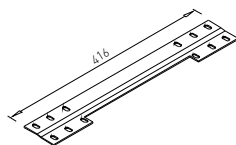
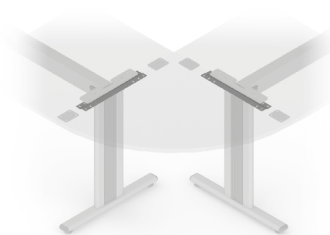
**SPOJKA STOLOVEJ DOSKY „Z“**

Obj. číslo:	Farba:	Dĺžka:
<b>80-30024</b>	RAL 9006G	416 mm

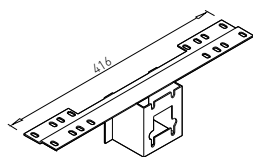
**SPOJKA NA PREDĽŽENIE STOLA**

Obj. číslo:	Farba:	Dĺžka:
<b>80-30394</b>	RAL 9006G	416 mm

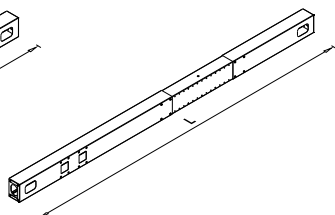
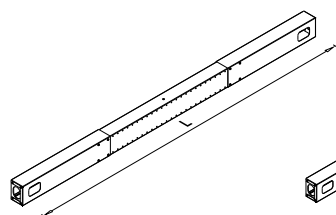
**TELESKOPICKÁ SPOJKA STOLOVÝCH NÔH**

Obj. číslo:	Typ:	Farba:	Dĺžka:
<b>80-31141</b>	TELESKOPICKÁ SPOJKA 1000 - 1600	RAL 9006G	903 - 1503 mm
<b>80-31140</b>	TELESKOPICKÁ SPOJKA 1400 - 2000	RAL 9006G	1303 - 1903 mm

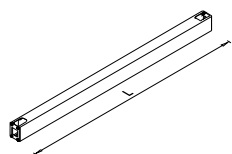
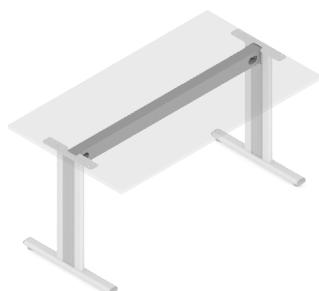
**SPOJKA STOLOVÝCH NÔH**

Obj. číslo:	Typ:	Farba:	Dĺžka:
<b>80-30014</b>	SPOJKA 800	RAL 9006G	703 mm
<b>80-30015</b>	SPOJKA 1000	RAL 9006G	903 mm
<b>80-30017</b>	SPOJKA 1200	RAL 9006G	1103 mm

## VOGA - SYSTÉM DESK BAR - PRÍSLUŠENSTVO

### SPOJKY STOLOVÝCH NÔH

Obj. číslo:	Typ:	Farba:	Dĺžka:
80-30019	SPOJKA 1400	RAL 9006G	1303 mm
80-30021	SPOJKA 1600	RAL 9006G	1503 mm
80-30022	SPOJKA 1800	RAL 9006G	1703 mm
80-30023	SPOJKA 2000	RAL 9006G	1903 mm

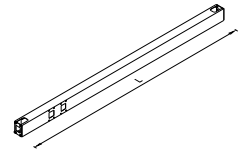
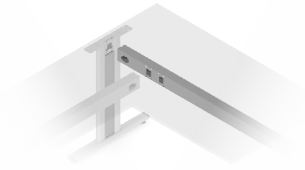

### NOSNÁ DOSKA 90°

Obj. číslo:	Farba:	Dĺžka:	Šírka:	Výška:
80-30879	RAL 9006G	190 mm	190 mm	92 mm

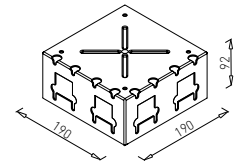
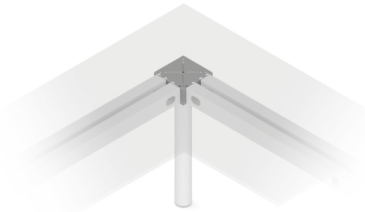

### NOSNÍK DOSKY, 152 mm

Obj. číslo:	Farba:	Dĺžka:	Šírka:	Výška:
80-30076	RAL 9006G	152 mm	62 mm	85 mm

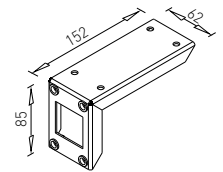
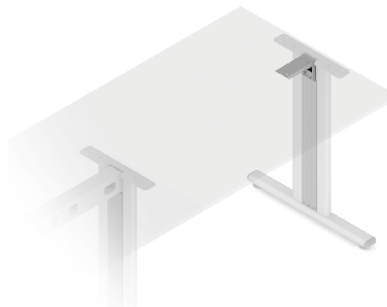

### NOSNÍK PODNOŽE, 101 mm

Obj. číslo:	Farba:	Dĺžka:	Šírka:	Výška:
80-30901	RAL 9006G	101 mm	49 mm	88 mm

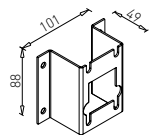
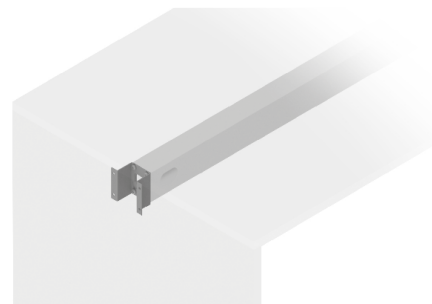

### POLICA NA POČÍTAČ

Obj. číslo:	Farba:	Dĺžka:	Šírka:	Výška:
80-30056	RAL 9006G	520 mm	215 mm	80 mm

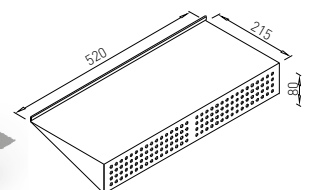
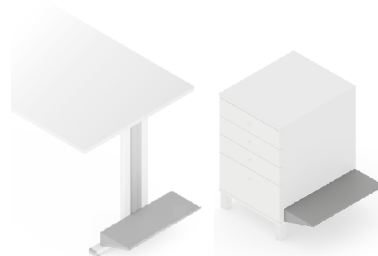

## VOGA - SYSTÉM DESK BAR

UHLOVÉ 90° RIEŠENIE PRE NOHY TYPU  
TEMPO, TEND, WORK, TILL

dĺžka spojovníka - 400 mm = dĺžka stolovej dosky

dĺžka spojovníka      dĺžka stolovej dosky

800 mm                  400 mm

1000 mm                600 mm

1200 mm                800 mm

1400 mm                1000 mm

1600 mm                1200 mm

1800 mm                1400 mm

2000 mm                1600 mm

dĺžka spojovníka = dĺžka stolovej dosky

dĺžka spojovníka      dĺžka stolovej dosky

1400 mm                1400 mm

1600 mm                1600 mm

1800 mm                1800 mm

2000 mm                2000 mm

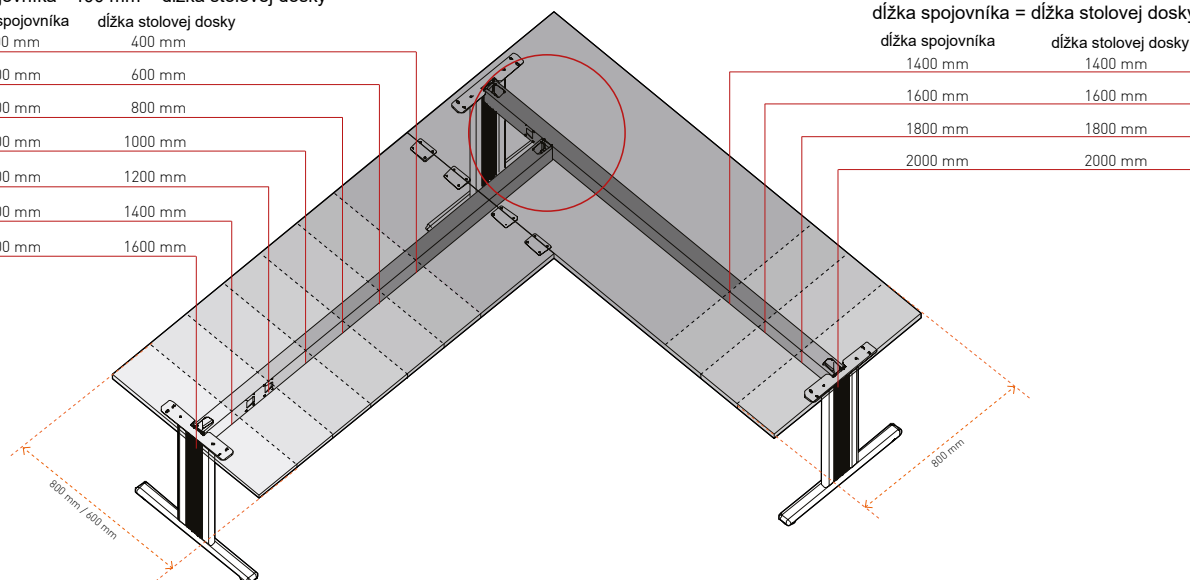
UHLOVÉ 90° RIEŠENIE PRE NOHY TYPU  
TEMPO, TEND, WORK, TILL

dĺžka spojovníka - 400 mm = dĺžka stolovej dosky

dĺžka spojovníka      dĺžka stolovej dosky

800 mm                  400 mm

1000 mm                600 mm

1200 mm                800 mm

1400 mm                1000 mm

1600 mm                1200 mm

1800 mm                1400 mm

2000 mm                1600 mm

dĺžka spojovníka + 400 mm = dĺžka stolovej dosky

dĺžka spojovníka      dĺžka stolovej dosky

800 mm                  1200 mm

1000 mm                1400 mm

1200 mm                1600 mm

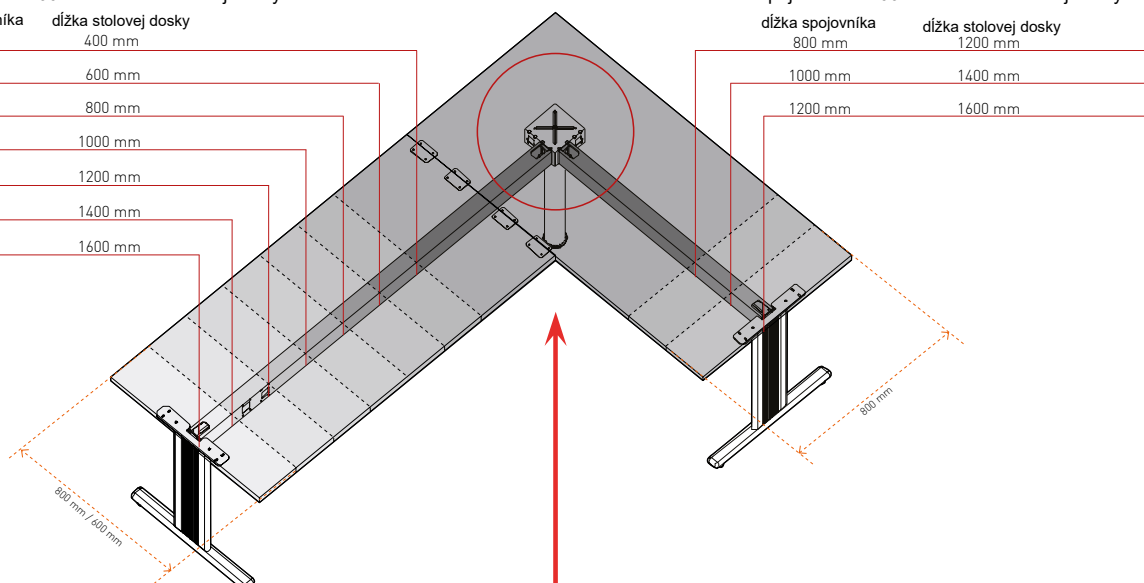

Pre správnu montáž odporúčame použiť:  
 Stĺp Terra obj. č.: 80-30115  
 Čap ø 80 obj.č.: 80-30276



## VOGA - SYSTÉM DESK BAR

### UHLOVÉ 90° RIEŠENIE PRE NOHY TYPU COMO, MARK

dĺžka spojovníka - 500 mm = dĺžka stolovej dosky

dĺžka spojovníka	dĺžka stolovej dosky
800 mm	300 mm
1000 mm	500 mm
1200 mm	700 mm
1400 mm	900 mm
1600 mm	1100 mm
1800 mm	1300 mm
2000 mm	1500 mm

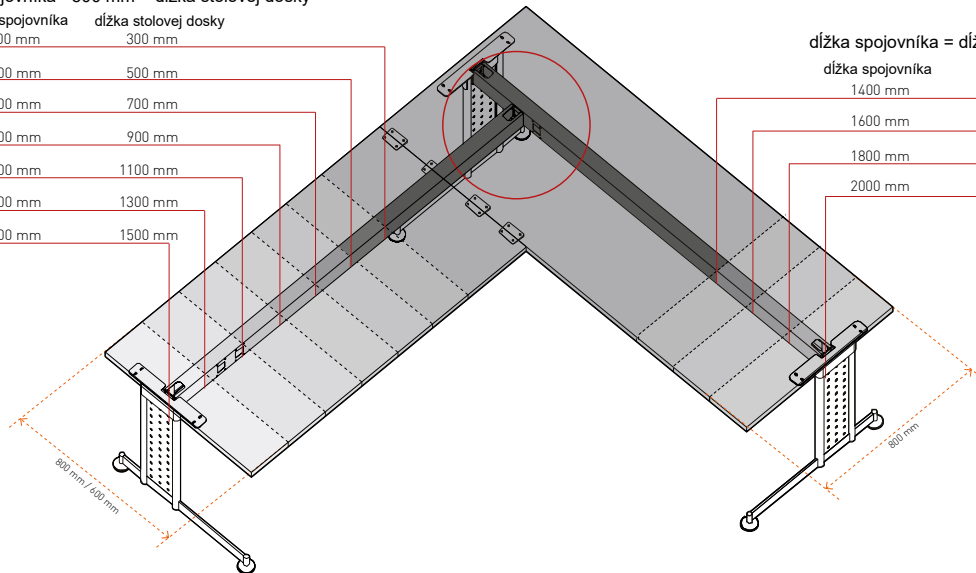

dĺžka spojovníka = dĺžka stolovej dosky

dĺžka spojovníka	dĺžka stolovej dosky
1400 mm	1400 mm
1600 mm	1600 mm
1800 mm	1800 mm
2000 mm	2000 mm

### UHLOVÉ 90° RIEŠENIE PRE NOHY TYPU COMO, MARK

dĺžka spojovníka - 400 mm = dĺžka stolovej dosky

dĺžka spojovníka	dĺžka stolovej dosky
800 mm	400 mm
1000 mm	600 mm
1200 mm	800 mm
1400 mm	1000 mm
1600 mm	1200 mm
1800 mm	1400 mm
2000 mm	1600 mm

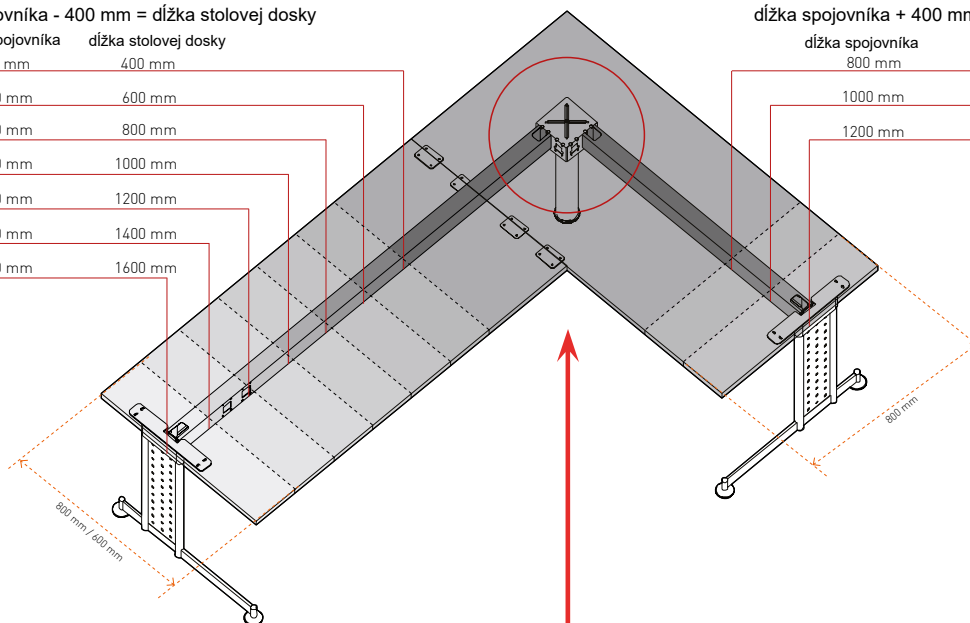

dĺžka spojovníka + 400 mm = dĺžka stolovej dosky

dĺžka spojovníka	dĺžka stolovej dosky
800 mm	1200 mm
1000 mm	1400 mm
1200 mm	1600 mm

Pre správnu montáž odporúčame použiť:

Stĺp Terra **obj. č.: 80-30115**

Čap ø 80 **obj.č.: 80-30276**

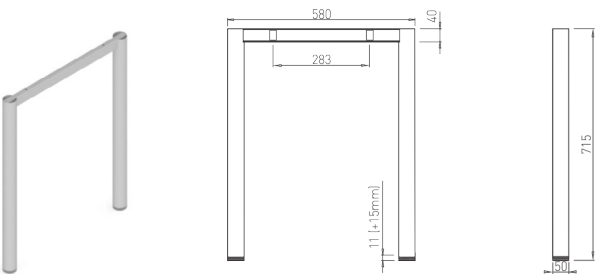
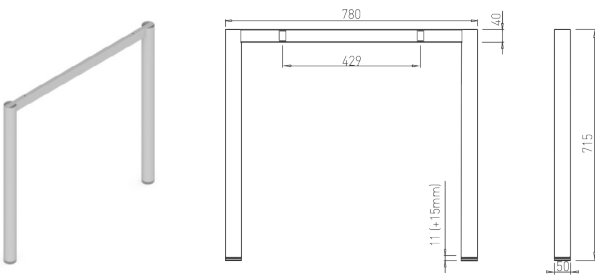
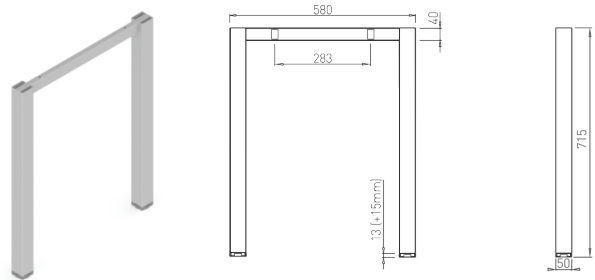
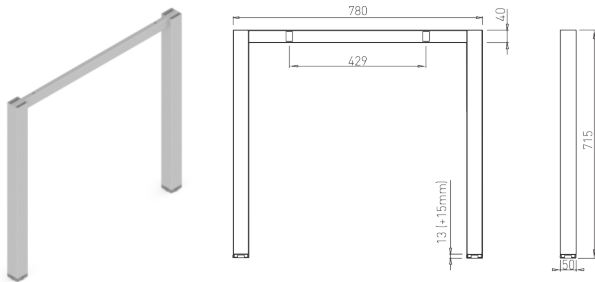

## VOGA - SYSTÉM HIDE

**HUBO 50 / 800**

Výšková regulácia: 10 mm

Obj. číslo:	Farba:	Šírka:	Výška:	Šírka stola:
80-31420	RAL 9006G	780 mm	715 mm	800 mm

**HUBO 50 / 600**

Výšková regulácia: 10 mm

Obj. číslo:	Farba:	Šírka:	Výška:	Šírka stola:
80-31419	RAL 9006G	580 mm	715 mm	600 mm

**HOXO 50 / 800**

Výšková regulácia: 10 mm

Obj. číslo:	Farba:	Šírka:	Výška:	Šírka stola:
80-31431	RAL 9006G	780 mm	715 mm	800 mm

**HOXO 50 / 600**

Výšková regulácia: 10 mm

Obj. číslo:	Farba:	Šírka:	Výška:	Šírka stola:
80-31430	RAL 9006G	580 mm	715 mm	600 mm

## VOGA - SYSTÉM HIDE



### HIWOOD FE ø 50 / 800

Obj. číslo:	Farba:	Šírka:	Výška:	Šírka stola min.:
80-31495	RAL 9005FE	742 mm	715 mm	800 mm

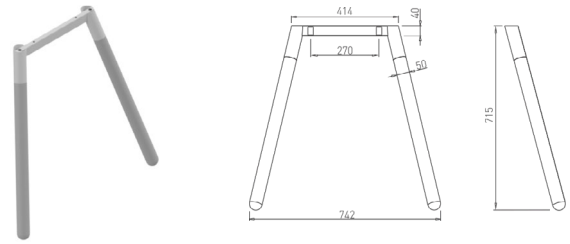

### HIWOOD FE 70 x 30 / 800

Obj. číslo:	Farba:	Šírka:	Výška:	Šírka stola min.:
80-31494	RAL 9005FE	772 mm	715 mm	800 mm

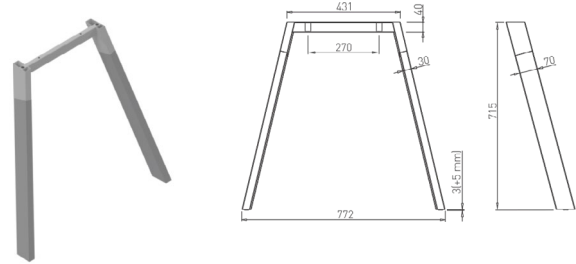

### HQ 800

Výšková regulácia: 10 mm

Obj. číslo:	Farba:	Šírka:	Výška:	Šírka stola:
80-31433	RAL 9006G	790 mm	715 mm	800 mm

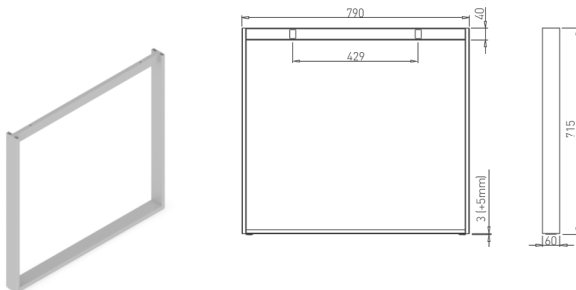

### HQ 600

Výšková regulácia: 5 mm

Obj. číslo:	Farba:	Šírka:	Výška:	Šírka stola:
80-31432	RAL 9006G	590 mm	715 mm	600 mm

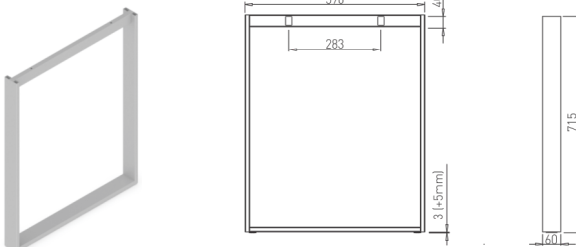

### HQ 800 HV

Výšková regulácia: 5 mm

Obj. číslo:	Farba:	Šírka:	Výška:	Šírka stola:
80-31435	RAL 9006G	790 mm	680 - 825 mm	800 mm

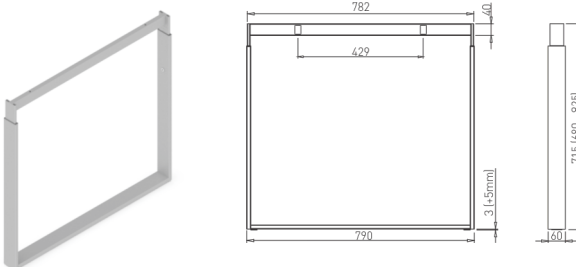

### HQ 600 HV

Výšková regulácia: 5 mm

Obj. číslo:	Farba:	Šírka:	Výška:	Šírka stola:
80-31434	RAL 9006G	590 mm	680 - 825 mm	600 mm

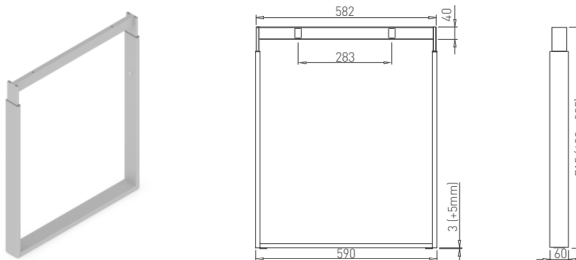

## VOGA - SYSTÉM HIDE - PRÍSLUŠENSTVO

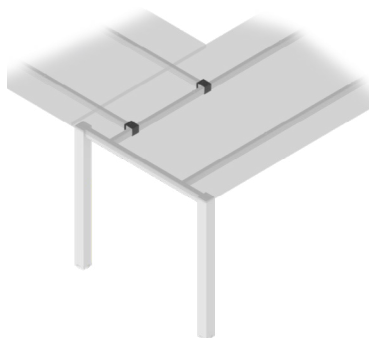
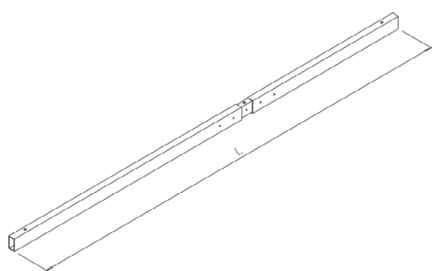
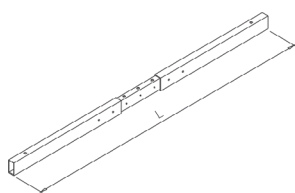
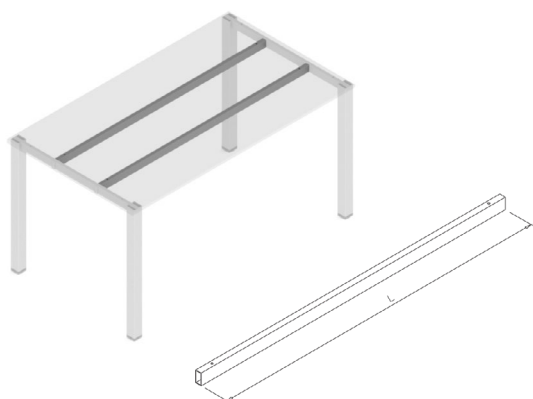

2 X

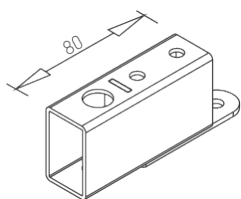
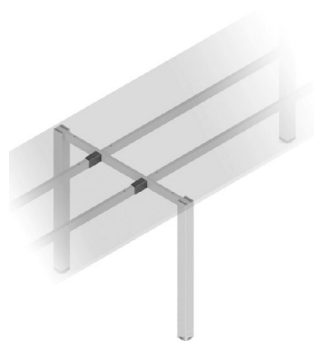
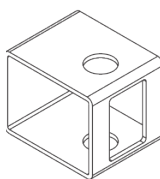

## PRIEČNIK HIDE

Výšková regulácia: 5 mm

Obj. číslo:	Typ:	Dĺžka L:
80-31496	CONNECTOR HIDE 600	551 mm
80-31421	CONNECTOR HIDE 800	751 mm
80-31422	CONNECTOR HIDE 1000	951 mm
80-31423	CONNECTOR HIDE 1200	1151 mm
80-31424	CONNECTOR HIDE 1400	1351 mm
80-31425	CONNECTOR HIDE 1600	1551 mm
80-31426	CONNECTOR HIDE 1800	1451 mm
80-31427	CONNECTOR HIDE 2000	1951 mm

## PRIEČNIK HIDE 900 - 1400 TELESKOPICKÝ

Obj. číslo:	Farba:	Dĺžka L:
80-31439	RAL 9006G	900 - 1400 mm

## PRIEČNIK HIDE 1500 - 2000 TELESKOPICKÝ

Obj. číslo:	Farba:	Dĺžka L:
80-31438	RAL 9006G	1500 - 2000 mm

## ROHOVÁ SPOJKA HIDE

Obj. číslo:	Farba:
80-31436	RAL 9006G

## PREDLŽOVACIA SPOJKA HIDE

Pri následnom namontovaní stolových dosiek sa vyhneme prídavným nohám pomocou spojovacieho nástavca HIDE

Obj. číslo:	Farba:
80-31440	RAL 9006G

## VOGA - SYSTÉM HIDE - PRÍSLUŠENSTVO

### NOSNÍK HIDE

Pevné spojenie štvorcových profilov medzi zásuvkou a doskou stola  
 Pomocou podpery HIDE stabilizuje spojenie s nohou na opačnej strane stola  
 Element sa používa na stolové dosky šírky 600 a 800 mm

Obj. číslo:

Farba:

80-31485

RAL 9006G

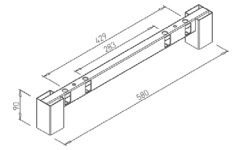
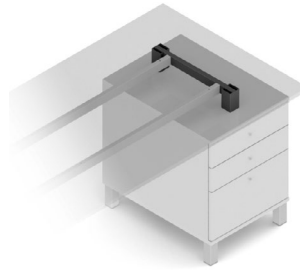

### DRŽIAK POČÍTAČA

Držiak ponúka stabilný a funkčný rám na upevnenie počítača pod dosku stola

Možno ho použiť aj bez drevenej police

Balené v kartónovej kriabici (2 kusy)

Obj. číslo:

Farba:

Materiál:

80-30846

RAL 7015

plast

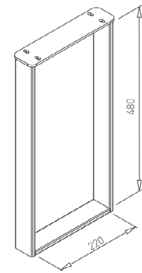

### DRÔTENÁ POLICA

Polica umožňuje umiestnenie káblov a ďalších prvkov pod dosku stola so zavesením police na konektory EDGE bez nutnosti vŕtania

Obj. číslo:

Farba:

Materiál:

80-31498

RAL 7015

plast

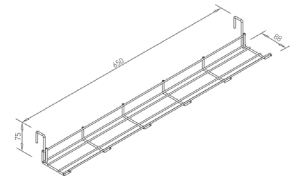

### UHLOVÉ 90° RIEŠENIE PRE NOHY TYPU HUBO, HOXO, HIWOOD, HQ

dĺžka spojovníka - 200 mm = dĺžka stolovej dosky

dĺžka spojovníka      dĺžka stolovej dosky

800 mm	600 mm
1000 mm	800 mm
1200 mm	1000 mm
1400 mm	1200 mm
1600 mm	1400 mm
1800 mm	1600 mm
2000 mm	1800 mm

dĺžka spojovníka = dĺžka stolovej dosky

dĺžka spojovníka      dĺžka stolovej dosky

1400 mm	1400 mm
1600 mm	1600 mm
1800 mm	1800 mm
2000 mm	2000 mm

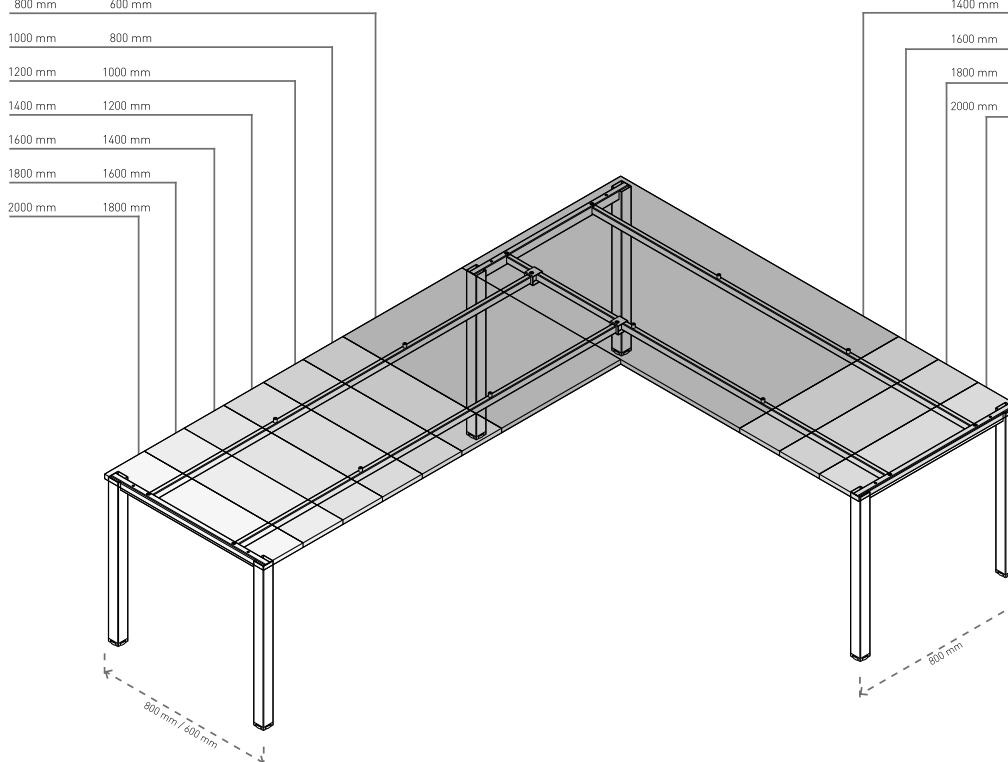

## VOGA - SYSTÉM EDGE

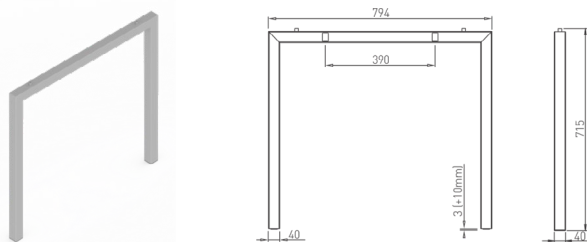
**HAVANA 40 / 800**

Výšková regulácia: 10 mm

Obj. číslo:	Farba:	Šírka:	Výška:	Šírka stola:
80-31429	RAL 9006G	794 mm	715 mm	800 mm

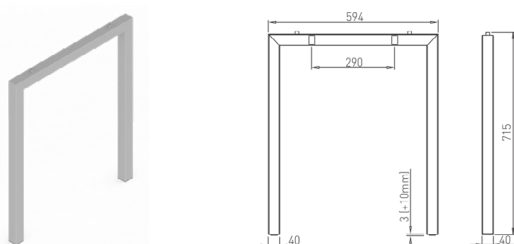
**HAVANA 40 / 600**

Výšková regulácia: 10 mm

Obj. číslo:	Farba:	Šírka:	Výška:	Šírka stola:
80-31428	RAL 9006G	594 mm	715 mm	600 mm

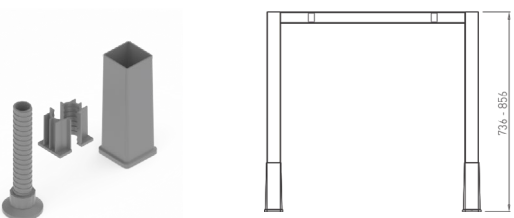
**PLUG CUBO / HV (50)  
VÝŠKOVO NASTAVITELNÁ KONCOVKA**

Iba pre podnože HAVANA

Pre jednu nohu sú potrebné dve sady zástrčiek

Pomocou hmoždínok je možné nastaviť výšku stola od 736 do 856 mm

Obj. číslo:	Farba:	Šírka:	Výška:	Šírka stola:
80-30709	RAL 9006G	780 mm	715 mm	800 mm

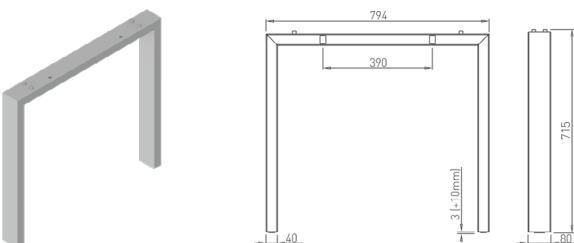
**FLAT 800**

Výšková regulácia: 10 mm

Obj. číslo:	Farba:	Šírka:	Výška:	Šírka stola:
80-31490	RAL 9006G	794 mm	715 mm	800 mm

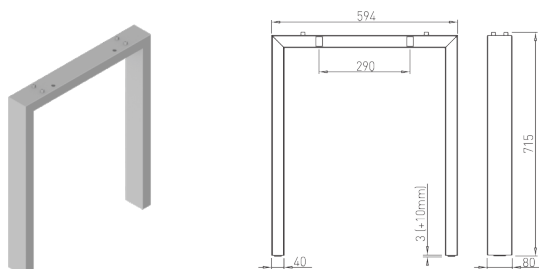
**FLAT 600**

Výšková regulácia: 10 mm

Obj. číslo:	Farba:	Šírka:	Výška:	Šírka stola:
80-31489	RAL 9006G	594 mm	715 mm	600 mm

## VOGA - SYSTÉM EDGE - PRÍSLUŠENSTVO

### PRIEČNIK EDGE

Obj. číslo:		Dĺžka L:
80-30831	EDGE 600	590 mm
80-30832	EDGE 800	790 mm
80-30833	EDGE 1000	990 mm
80-30834	EDGE 1200	1190 mm
80-30835	EDGE 1400	1390 mm
80-30836	EDGE 1600	1590 mm
80-30837	EDGE 1800	1790 mm
80-30838	EDGE 2000	1990 mm

### PRIEČNIK EDGE 900 - 1400 TELESKOPICKÝ

Obj. číslo:	Farba:	Dĺžka L:
80-31491	RAL 9006G	900 - 1400 mm

### PRIEČNIK EDGE 1500 - 2000 TELESKOPICKÝ

Obj. číslo:	Farba:	Dĺžka L:
80-31492	RAL 9006G	1500 - 1200 mm

### ROHOVÁ SPOJKA EDGE

Obj. číslo:	Farba:
80-31437	RAL 9006G

### PREDLŽOVACIA SPOJKA EDGE

Pri následnom namontovaní stolových dosiek sa vyhneme ďalšej nohe pomocou rozšírenia konektorov EDGE

Obj. číslo:	Farba:
80-31493	RAL 9006G

### NOSNÍK EDGE

Používa sa ako pevné spojenie štvorcových profilov medzi zásuvkou a doskou stola

Pomocou podpery EDGE vytvára stabilné spojenie s nohou na opačnej strane stola

Element sa používa na stolové dosky šírky 600 a 800 mm

Obj. číslo:	Farba:
80-31497	RAL 9006G

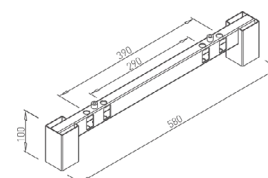
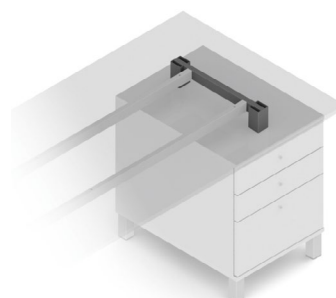
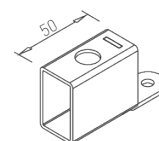
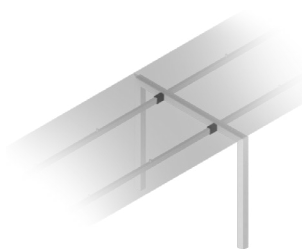
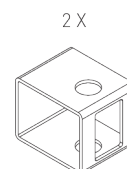
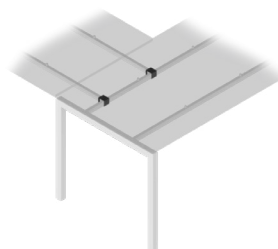
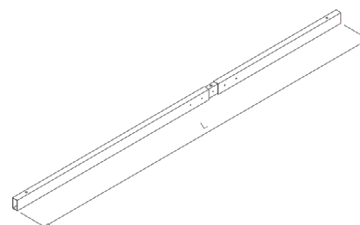
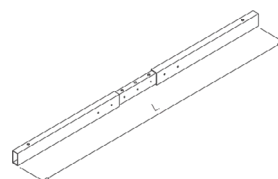
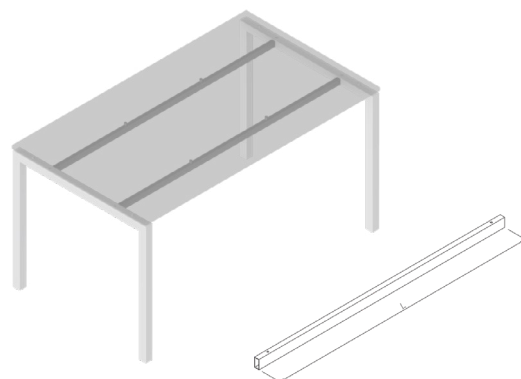

## VOGA - SYSTÉM EDGE - PRÍSLUŠENSTVO

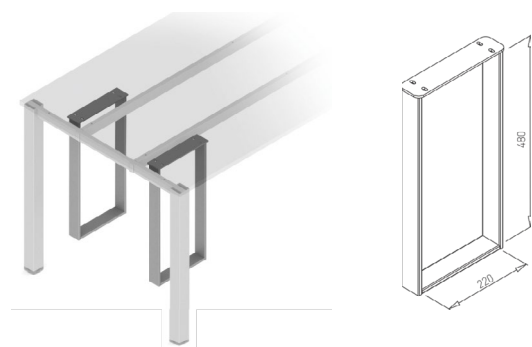

## DRŽIAK POČÍTAČA EDGE

Držiak ponúka stabilný a funkčný rám na upevnenie počítača pod doskou stola

Možno ho použiť aj bez drevenej police

Balené v kartónovej krabici (2 kusy)

Obj. číslo:

Farba:

80-30846

RAL 7015

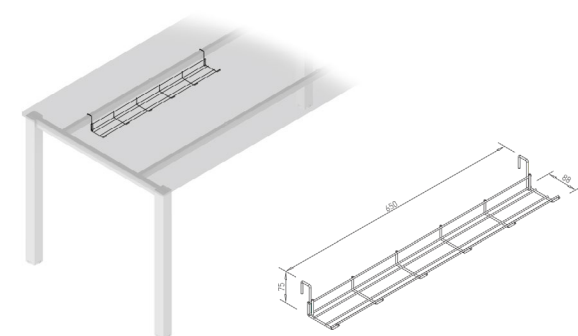

## DRÔTENÁ POLICA EDGE

Polica umožňuje umiestnenie káblov a ďalších prvkov pod doskou stola so zavesením police na konektory EDGE bez nutnosti vŕtania

Obj. číslo:

Farba:

80-31498

RAL 7015

## UHLOVÉ 90° RIEŠENIE PRE NOHY TYPU HAVANA, FLAT

dĺžka spojovníka - 200 mm = dĺžka stolovej dosky

dĺžka spojovníka      dĺžka stolovej dosky

800 mm	600 mm
1000 mm	800 mm
1200 mm	1000 mm
1400 mm	1200 mm
1600 mm	1400 mm
1800 mm	1600 mm
2000 mm	1800 mm

dĺžka spojovníka = dĺžka stolovej dosky

dĺžka spojovníka      dĺžka stolovej dosky

1400 mm	1400 mm
1600 mm	1600 mm
1800 mm	1800 mm
2000 mm	2000 mm

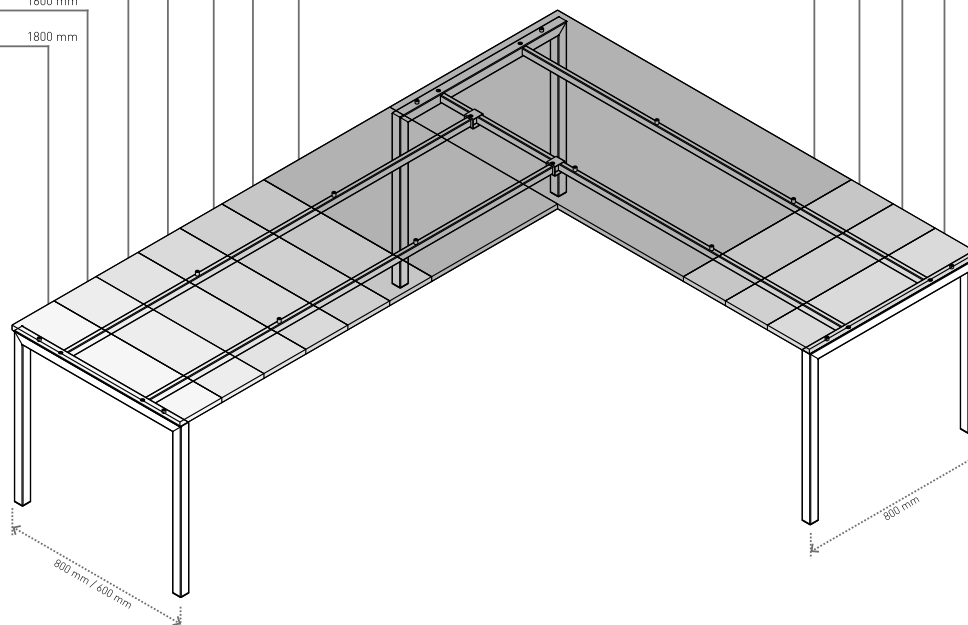



## VOGA - SYSTÉM BACK



### AVA C 700

Obj. číslo:	Farba:	Šírka podnože:	Výška:
80-30172	RAL 9006G	695 mm	715 mm

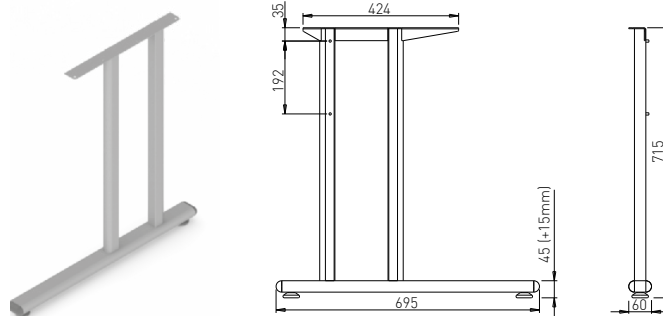

### AVA C 500

Obj. číslo:	Farba:	Šírka podnože:	Výška:
80-30173	RAL 9006G	495 mm	715 mm

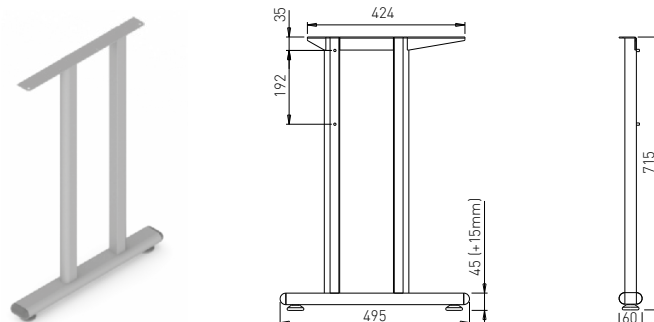

## VOGA - SYSTÉM BACK

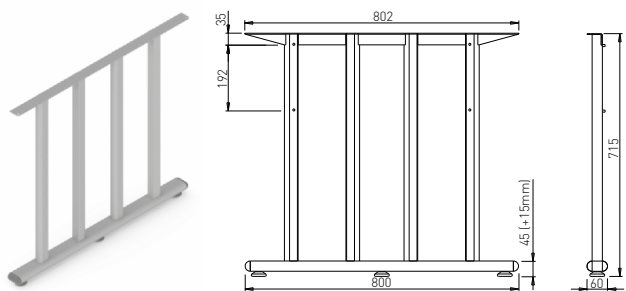

## AVA CC 800

Obj. číslo:	Farba:	Šírka podnože:	Výška:
80-30251	RAL 9006G	800 mm	715 mm

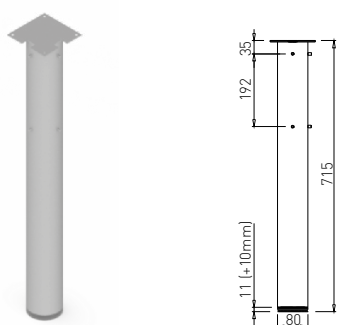

## ROHOVÁ NOHA STOLA ø 80 / 90 mm

Obj. číslo:	Farba:	Dĺžka:
80-30174	RAL 9006G	715 mm

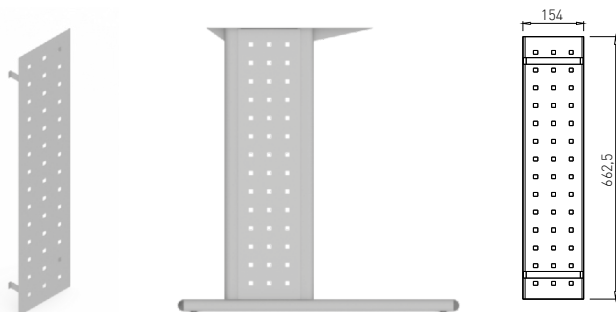

## KOVOVÁ VLOŽKA PERFOROVANÁ

Obj. číslo:	Farba:	Dĺžka:	Šírka:
80-30220	RAL 9006G	662,5 mm	154 mm

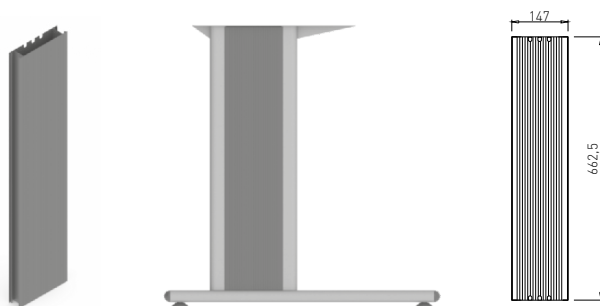

## PLASTOVÁ VLOŽKA

Obj. číslo:	Farba:	Dĺžka:	Šírka:
80-30219	RAL 7015 plastic	662,5 mm	147 mm
80-20219	RAL 9005 plastic	662,5 mm	147 mm

## VOGA - SYSTÉM KOTA



### KOTA 80 x 80 mm

Obj. číslo:	Farba:	Šírka:	Výška:
80-30900	RAL 9006G	80 mm	715 mm

### KOTA ø 80 mm

Obj. číslo:	Farba:	Šírka:	Výška:
80-31376	RAL 9006G	80 mm	715 mm

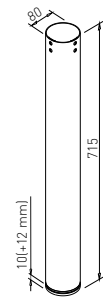

### SPOJOVNÍKY KOTA

Obj. číslo:	Typ:	Farba:	Dĺžka:
80-31377	SPOJOVNÍK KOTA 800	RAL 9006G	630 mm
80-31378	SPOJOVNÍK KOTA 900	RAL 9006G	730 mm
80-31379	SPOJOVNÍK KOTA 1000	RAL 9006G	830 mm
80-31380	SPOJOVNÍK KOTA 1200	RAL 9006G	1030 mm
80-31381	SPOJOVNÍK KOTA 1400	RAL 9006G	1230 mm
80-31382	SPOJOVNÍK KOTA 1600	RAL 9006G	1430 mm
80-31383	SPOJOVNÍK KOTA 1800	RAL 9006G	1630 mm
80-31384	SPOJOVNÍK KOTA 2000	RAL 9006G	1830 mm

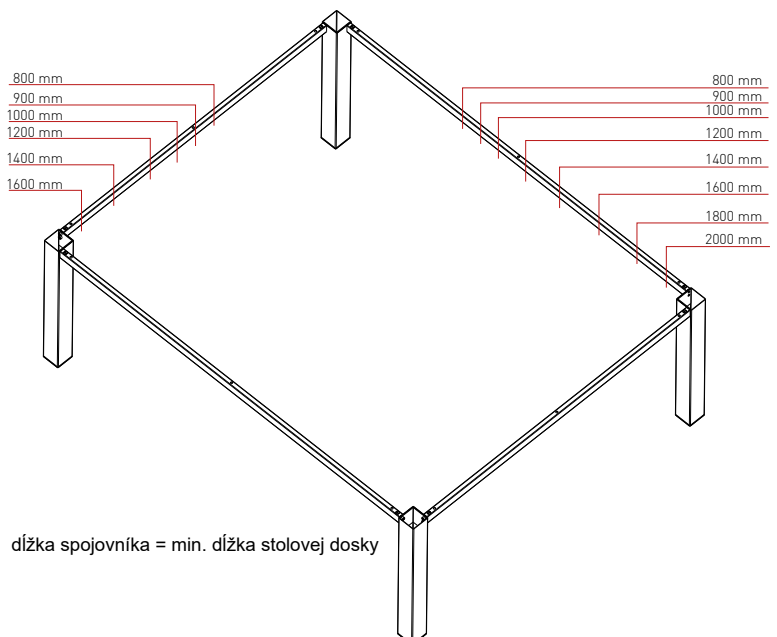

dĺžka spojovníka = min. dĺžka stolovej dosky



## VOGA - SYSTÉM SOLO

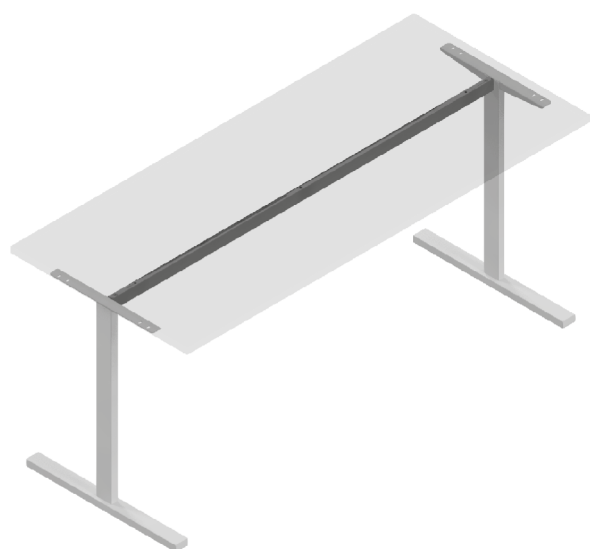
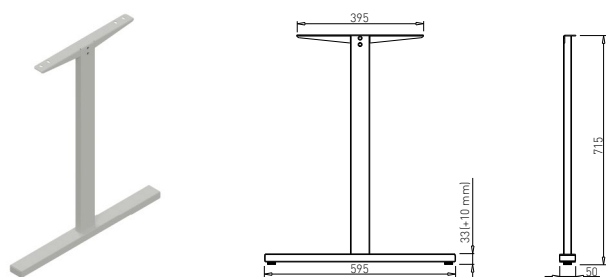
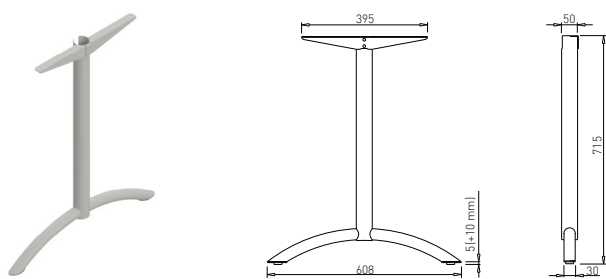

## SOLO ARCH

Obj. číslo:	Farba:	Šírka podnože:	Výška:
80-30793	RAL 9006G	608 mm	715 mm

## SOLO SIMPLE

Obj. číslo:	Farba:	Šírka podnože:	Výška:
80-30792	RAL 9006G	595 mm	715 mm

## SPOJOVNÍKY SOLO

Obj. číslo:	Typ:	Farba:	Dĺžka:
80-30818	SPOJOVNÍK SOLO 800	RAL 9006G	710 mm
80-30819	SPOJOVNÍK SOLO 1000	RAL 9006G	910 mm
80-30816	SPOJOVNÍK SOLO 1200	RAL 9006G	1110 mm
80-30814	SPOJOVNÍK SOLO 1400	RAL 9006G	1310 mm
80-30815	SPOJOVNÍK SOLO 1600	RAL 9006G	1510 mm
80-30974	SPOJOVNÍK SOLO 1800	RAL 9006G	1710 mm
80-30126	SPOJOVNÍK SOLO 2000	RAL 9006G	1910 mm

## SYSTEM ELTIPLA - ELEKTRICKÉ PODNOŽE



### ELTIPLA 2

Obj. číslo:	Šírka podnože:	Farba:	Rozmer stolovej dosky:	Výška:
80-30987	700 mm	RAL 9006	1200 - 2200 mm	617 - 1217 mm

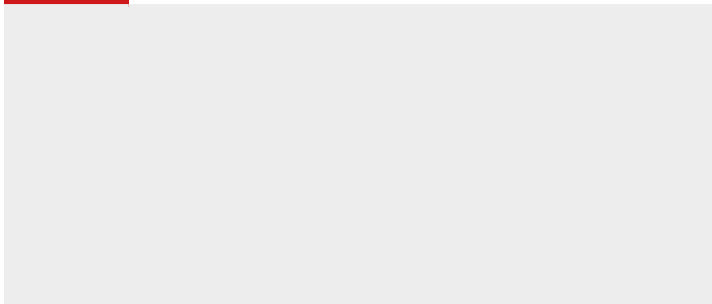

### ELTIPLA 3

Obj. číslo:	Šírka podnože:	Farba:	Rozmer stolovej dosky:	Výška:
80-31265	700 mm	RAL 9006	1400 - 2200 mm	617 - 1217 mm

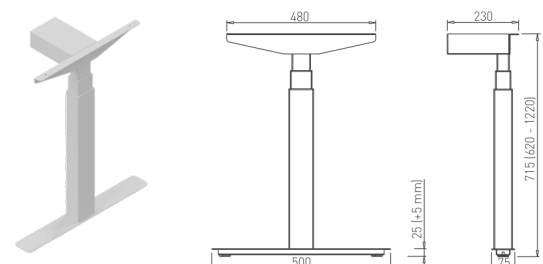
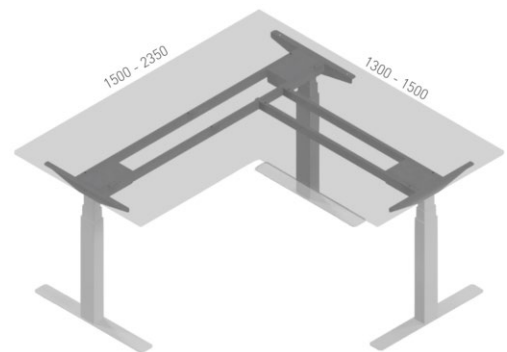
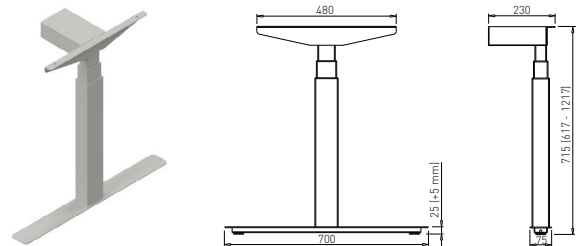
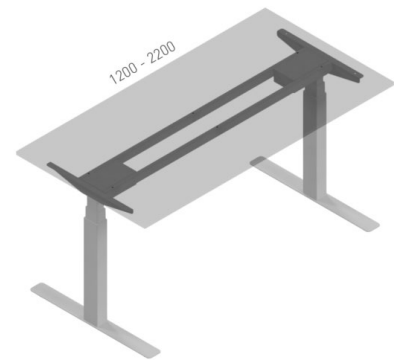
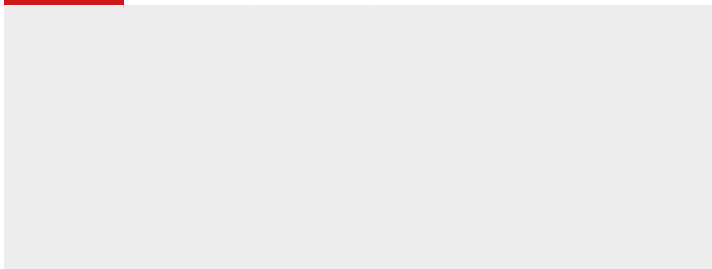

## VOGA - ŠPECIÁLNE PODNOŽE

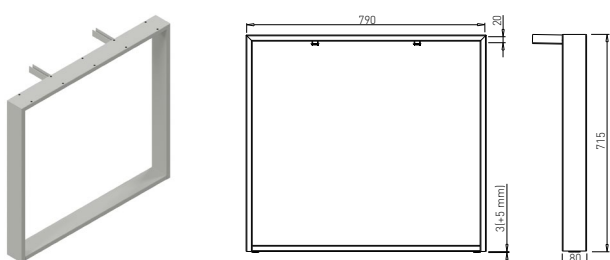
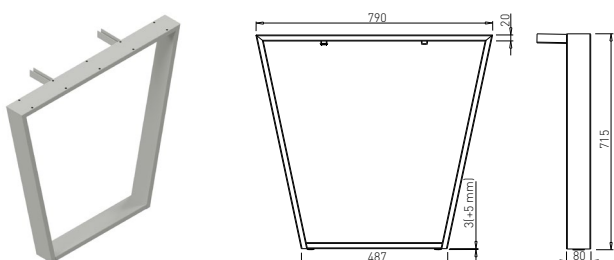
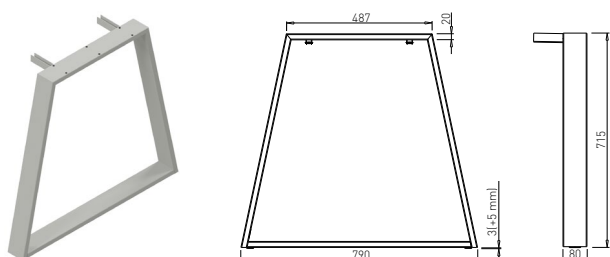
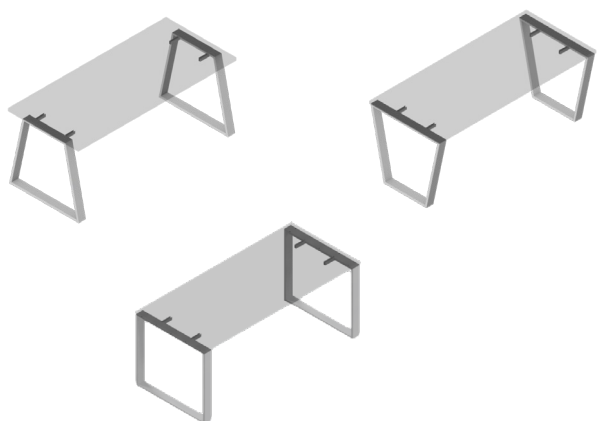
**A-NOHA**

Obj. číslo:	Farba:	Šírka podnože:	Výška:
80-30654	RAL 9006G	790 mm	715 mm

**U-NOHA**

Obj. číslo:	Farba:	Šírka podnože:	Výška:
80-30655	RAL 9006G	487 mm	715 mm

**O-NOHA**

Obj. číslo:	Farba:	Šírka podnože:	Výška:
80-30656	RAL 9006G	790 mm	715 mm

## VOGA - STOLOVÉ NOHY



**SIXTY**

Obj. číslo:	Farba:	Výška:	Priemer:
80-30012	RAL 9006G	715 mm	60 mm



**SIXTY K**

Obj. číslo:	Farba:	Výška:	Priemer:
80-30018	RAL 9006G	715 mm	60 mm



**SIXTY CLUB**

Obj. číslo:	Farba:	Výška:	Priemer:
80-30398	RAL 9006G	430 mm	60 mm



**SIXTY BAR**

Obj. číslo:	Farba:	Výška:	Priemer:
80-30132	RAL 9006G	1100 mm	60 mm

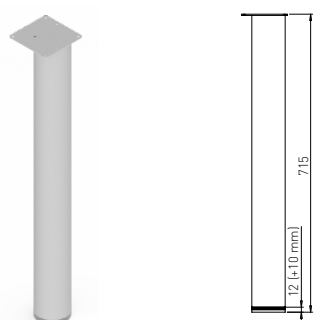
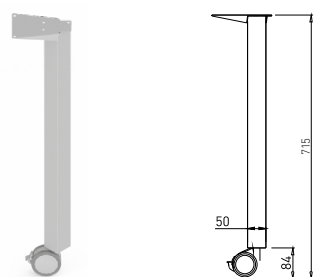
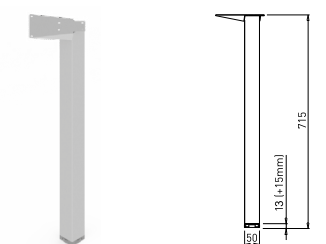
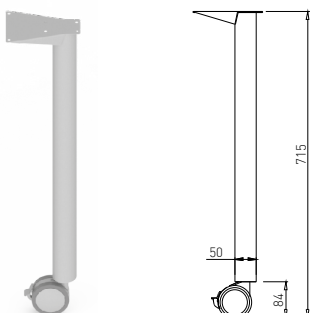
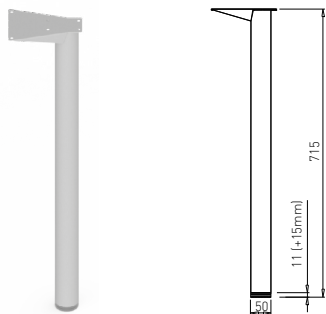

## VOGA - STOLOVÉ NOHY

**FIFTY**

Obj. číslo:	Farba:	Výška:	Priemer:
80-30052	RAL 9006G	715 mm	50 mm

**FIFTY-K**

Obj. číslo:	Farba:	Výška:	Priemer:
80-30055	RAL 9006G	715 mm	50 mm

**CUB IN**

Obj. číslo:	Farba:	Výška:	Šírka:
80-30385	RAL 9006G	715 mm	50 mm

**CUB IN K**

Obj. číslo:	Farba:	Výška:	Šírka:
80-30387	RAL 9006G	715 mm	50 mm

**EIGHTY**

Obj. číslo:	Farba:	Výška:	Priemer:
80-30080	RAL 9006G	715 mm	80 mm



## VOGA - STOLOVÉ NOHY



### ROMB 50

Obj. číslo:	Farba:	Výška:	Šírka:
80-30896	hliník	715 mm	50 mm

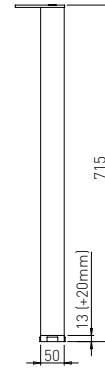

### ROMB 50 CLUB

Obj. číslo:	Farba:	Výška:	Šírka:
80-30897	hliník	430 mm	50 mm

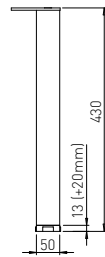

### ROMB 80

Obj. číslo:	Farba:	Výška:	Šírka:
80-30973	hliník	715 mm	80 mm

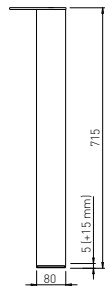

### ROMB 80 CLUB

Obj. číslo:	Farba:	Výška:	Šírka:
80-31266	hliník	430 mm	80 mm

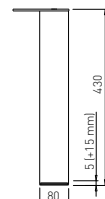

## T-LINE - STOLOVÉ NOHY

### STOLOVÁ NOHA

Obj. číslo:	Farba:	Výška:	Priemer:
24-33112061	RAL 9006G	710 mm	60 mm
24-33112062	matná čierna	710 mm	60 mm
24-33112060	chróm	710 mm	60 mm

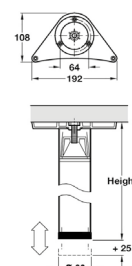

## VOGA - SKLOPNÉ STOLOVÉ NOHY

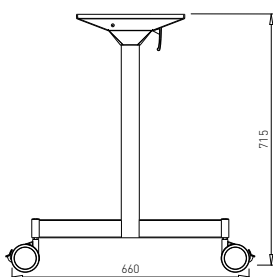
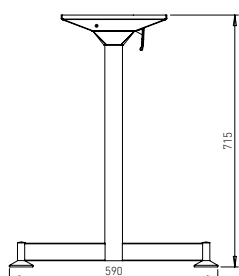

## PARK Z - SKLOPNÁ NOHA

Obj. číslo: Farba: Šírka podnože: Výška:

80-30848

RAL 9006G

590 mm

715 mm

## PARK Z - SKLOPNÁ NOHA S KOLIESKAMI

Obj. číslo: Farba: Šírka podnože: Výška:

80-31253

RAL 9006G

660 mm

715 mm

VOGA - SKLOPNÉ STOLOVÉ NOHY

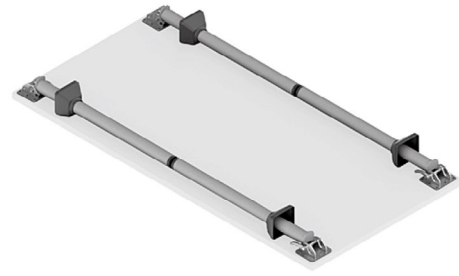

FIFTY Z - SKLOPNÁ NOHA

Obj. číslo:	Farba:	Dĺžka:	Priemer:
80-30736	RAL 9006G	715 mm	50 mm

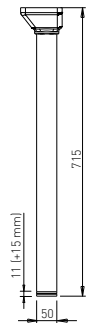

SKIP - SKLOPNÁ NOHA

Obj. číslo:	Farba:	Šírka:	Výška:
80-31269	RAL 9006G	790 mm	715 mm

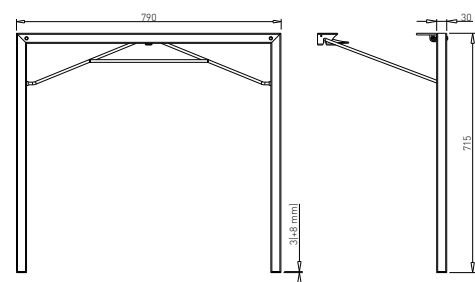

## VOGA - CENTRÁLNE PODNOŽE MIX



## CENTRÁLNA PODNOŽ DRON

Jednoduchá montáž - všetky podnože sú vyrobené z niekoľkých častí navzájom spojených skrutkami, sú mimoriadne stabilné

Montáž podstavca umožňuje minimálny objem pre logistiku, jednoduchý a ľahký spôsob ich prepravy

Sú navrhnuté tak, aby najmenej prekážali okoliu

Jedinečnosťou systému podnoží MIX je dizajn, funkčnosť, flexibilita a stabilita

Obj. číslo:

80-31504

Farba:

RAL 9006G

Šírka podnože:

803 mm

Výška:

715 mm

Pre stolové dosky okrúhle:

ø 850 - 1000 mm

Pre stolové dosky obdĺnikové:

600 - 800 mm

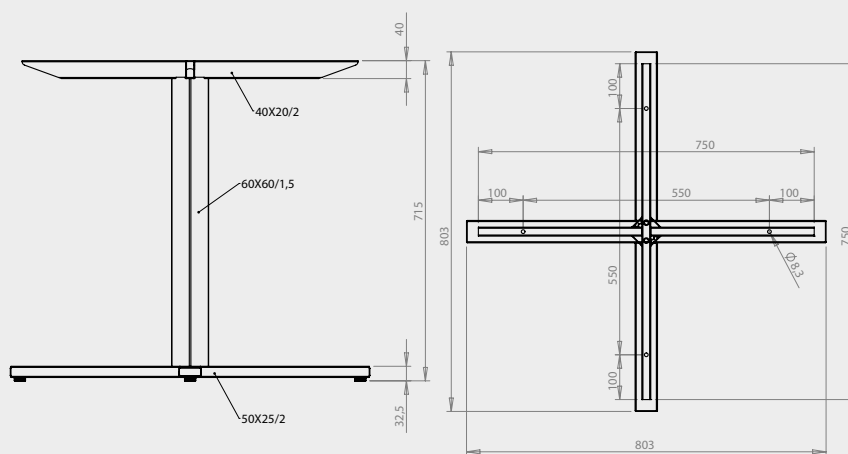
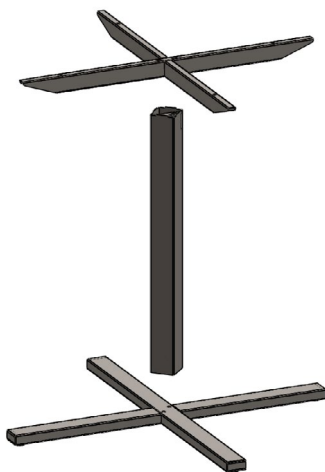
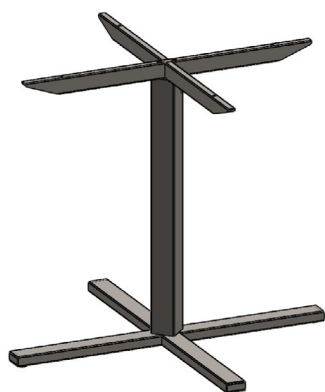

VOGA - CENTRÁLNE PODNOŽE MIX



**CENTRÁLNA PODNOŽ HI DRON**

Jednoduchá montáž - všetky podnože sú vyrobené z niekoľkých častí navzájom spojených skrutkami, sú mimoriadne stabilné

Montáž podstavca umožňuje minimálny objem pre logistiku, jednoduchý a ľahký spôsob ich prepravy

Sú navrhnuté tak, aby najmenej prekážali okoliu

Jedinečnosťou systému podnoží MIX je dizajn, funkčnosť, flexibilita a stabilita

<b>Obj. číslo:</b>	<b>80-31505</b>
<b>Farba:</b>	RAL 9006G
<b>Šírka podnože:</b>	800 mm
<b>Výška:</b>	715 mm
<b>Pre stolové dosky okrúhle:</b>	ø 850 - 1000 mm
<b>Pre stolové dosky obdĺžnikové:</b>	600 - 800 mm

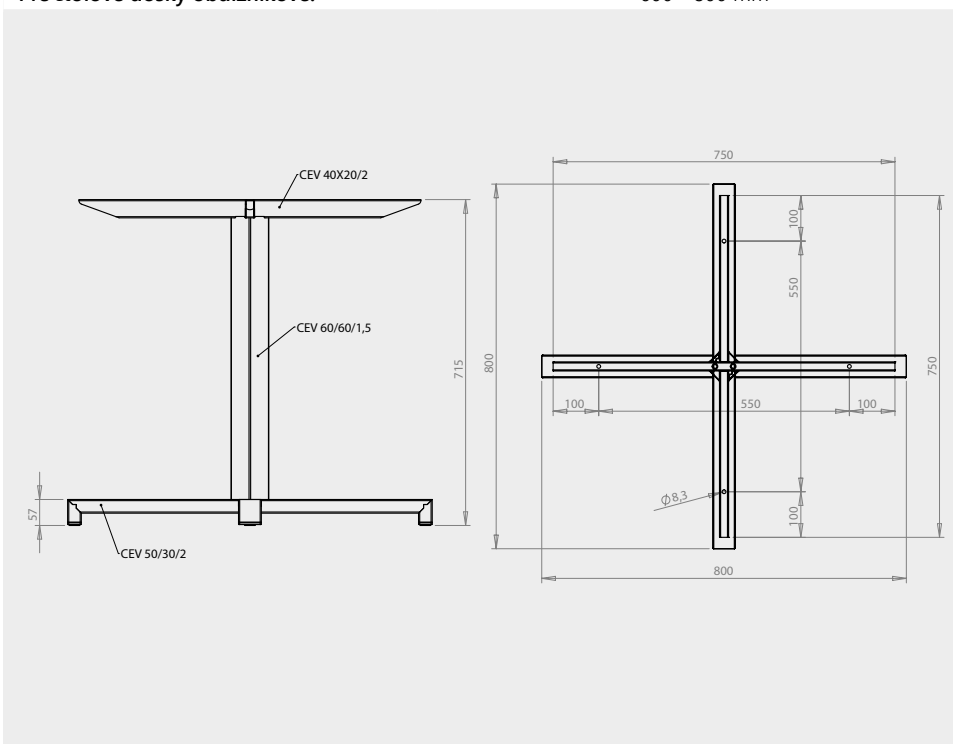
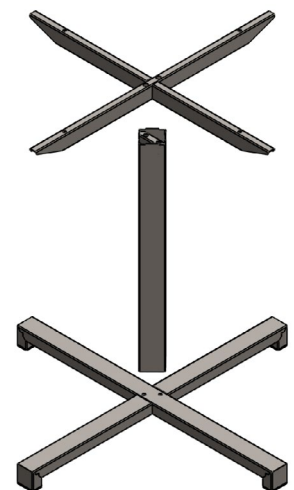
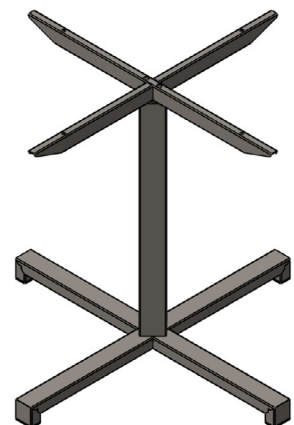

## VOGA - CENTRÁLNE PODNOŽE

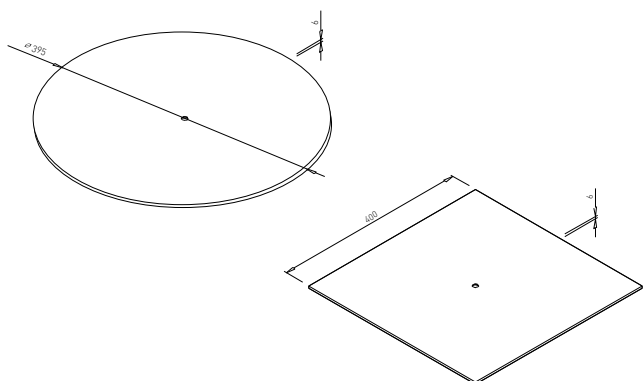
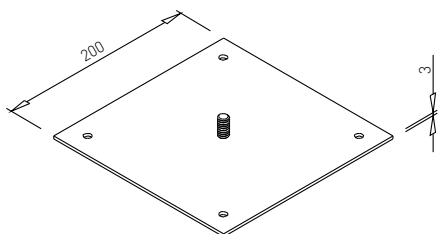

## HORNÁ DOSKA TERRA

Obj. číslo:	Rozmer:	Rozmer stolovej dosky:	Farba:
80-30120	200 x 200 mm	ø 600 mm, 500 x 500 mm ø 800 mm, 700 x 700 mm	RAL 9006G
80-30162	330 x 330 mm	ø 800 mm, 700 x 700 mm ø 850 mm, 750 x 750 mm	RAL 9006G

## SPODNÁ DOSKA TERRA

Obj. číslo:	Rozmer:	Rozmer stolovej dosky:	Farba:
80-30117	ø 400 mm	ø 600 mm 500 x 500 mm	RAL 9006G
80-30118	ø 500 mm	ø 800 mm 700 x 700 mm	RAL 9006G
80-30119	ø 600 mm	ø 850 mm 750 x 750 mm	RAL 9006G
80-30632	400 x 400 mm	ø 800 mm 700 x 700 mm	RAL 9006G

## VOGA - CENTRÁLNE PODNOŽE

### STĹPY TERRA, ø 80 mm

Obj. číslo:	Typ:	Farba:	Rozmer stolovej dosky (mm):	Výška:
80-30115	TERRA ø 80	RAL 9006G	ø 600, ø 800, ø 850 500 x 500, 700 x 700 750 x 750	706 mm
80-30841	TERRA ø 80 BAR	RAL 9006G	ø 600, ø 800, ø 850, 500 x 500, 700 x 700 750 x 750	1091 mm
80-30009	TERRA ø 80 HV	RAL 9006G	ø 800, ø 850 700 x 700, 750 x 750	570 - 820 mm
80-31106	TERRA ø 80 INOX	INOX	ø 800 700 x 700	706 mm
80-30630	TERRA 50 x 50 mm	RAL 9006G	ø 800 700 x 700	706 mm

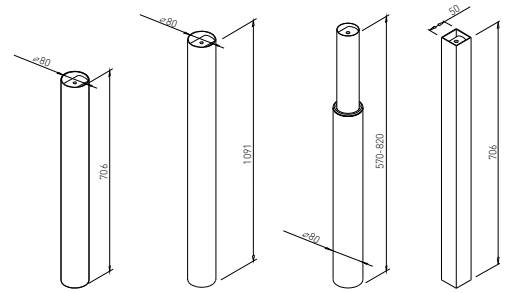

### ČAP ø 80

Obj. číslo:	Farba:	Priemer:
80-30276	RAL 7015 plastic	80 mm
80-20276	RAL 9005 plastic	80 mm

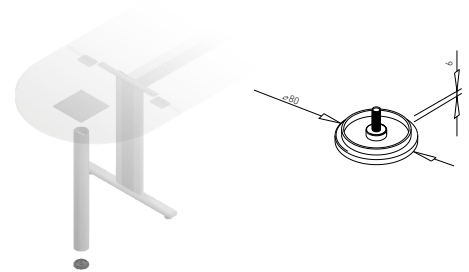

### KRYT SPODNEJ DOSKY TERRA inox ø 500

Obj. číslo:	Farba:	Priemer:
80-31105	INOX	500 mm

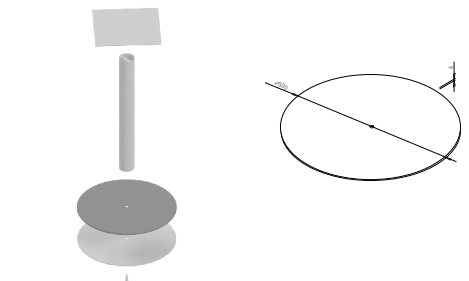

### DRŽIAK NA SKLO

Obj. číslo:	Farba:	Priemer:
80-20675	hliník	89 mm

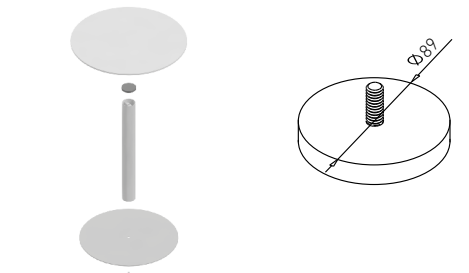

### HORNÝ KRÍŽ BOMA

Obj. číslo:	Dĺžka:	Rozmer stolovej dosky:	Farba:
80-30279	598 mm	ø 900 mm, ø 1100 mm 800 x 800 mm 900 x 900 mm	RAL 9006G
80-30013	798 mm	ø 1300 mm, 1050 x 1050 mm	RAL 9006G
80-30278	998 mm	ø 1600 mm, 1200 x 1200 mm	RAL 9006G

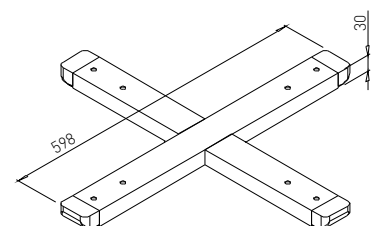

## VOGA - CENTRÁLNE PODNOŽE

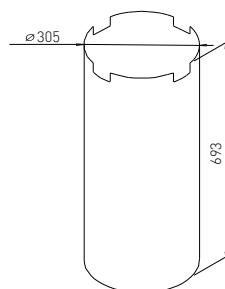
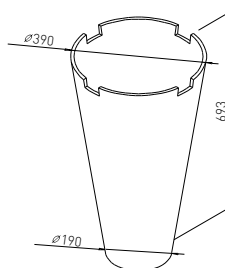
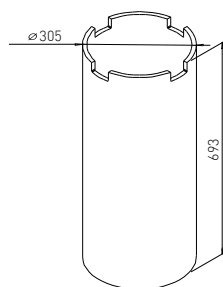
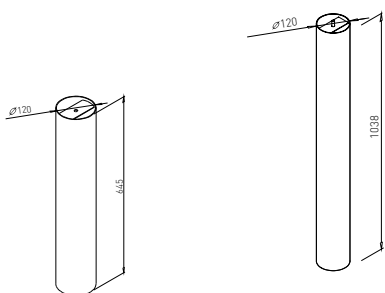
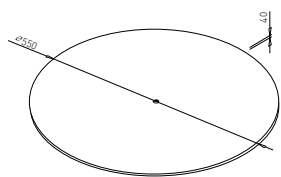

## SPODNÁ DOSKA BOMA

Obj. číslo:	Priemer:	Rozmer stolovej dosky:	Farba:
80-30011	ø 500 mm	ø 900, 800 x 800 mm	RAL 9006G
80-30163	ø 620 mm	ø 1100, 900 x 900 mm	RAL 9006G
80-30064	ø 720 mm	ø 1300, 1050 x 1050 mm	RAL 9006G
80-30072	ø 820 mm	ø 1600, 1200 x 1200 mm	RAL 9006G

## STĽP BOMA KOVOVÝ, VALEC

Obj. číslo:	Priemer:	Farba:	Rozmer stolovej dosky:	Výška:
80-30283	ø 120 mm	RAL 9006G	ø 900, 800 x 800 mm	645 mm
80-30284	ø 120 mm	RAL 9006G	ø 1100, 900 x 900 mm	654 mm
80-30839	ø 120 mm	RAL 9006G	ø 1100, 900 x 900 mm	1038 mm

## STĽP BOMA DREVENÝ, VALEC

Obj. číslo:	Priemer:	Materiál:	Rozmer stolovej dosky:	Výška:
80-20280	ø 305 mm	drevo (buk)	ø 1100 mm 900 x 900 mm	693 mm
80-20281	ø 335 mm	drevo (buk)	ø 1300 mm 1050 x 1050 mm	679 mm
80-20282	ø 405 mm	drevo (buk)	ø 1600, 1200 x 1200 mm	669 mm

## STĽP BOMA DREVENÝ, KUŽEL

Obj. číslo:	Priemer horná / dolná podstava:	Materiál:	Rozmer stolovej dosky:	Výška:
80-20634	ø 390 / ø 190 mm	drevo (buk)	ø 1100 mm 900 x 900 mm	693 mm
80-20635	ø 390 / ø 190 mm	drevo (buk)	ø 1300 mm 1050 x 1050 mm	679 mm
80-20636	ø 390 / ø 190 mm	drevo (buk)	ø 1600 mm 1200 x 1200 mm	669 mm

## STĽP BOMA ŽELEZNÝ, VALEC

Obj. číslo:	Priemer:	Farba:	Rozmer stolovej dosky:	Výška:
80-31203	ø 305 mm	RAL 9006G	ø 1100, 900 x 900 mm	693 mm
80-31204	ø 335 mm	RAL 9006G	ø 1300, 1050 x 1050 mm	679 mm
80-31205	ø 395 mm	RAL 9006G	ø 1600, 1200 x 1200 mm	669 mm



## VOGA - CENTRÁLNE PODNOŽE

### HORNÁ PLATŇA GAST

Obj. číslo:	Rozmer:	Rozmer stolovej dosky / Výška:	Farba:
80-31248 	300 x 300 mm	900 x 900 mm / 715 mm 800 x 800 mm / 1100 mm 900 x 1400 mm / 715 mm 800 x 1200 mm / 1100 mm	RAL 9006G

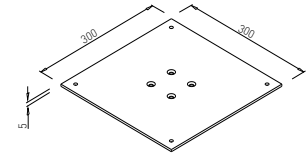

### HORNÁ PLATŇA GAST S DRŽIAKOM

Obj. číslo:	Rozmer:	Rozmer stolovej dosky / výška:	Farba:
80-31264 	300 x 320 mm	900 x 1400 mm / 715 mm 800 x 1200 mm / 1100 mm	RAL 9006G

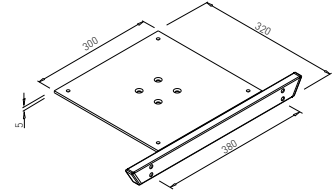

### DOLNÁ PLATŇA GAST

Obj. číslo:	Rozmer:	Rozmer stolovej dosky / výška:	Farba:
80-31247 	495 x 495 mm	900 x 900 mm / 715 mm 800 x 800 mm / 1100 mm	RAL 9006G
80-31261 	695 x 495 mm	900 x 1400 mm / 715 mm 800 x 1200 mm / 1100 mm	RAL 9006G
80-31262 	595 x 295 mm	900 x 1400 mm / 715 mm 800 x 1200 mm / 1100 mm	RAL 9006G

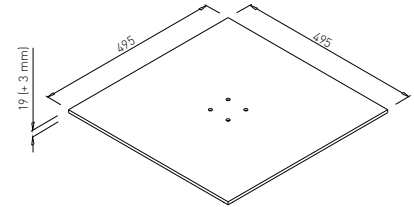

### STĽPY GAST

Obj. číslo:	Rozmer:	Výška:	Rozmer stolovej dosky / výška:	Farba:
80-31249 	80 x 80 mm	690 mm	900 x 900 mm / 715 mm 800 x 800 mm / 1100 mm 900 x 1400 mm / 715 mm 800 x 1200 mm / 1100 mm	RAL 9006G
80-31263 	80 x 80 mm	1076 mm	900 x 900 mm / 715 mm 800 x 800 mm / 1100 mm 900 x 1400 mm / 715 mm 800 x 1200 mm / 1100 mm	RAL 9006G

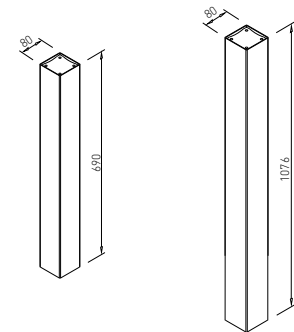

DĹŽKA SPOJOVNÍKA = DĹŽKA STOLOVEJ DOSKY - 800 mm

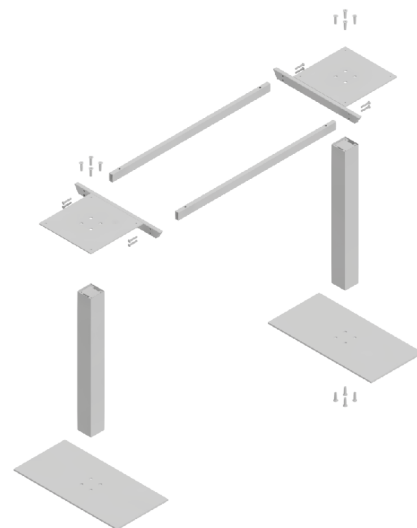
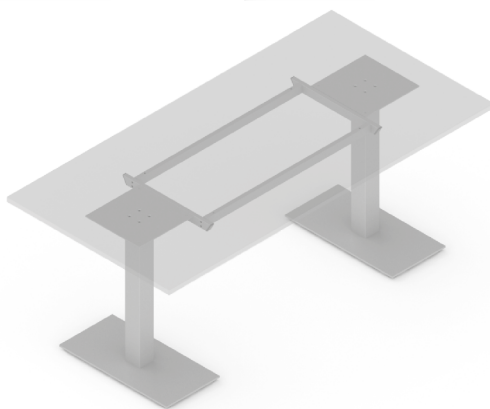

## VOGA - PRÍSLUŠENSTVO

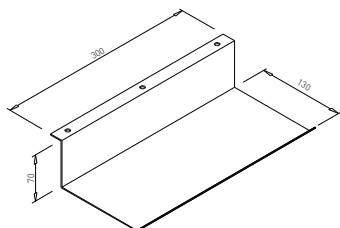
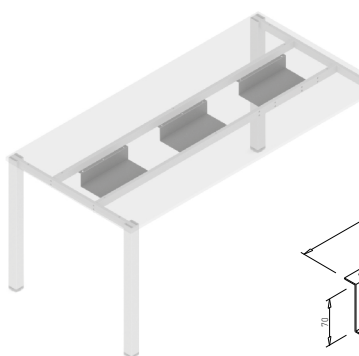
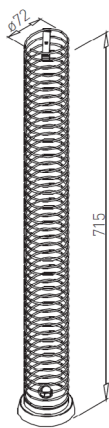
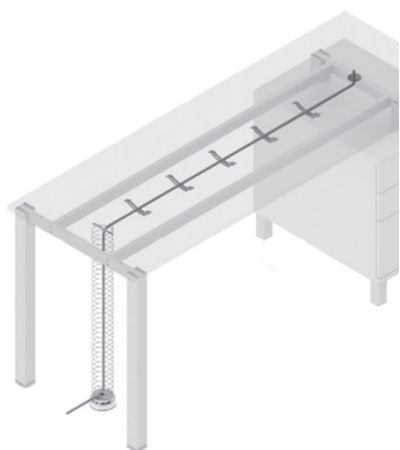
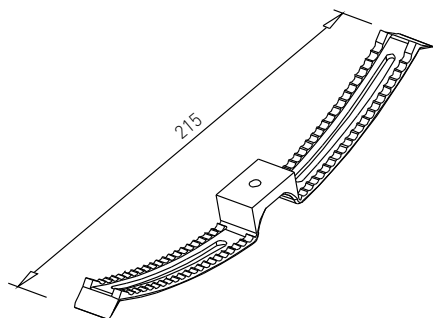
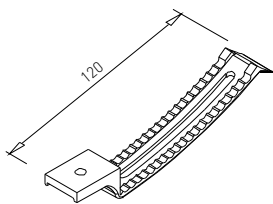

## DRŽIAK KÁBLOV

Obj. číslo:	Materiál:	Dĺžka:
80-20048	plast	120 mm

## DRŽIAK KÁBLOV DVOJITÝ

Obj. číslo:	Materiál:	Dĺžka:
80-20640	plast	215 mm

## TUBA NA KÁBLE

Obj. číslo:	Farba:	Priemer:	Výška:
80-30077	RAL 9006G	72 mm	715 mm

## POLICA NA KÁBLE

Obj. číslo:	Farba:	Rozmery:
80-30525	RAL 9006G	300 x 130 x 70 mm

## VOGA - PRÍSLUŠENSTVO



### UHLOVÝ SPOJOVNÍK

Obj. číslo:	Farba:	Rozmery:
80-30705	RAL 9006G	120 x 50 x 120 mm

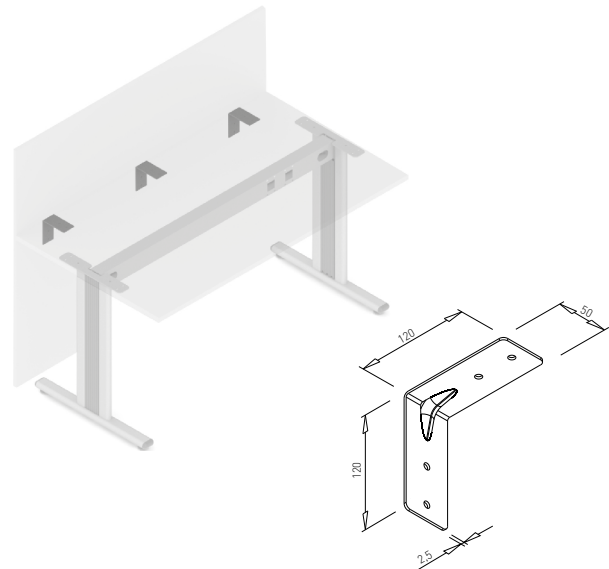

### CLONA

Obj. číslo:	Farba:	Rozmery:
80-30093	RAL 9006G	485 x 395 mm

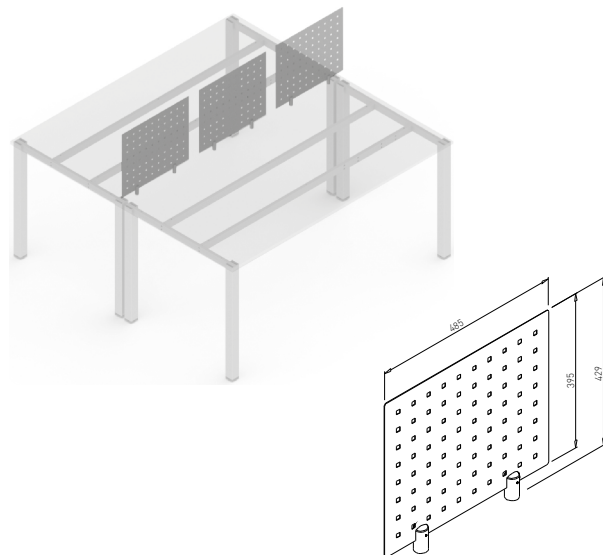

### POLICA NA POČÍTAČ

Obj. číslo:	Farba:	Rozmery:
80-30641	RAL 9006G	233 x 520 x 280 mm

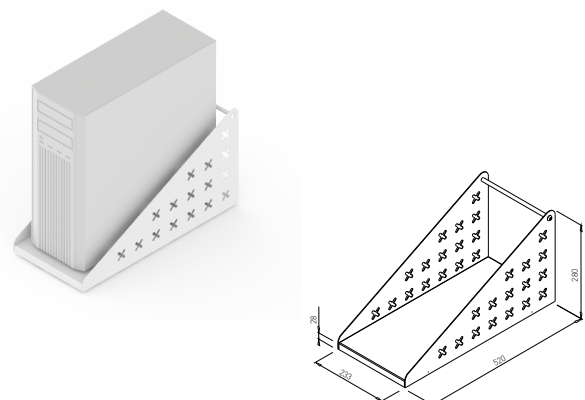

## VOGA - PRÍSLUŠENSTVO

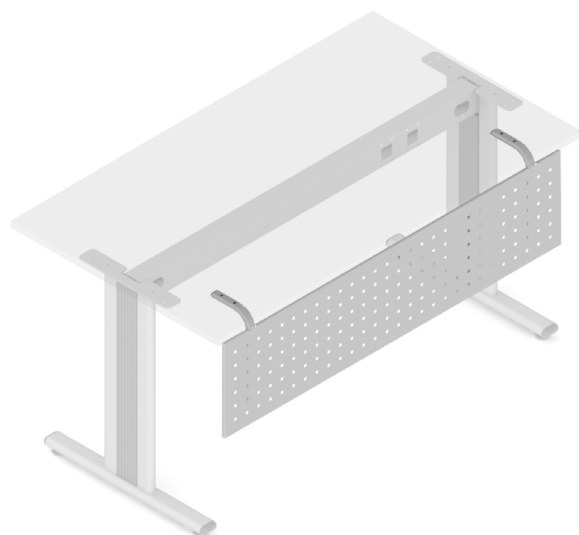
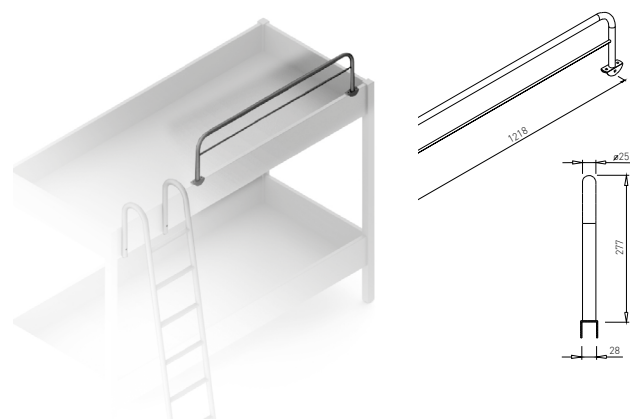

## REBRÍK NA POSCHODOVÚ POSTEĽ

Obj. číslo:	Farba:	Výška:	Šírka:
80-30692	RAL 9006G	1348 mm	356 mm

## ZÁBRADLIE NA POSCHODOVÚ POSTEĽ

Obj. číslo:	Farba:	Výška:	Dĺžka:
80-30693	RAL 9006G	1218 mm	277 mm

## CHRBÁT STOLA PERFOROVANÝ

Obj. číslo:	Typ:	Šírka:	Farba:
80-30165	BACK 800	700 mm	RAL 9006G
80-30166	BACK 1000	900 mm	RAL 9006G
80-30167	BACK 1200	1100 mm	RAL 9006G
80-30168	BACK 1400	1300 mm	RAL 9006G
80-30169	BACK 1600	1500 mm	RAL 9006G
80-30170	BACK 1800	1700 mm	RAL 9006G
80-30171	BACK 2000	1900 mm	RAL 9006G

## VOGA - PRÍSLUŠENSTVO



### NOSNÍK CHRBTÁ

Obj. číslo:	Farba:	Výška:	Hĺbka:
80-30030	RAL 9006G	305 mm	150 mm

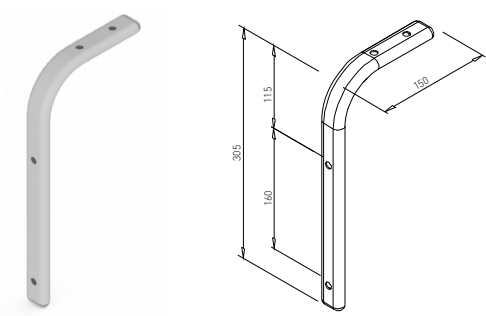

### VEŠIAK

Obj. číslo:	Farba:	Výška:
80-30393	RAL 9006G	1850 mm



### NOSNÍK POSTELNEJ OPIERKY

Obj. číslo:	Uhol:	Výška:	Farba:
80-30091	165°	140 + 350 mm	RAL 9006G

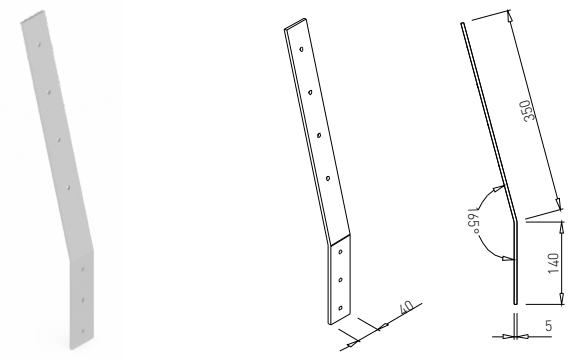

## SOKLOVÉ NOHY

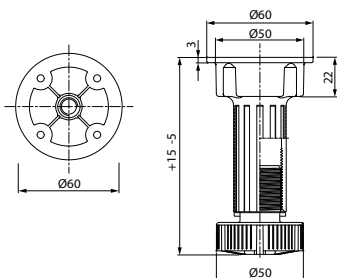
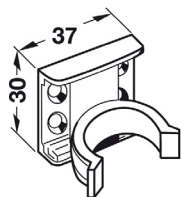
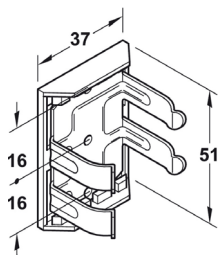
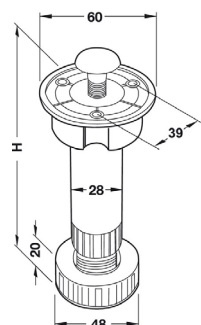

## SOKLOVÁ NOHA, HÄFELE

Obj. číslo:	Materiál:	Farba:	Výška:
71-63745308	plast	čierna	80 mm
71-63745326	plast	čierna	100 mm
71-63745344	plast	čierna	120 mm
71-63745371	plast	čierna	150 mm

## KLIP NA SOKEL, HÄFELE

Obj. číslo:	Určenie:	Šírka:	Výška:
71-63719906	drevené sokle	37 mm	51 mm

## DRŽIAK SOKLA SKRÁTENÝ, HÄFELE

Obj. číslo:	Určenie:	Materiál:	Šírka:	Výška:
71-63745906	drevené sokle	plast	30 mm	37 mm

## OTOČNÝ KLIP NA SOKEL

Obj. číslo:	Určenie:	Materiál:	Farba:
80-1001	hliníkové sokle	plast	čierna

## SOKLOVÁ NOHA, VOLPATO

Obj. číslo:	Materiál:	Farba:	Výška:
24-22101009	plast	čierna	100 mm
24-22101007	plast	čierna	120 mm
24-22101006	plast	čierna	120 mm
24-22101008	plast	čierna	150 mm



## SOKLOVÉ NOHY - AXILO

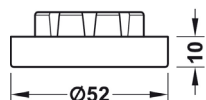
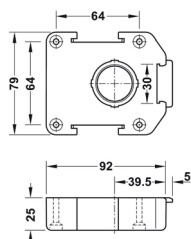
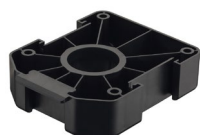
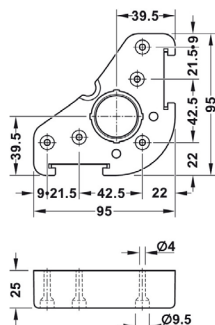
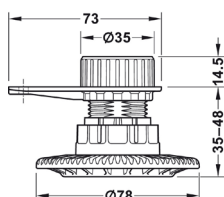
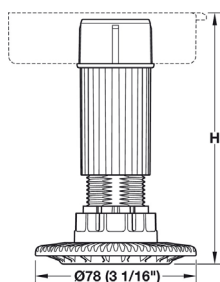

## SOKLOVÁ NOHA AXILO, NASTAVITEĽNÁ

Obj. číslo:	Výška:	Nastavenie výšky:	Farba:
71-63776351	60 mm	53 - 80 mm	čierna
71-63776352	80 mm	70 - 100 mm	čierna
71-63776353	100 mm	90 - 120 mm	čierna
71-63776354	125 mm	115 - 145 mm	čierna
71-63776355	150 mm	140 - 170 mm	čierna
71-63776356	180 mm	170 - 200 mm	čierna
71-63776357	200 mm	190 - 220 mm	čierna

## SOKLOVÁ NOHA AXILO S PRÍRUBOU, NASTAVITEĽNÁ

Obj. číslo:	Výška:	Nastavenie výšky:	Farba:
71-63776460	35 mm	35 - 48 mm	čierna

## SOKLOVÁ PODLOŽKA AXILO, ROHOVÁ

Obj. číslo:	Materiál:	Farba:
71-63738341	plast	čierna

Potrebné objednať spolu so skrutkovacou nohou Axilo.

## SOKLOVÁ PODLOŽKA AXILO

Obj. číslo:	Materiál:	Farba:
71-63776333	plast	čierna

Potrebné objednať spolu so skrutkovacou nohou Axilo.

## DIŠTANČNÁ PODLOŽKA AXILO

Obj. číslo:	Materiál:	Farba:	Priemer:
71-63776422	plast	čierna	52 mm

Používa sa pri mäkkých podkladoch.



## SOKLOVÉ NOHY - AXILO

### DRŽIAK SOKLA AXILO

Obj. číslo:	Určenie:	Veľkosť otvoru:	Výška základne:	Materiál:
71-63747491	drevené sokle	16 mm	5 - 10 mm	plast
71-63747490	drevené sokle	19 mm	5 - 10 mm	plast

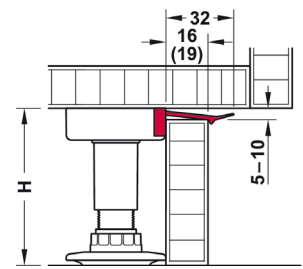

### KLIP NA SOKEL AXILO

Obj. číslo:	Určenie:	Materiál:	Farba:	Rozpätie skrutiek:
71-63738054	drevené sokle	plast	biela / čierna	40 mm

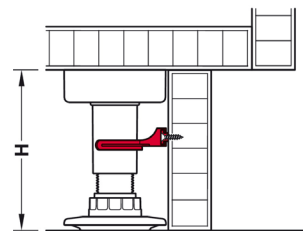

### NASTAVOVACÍ NÁSTROJ AXILO

Obj. číslo:	Dĺžka:	Výška uhla nastavenia:	Materiál:
71-63776360	660 mm	0 - 10°	plast

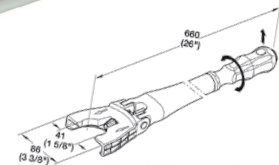

### PREDLŽOVACIE RAMENO PRE NASTAVOVACÍ NÁSTROJ AXILO

Obj. číslo:	Dĺžka:	Materiál:
71-63776361	323 mm	hliník / plast

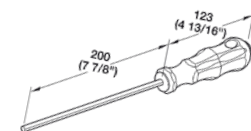

### NÁSTROJ AXILO 78, PRIAMY

Obj. číslo:	Dĺžka:	Materiál:
71-63776430	640 mm (pevná dĺžka)	hliník / plast

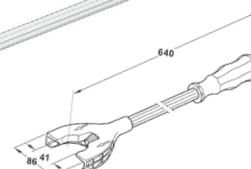
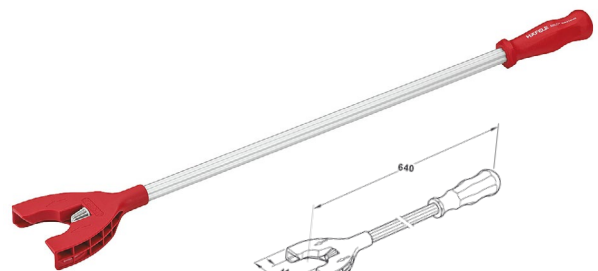

## VOGA - NÁBYTKOVÉ NOHY

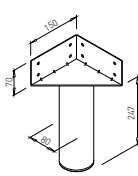
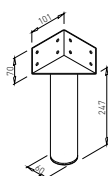
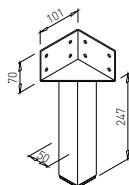
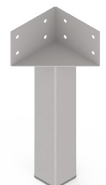
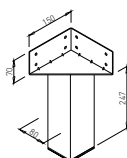
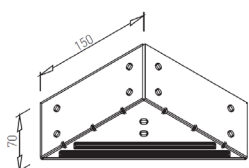
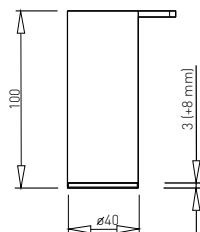
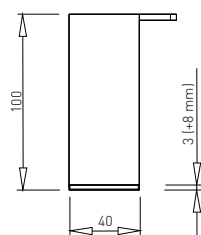

## CUBIC 40 x 40

Obj. číslo:	Rozmer:	Farba:	Výška:
80-30643	40 x 40 mm	RAL 9006G	100 mm

## OPTIC 40

Obj. číslo:	Priemer:	Farba:	Výška:
80-30699	ø 40 mm	RAL 9006G	100 mm

## UHOLNÍK

Obj. číslo:	Rozmer:	Farba:
80-30180	150 x 70 mm	RAL 9006G

## NOHA SILK

Obj. číslo:	Typ:	Farba:	Výška:
80-30903	SILK CUBO 80 (80mm)	RAL 9006G	247 mm
80-30644	SILK CUBO 50 (50 mm)	RAL 9006G	247 mm
80-30183	SILK ø 60 (ø 60 mm)	RAL 9006G	247 mm
80-30121	SILK ø 80 (ø 80 mm)	RAL 9006G	247 mm

NÁBYTKOVÉ NOHY



**NOHA NÁBYTKOVÁ V15B,  
VALEC Ø 30 mm**

Obj. číslo:	Výška:	Materiál:	Farba:
62-3925	100 - 110 mm	ocel	chróm
62-3926	100 - 110 mm	ocel	chróm mat.
62-1535	150 mm	ocel	nikel mat.

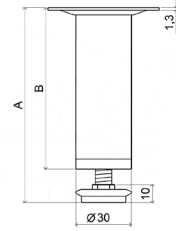
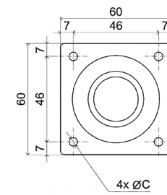

**NOHA NÁBYTKOVÁ V23E0,  
VALEC Ø 32 mm**

Obj. číslo:	Výška:	Materiál:	Farba:
62-2310	100 mm	hliník	strieborná
62-0509	150 mm	hliník	strieborná

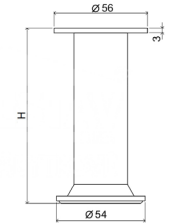
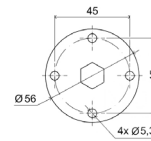

**NOHA NÁBYTKOVÁ VALEC Ø 35 mm**

Obj. číslo:	Výška:	Materiál:	Farba:
17-23151031	100 mm	ocel	hliník



**NOHA NÁBYTKOVÁ V23E5,  
VALEC Ø 50 mm**

Obj. číslo:	Výška:	Materiál:	Farba:
62-5109	100 mm	hliník	strieborná
62-5159	150 mm	hliník	strieborná

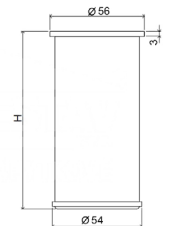
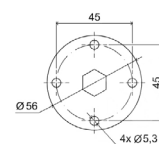

**NOHA NÁBYTKOVÁ V25E, 40 / 40 mm**

Obj. číslo:	Výška:	Materiál:	Farba:
62-1019	96 - 120 mm	plast / hliník	čierna / nerez
62-5509	150 - 170 mm	plast / hliník	čierna / strieborná

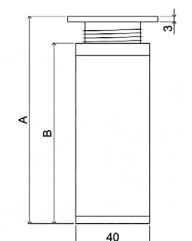
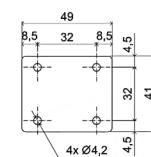

## NÁBYTKOVÉ NOHY

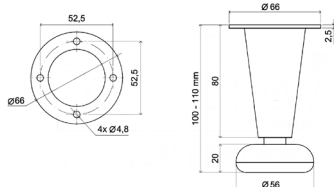
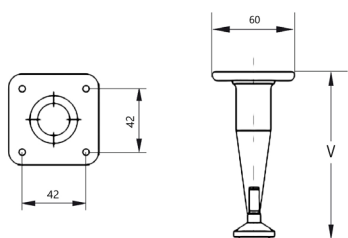
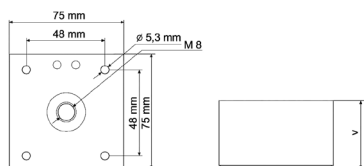
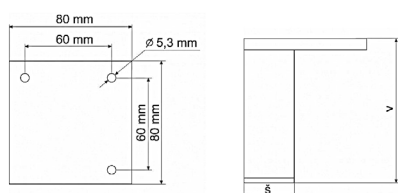

## NOHA NÁBYTKOVÁ, 45 / 45 mm

Obj. číslo:	Výška:	Materiál:	Farba:
62-2018	80 mm	hliník	sivá
62-2017	100 mm	hliník	sivá
62-2019	120 mm	hliník	sivá
62-2016	160 mm	hliník	sivá
62-0200	200 mm	hliník	sivá

## NOHA NÁBYTKOVÁ, 62 / 62 mm

Obj. číslo:	Výška:	Materiál:	Farba:
71-63401900	125 mm	plast	strieborná

## NOHA NÁBYTKOVÁ, 65 / 65 mm

Obj. číslo:	Výška:	Materiál:	Farba:
17-23159029	50 mm	ocel	chróm
17-23159129	100 mm	ocel	chróm
17-23159229	150 mm	ocel	chróm

## NOHA NÁBYTKOVÁ P06, 75 / 75 mm

Obj. číslo:	Výška:	Materiál:	Farba:
62-2220	20 mm	plast	sivá / hliník
62-0630	30 mm	plast	sivá / hliník
62-2020	50 mm	plast	sivá / hliník
62-2120	60 mm	plast	sivá / hliník

## NOHA NÁBYTKOVÁ, KÓNICKÁ

Obj. číslo:	Základňa:	Výška:	Materiál:	Farba:
62-0925	60 / 60 mm	100 mm	zliatina	chóm

## NOHA NÁBYTKOVÁ V21E, KÓNICKÁ

Spodná časť nôžky je opatrená svetlou plastovou podložkou

Obj. číslo:	Základňa:	Výška:	Materiál:	Farba:
62-2295	ø 70 / 60 mm	100 - 110 mm	zliatina	nikel mat.
62-2195	ø 70 / 60 mm	100 - 110 mm	zliatina	chóm

## KLZÁKY A KOLIESKA

### KLZÁK REKTIFIKAČNÝ

Obj. číslo:	Priemer D:	Výška:	Nosnosť:	
62-2049	17 mm	17 - 25,5 mm	-	1
62-2249	22 mm	30 - 40 mm	-	1
62-2150	22 mm	20 - 27 mm	-	2
62-0515	25 mm	-	-	6
62-0506	28 mm	22 - 30 mm	-	2
62-2449	48 mm	42 - 68 mm	-	5
62-3052	49 mm	44 - 60 mm	100 kg	4
62-2051	49 mm	17 - 33 mm	80 kg	4
62-2050	49 mm	27 - 43 mm	100 kg	4
62-0921	50 mm	27 - 38 mm	50 kg	4
62-2552	50 mm	17 - 28 mm	50 kg	3

### KLZÁK ZÁVRTNÝ SKRUTKOVACÍ

Obj. číslo:	Priemer D:	Výška:
71-63705001	20 mm	6,7- 51,7 mm

### KLZÁK SKRUTKOVACÍ

Obj. číslo:	Priemer D:	Výška:
71-65102909	30 mm	16 - 35 mm

### KLZÁK SKRUTKOVACÍ, PLAST

Obj. číslo:	Rozmer:	Výška:	Farba:
13-0320	50 x 14 mm	5 mm	hnedá
13-0317	50 x 14 mm	5 mm	biela

### KLZÁK NASTREĽOVACÍ, PLAST

Obj. číslo:	Rozmer:	Výška:	Farba:
13-0318	36 x 15 mm	5 mm	čierna
13-0329	36 x 15 mm	5 mm	sv. hnedá
13-0322	36 x 15 mm	5 mm	hnedá
13-0225	60 x 60 x 90 mm	5 mm	hnedá
13-0227	60 x 60 x 90 mm	5 mm	čierna

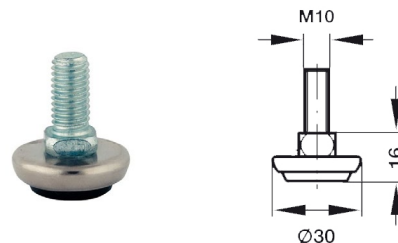
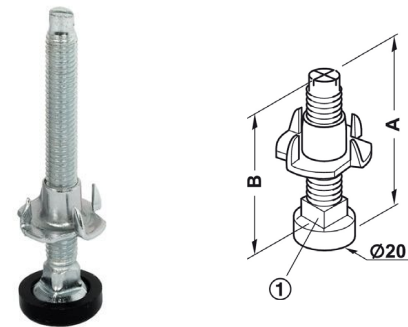

## KLZÁKY A KOLIESKA

## KOLIESKA

Obj. číslo:	Priemer kolieska D:	Výška:	Nosnosť:	Brzda:	
71-66123322	25 mm	18 mm	15 kg	nie	2
71-66123304	25 mm	28 mm	20 kg	nie	2
13-0147	25 mm	28 mm	-	nie	3
62-900920	25 mm	34 mm	10 kg	nie	4
62-230549	27 mm	29 mm	20 kg	nie	5
62-900931	30 mm	35 mm	20 kg	nie	6
13-0144	30 mm	33 mm	25 kg	nie	3
62-900921	30 mm	37 mm	15 kg	nie	4
62-0452	35 mm	52 mm	25 kg	nie	7
62-0453	35 mm	52 mm	25 kg	áno	8
71-66098904	35 mm	41 mm	40 kg	nie	12
71-66007301	35 mm	48 mm	25 kg	nie	1
24-06101040	40 mm	-	-	nie	1
62-224099	40 mm	59 mm	35 kg	nie	17
71-66007311	40 mm	54 mm	35 kg	nie	1
62-900922	40 mm	54 mm	20 kg	nie	4
71-66007314	40 mm	50 mm	35 kg	nie	11
62-224098	40 mm	59 mm	35 kg	áno	14
62-4204	40 mm	55 mm	25 kg	nie	13
24-06101050	50 mm	-	-	nie	1
62-900927	50 mm	65 mm	35 kg	nie	10
62-900923	50 mm	65 mm	35 kg	nie	9
62-220530	50 mm	64 mm	35 kg	nie	-
62-224110	50 mm	64 mm	35 kg	nie	15
62-220540	50 mm	70 mm	55 kg	nie	16
62-220026	50 mm	68 mm	70 kg	áno	21
71-66007324	50 mm	60 mm	40 kg	nie	11
71-66008321	50 mm	63 mm	40 kg	áno	18
71-66007321	50 mm	63 mm	40 kg	nie	1
71-66018264	50 mm	69 mm	50 kg	nie	19
71-66019261	50 mm	69 mm	50 kg	áno	19
62-2241100	50 mm	64 mm	35 kg	áno	27
62-0450	50 mm	67 mm	35 kg	nie	23
62-0451	50 mm	67 mm	35 kg	áno	22
99-6718	60 mm	81 mm	40 kg	nie	20
62-900924	65 mm	84 mm	40 kg	nie	9
62-900928	65 mm	84 mm	40 kg	nie	10
62-0476	75 mm	92 mm	50 kg	áno	25
62-0475	75 mm	95 mm	50 kg	nie	24
62-900925	75 mm	93 mm	50 kg	nie	9
62-900929	75 mm	93 mm	50 kg	nie	10
80-20677	-	102 mm	-	áno	26



1



5



9



13



17



21



25

## KLZÁKY A KOLIESKA



2



3



4



6



7



8

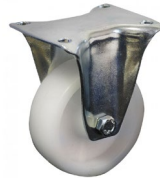

10



11



12



14



15



16



18



19



20



22



23



24



26



27



# POZNÁMKY



A series of horizontal dotted lines for writing notes, organized into 10 sets of three lines each.



# POZNÁMKY

Handwriting practice area consisting of 20 horizontal dotted lines.



# POZNÁMKY



A series of horizontal dotted lines for writing notes, organized into 10 rows. Each row consists of three parallel dotted lines, providing a guide for handwriting.

## TIRÁŽ

twd SK, s.r.o.  
Priemyselná 15278/14  
SK - 974 01 Banská Bystrica

Tel: +421 914 100 000  
Fax: +421 48 / 414 82 17 – 19  
E - mail: info@twd.sk

Právna forma: Spoločnosť s ručením obmedzeným  
Sídlo: Banská Bystrica  
Zapísaná v obchodnom registri SR, vložka číslo 28173/S  
IČO: 48185621  
DIČ: 2120081513  
IČ DPH: SK2120081513  
Číslo bankového účtu: UniCredit Bank  
IBAN: SK18 1111 0000 0013 7237 1018  
SWIFT (BIC): UNCRSKBX

Kontaktia: Ing. Igor Patráš, Andrej Patráš, Igor Patráš

## Vylúčenie ručenia:

Obsahy našich katalógov sa neustále menia. Zakaždým sú zostavované s maximálnou starostlivosťou. Aj napriek tomu nemôžeme prevziať záruku za úplnosť a správnosť textov. Spoločnosť twd SK, s.r.o. neručí za škody vzniknuté na základe používania informácií a údajov uvedených v katalógu, jedine ak by išlo o zámer alebo hrubú nebalosť zo strany spoločnosti twd SK, s.r.o. .

Spoločnosť twd SK, s.r.o. nepreberá ručenie alebo záruku za obsah katalógov.

## Autorské právo / značky:

Všetky obrázky, grafiky, texty a ďalšie informácie, ktoré sú v katalógu zverejnené, ako aj ich stvárnenie podliehajú ochrane autorským právom. Používať tieto chránené obsahy je oprávnená výlučne spoločnosť twd SK, s.r.o. ak nie je uvedené inak. Kopírovanie alebo reprodukovanie je povolené iba s písomným súhlasom spoločnosti twd SK, s.r.o. .

Obzvlášť nie je povolené kopírovať a na vlastné účely používať použité obrázky. Logo spoločnosti twd SK, s.r.o. a slovný výraz twd SK, s.r.o. sú chránenými menami a značkami spoločnosti twd SK, s.r.o.. Okrem toho vlastní spoločnosť twd SK, s.r.o. množstvo ďalších chránených značiek. Používanie značiek spoločnosti twd SK, s.r.o. je povolené iba po predchádzajúcom písomnom súhlase.



# twd®



**twd SK, s.r.o.**

Priemyselná 15278/14, 974 01 Banská Bystrica  
mobil: +421 914 100 000, e-mail: info@twd.sk

**twd SK, s.r.o.**

Kremnička 5, 974 03 Banská Bystrica  
mobil: +421 911 424 069, e-mail: fach02@twd.sk

**twd SK, s.r.o.**

Pri Šajbách 9454/11, 831 06 Bratislava  
mobil: +421 911 424 067, e-mail: bratislava@twd.sk

**twd SK, s.r.o.**

Trenčianska cesta 1667/2A, 957 01 Bánovce n. Bebravou  
mobil: +421 911 424 026, e-mail: banovce@twd.sk

**twd SK, s.r.o.**

Holubyho 12, 040 01 Košice  
mobil: +421 911 424 066, e-mail: kosice@twd.sk

**twd SK, s.r.o. - Showroom**

Puškinova 11, 085 01 Bardejov  
mobil: +421 903 972 267, e-mail: bardejov@twd.sk

**twd CZ, s.r.o.**

Za Drahou 4735, 796 01 Prostějov, Česká republika  
mobil: +420 737 272 922, e-mail: cz@twd.sk

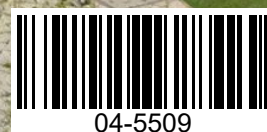

**twd.sk**