

## Pekný pozdrav z twd Vám všetkým!

Držite v rukách ďalšie vydanie twd-katalógu. Nájdete v ňom viac ako tisíc položiek. Pritom sa naďalej môžete spoľahnúť na rozsiahle katalógy našich dodávateľov – producentov kvalitného nábytkového kovania, ktoré sú plné kvalitných riešení pre výrobu nábytku a interiérov. Katalóg je na svete a budeme radi, keď splní svoje poslanie.

Podnikateľské poslanie firmy Trendwood – twd obsahuje aj Príručka kvality systému ISO 9001:2000, ktorou sa riadime v dennom živote:

- byť prospešným článkom pre odberateľov a výrobcov pri odbornej distribúcii tovaru,
- partnerské vzťahy založené na priateľstve – vo vzťahu k odberateľom, dodávateľom a našim partnerom,
- obchodná ponuka založená na kvalite produktov od renomovaných výrobcov,
- svoju činnosť vykonávať odborne, nezávisle, zodpovedne, kvalitne a v plnej miere prispôbovať požiadavkám zákazníka.

Posúdenie, nakoľko sa nám to v dennom živote darí, nechávame na Vás. Často Vám hovoríme, naším cteným zákazníkom, aby ste nám nehovorili v čom sme dobrí, ale radšej to, v čom sa máme zlepšiť. Radi si vypočujeme Váš kritický názor, ktorý zlepší twd-servis smerom k Vám.

Trhové prostredie, v ktorom všetci podnikáme, dáva dlhodobo šancu len producentom kvalitného nábytku s dobrým dizajnom, spoľahlivou konštrukciou a servisom a to všetko v konkurencie schopnej cene. V dynamickom svete nie je pre výrobcu jednoduché naplniť tieto atribúty. Uvedomujeme si, že Váš čas je drahý a preto sa Vám snažíme aj vydaním nového twd-katalógu dať k dispozícii výber najčastejšie používaných nábytkových komponentov, ktorý Vám pomôže ľahšie zostavovať Váš úspešný nábytok a jednoduchšie objednávať potrebný tovar. Katalóg nevyrieši všetko – preto je Vám twd-team stále k dispozícii osobne aj telefonicky, elektronicky, ...

Tešíme sa na stretnutia s Vami a radi prispejeme k Vášmu úspechu.



Ing. Igor Patrás  
riaditeľ firmy



OZNAČENIE VÝROBKOV S VÝHODNOU CENOU



OZNAČENIE VÝROBKOV S VYSOKOU KVALITOU

## twd-ponuka = kvalitné materiály od renomovaných výrobcov



# OBSAH

## NÁBYTKOVÉ KOVANIE

|  |          |
|--|----------|
| <b>1. Závesy nábytkové</b>                     |          |
| 1.1 Závesy s integrovanou brzdou               | 5 - 6    |
| 1.2 Závesy clipové                             | 7 - 10   |
| 1.3 Závesy skrutkovacie                        | 10 - 13  |
| 1.4 Príslušenstvo pre závesy                   | 13 - 15  |
| 1.5 Program uhlových závesov                   | 16 - 17  |
| <b>2. Výsuvy zásuvkové</b>                     |          |
| 2.1 TANDEMBOX                                  | 18 - 22  |
| 2.2 TANDEMBOX INTIVO                           | 22 - 24  |
| 2.3 TANDEMBOX SPACE CORNER                     | 24 - 25  |
| 2.4 príslušenstvo pre TANDEMBOX                | 25 - 29  |
| 2.5 MOVENTO                                    | 30       |
| 2.6 TANDEM                                     | 31 - 32  |
| 2.7 Príslušenstvo pre TANDEM                   | 32       |
| 2.8 METABOX, T-LINEBOX                         | 33 - 35  |
| <b>3. Výklopné dvere</b>                       |          |
| 3.1 Výklopy AVENTOS                            | 36 - 39  |
| 3.2 Výklopy ostatné                            | 39       |
| 3.3 Úchytky                                    | 40 - 45  |
| <b>4. Nohy, podnože a kolieska</b>             |          |
| 4.1 Systém chrbát                              | 46       |
| 4.2 Systém spojka                              | 47 - 48  |
| 4.3 Systém rám                                 | 49       |
| 4.4 Samostatné nohy                            | 50       |
| 4.5 Samostatné podnože                         | 51       |
| 4.6 Samostatné nožičky                         | 52       |
| 4.7 Soklové nožičky                            | 53       |
| 4.8 Nožičky nábytkové                          | 53 - 54  |
| 4.9 Kolieska                                   | 54       |
| 4.10 Klzáky                                    | 55       |
| 4.11 Sokle a soklové tesnenie                  | 55       |
| <b>5. Kovanie na posuvné dvere</b>             |          |
| 5.1 Systém posuvných dverí s dolným vedením    | 56       |
| 5.2 Systém posuvných dverí s horným vedením    | 59       |
| 5.3.   |          |
| 5.4 Systém posuvných dverí na vstavané skrine  | 64 - 73  |
| <b>6. Drôtený program</b>                      |          |
| 6.1 Kuchynské doplnky                          | 74 - 75  |
| 6.2 Výsuvné otočné rohy                        | 76       |
| 6.3 Závesný RELING                             | 77 - 78  |
| <b>7. Zámky</b>                                |          |
| 7.1 Zámky nábytkové                            | 79 - 83  |
| <b>8. Doplnky vstavaných skriň</b>             |          |
| 8.1 Doplnky vstavaných skriň                   | 84 - 85  |
| <b>9. Svetidlá</b>                             |          |
| 9.1 LED reflektory                             | 86       |
| 9.2 Svetidlá, osvetlenie pre bytové zariadenia | 86 - 87  |
| <b>10. Spojovací materiál</b>                  |          |
| 10.1 Spojovací materiál                        | 88 - 91  |
| 10.2 Skrutky                                   | 91 - 92  |
| 10.3 Podperky policové                         | 93       |
| <b>11. Príslušenstvo</b>                       |          |
| 11.1 Roletové systémy                          | 94 - 95  |
| 11.2 Roletové súpravy na mieru                 | 95       |
| 11.3 Technické príslušenstvo nábytku           | 96       |
| 11.4 Konzoly                                   | 97       |
| 11.5 Koše na odpadky                           | 98       |
| 11.6 Ostatné                                   | 99 - 101 |

## STAVEBNÉ KOVANIE

|   |           |
|---|-----------|
| <b>1. Kovanie Siegenia</b>                                      |           |
| 1.1 Okenné kovania  | 104 - 107 |
| 1.2 PSK Portal  | 160 - 111 |
| 1.3 PSK Portal 200Z   | 112 - 115 |
| 1.4 HS Portal 300   | 116 - 123 |
| 1.5 FS Portal   | 124 - 127 |
| <b>2. Kovania na vchodové dvere</b>                             |           |
| 2.1 Zámky na vchodové dvere                                     | 128 - 131 |
| 2.2 Protiplechy na vchodové dvere                               | 132 - 133 |
| 2.3 Závesy na vchodové dvere                                    | 134 - 135 |
| <b>3. Kľučky</b>  |           |
| 3.1 Kľučky na okná  | 136 - 139 |
| 3.2 Kľučky na vchodové dvere                                    | 140 - 141 |
| 3.3 Kľučky na interiérové dvere                                 | 142 - 149 |
| <b>4. Interiérové dvere</b>                                     |           |
| 4.1 Zámky na interiérové dvere                                  | 150 - 151 |
| 4.2 Protiplechy na interiérové dvere                            | 151 - 152 |
| 4.3 Cylindrické vložky mechanické                               | 152 - 154 |
| 4.4 Závesy na interiérové dvere                                 | 155 - 158 |
| 4.5 Posuné systémy na drevené dvere                             | 159       |
| 4.6 Posuné systémy na sklenené dvere                            | 159 - 160 |
| 4.7 Znížené vozíky na drevené dvere                             | 161       |
| 4.8 Znížené vozíky<br>s možnosťou prekrytia naklikávacou lištou | 161       |
| 4.9 Systémy na drevené a sklenené dvere                         | 162       |
| 4.10 Posuvno-parkovacie systémy                                 | 162 - 164 |
| 4.11 Systémy pre súčasný pohyb oboch krídel                     | 164       |
| 4.12 Systémy pre garážové brány                                 | 165 - 167 |
| <b>5. Samozatvárače a panikové kovanie</b>                      |           |
| 5.1 Samozatvárače   | 168 - 171 |
| 5.2 Panikové kovanie  | 172       |
| <b>6. Motorické dverové systémy</b>                             |           |
| 6.1 Automatické systémy   | 173       |
| <b>7. Vetráky</b>   |           |
| 7.1 Vetráky do obytných miestností okenné                       | 174       |
| 7.2 Vetráky do obytných miestností nástenné                     | 175       |
| 7.3 Vetráky do zimných záhrad                                   | 176       |
| <b>8. Okapnice a prahy</b>                                      |           |
| 8.1 odkvapové profily   | 177 - 178 |
| 8.2 odkvapové profily krídlové                                  | 179       |
| 8.3 Prahy do vchodových dverí                                   | 179 - 180 |
| 8.4 Príslušenstvo   | 180 - 181 |
| 8.5 Systémy zimných záhrad                                      | 182       |
| 8.6 Systémy opláštenia okien a vchodových                       | 182       |
| <b>9. Tesnenie</b>  |           |
| 9.1 Tesnenie  | 183 - 185 |
| <b>10. Stavebná chémia</b>                                      |           |
| 10.1 Stavebná chémia  | 186 - 188 |
| <b>11. Terasy, fasády</b>                                       |           |
| 11.1 Terasové podlahy   | 189       |
| 11.2 Akustické obklady  | 190       |
| 11.3 Kompaktné obkladové dosky                                  | 191       |
| <b>ELEKTRONÁRADIE</b>   | 193 - 233 |
| index   | 234 - 237 |

# NÁBYTKOVÉ KOVANIE



My vás vždy podržíme

**twd**<sup>®</sup>



■ **Trendwood-twd**, Kremnička 5, P.O. Box 409  
974 03 **Banská Bystrica**  
tel./fax: 048/414 8217-9, e-mail: info@twd.sk, infolinka: 0914 100 000

■ **Trendwood-twd**, Pri Šajbách 9454  
831 06 **Bratislava**  
tel.: 02/4464 8078, fax: 02/446 480 77, e-mail: blava@twd.sk

■ **Trendwood-twd**, Južná trieda 17  
040 01 **Košice**  
tel.: 055/7287 876, fax.: 055/7287 875, e-mail: kosice@twd.sk

■ **Trendwood-twd**, Trenčianska cesta 1667/2A  
957 01 **Bánovce nad Bebravou**  
tel./fax: 038/760 8470, e-mail: banovce@twd.sk

■ **Trendwood-twd**, Ul. SNP 60  
976 66 **Polomka**  
tel./fax: 048/619 33 50, e-mail: polomka@twd.sk

[www.twd.sk](http://www.twd.sk)

## 1.1 ZÁVESY S INTEGROVANOU BRZDOU

### Clip top blumotion 110°



| Uhol otvorenia | Typ dverí    | Typ     | Obj. číslo |
|----------------|--------------|---------|------------|
| 110°           | Naložené     | 71B3550 | 56-3550    |
| 110°           | Polonaložené | 71B3650 | 56-3650    |
| 110°           | Vložené      | 71B3750 | 56-3750    |



### Záves na slepý uhol



| Uhol otvorenia | Typ dverí | Typ     | Obj. číslo |
|----------------|-----------|---------|------------|
| 95°            | Vložené   | 79B9550 | 56-4282    |



ZÁVES CLIP TOP  
NA SLEPÝ UHOL

záves clip top blumotion na slepý uhol

### Clip top blumotion 110° Miska na zarazenie



| Uhol otvorenia | Typ dverí | Typ     | Obj. číslo |
|----------------|-----------|---------|------------|
| 110°           | Naložené  | 71B3580 | 56-3580    |



záves clip top blumotion miska na zarazenie

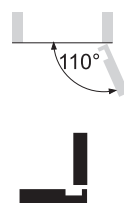

### Clip top blumotion 110° Expando



| Uhol otvorenia | Typ dverí | Typ     | Obj. číslo |
|----------------|-----------|---------|------------|
| 110°           | Naložené  | 71B358E | 56-0652    |



záves clip top blumotion EXPANDO

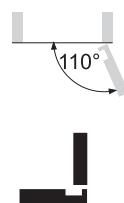

ZÁVESY NÁBYTKOVÉ

# ZÁVESY NÁBYTKOVÉ



záves clip top blumotion INSERTA

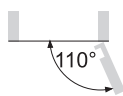

záves clip top blumotion 45°

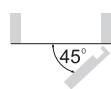

záves clip top blumotion 30°

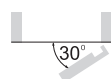

### Clip top blumotion 110° INSERTA

| Uhol otvorenia | Typ dverí    | Typ     | Obj. číslo |
|----------------|--------------|---------|------------|
| 110°           | Naložené     | 71B3590 | 56-3590    |
| 110°           | Polonaložené | 71B3690 | 56-3690    |
| 110°           | Vložené      | 71B3790 | 56-3790    |



### Clip top blumotion 45°

| Uhol otvorenia | Typ dverí    | Typ     | Obj. číslo |
|----------------|--------------|---------|------------|
| 110°           | Naložené     | 79B3558 | 56-1934    |
| 95°            | Naložené     | 79B9458 | 56-0934    |
| 95°            | Polonaložený | 79B9658 | 56-9658    |



### Clip top blumotion 30°

| Uhol otvorenia | Typ dverí | Typ     | Obj. číslo |
|----------------|-----------|---------|------------|
| 95°            | Naložené  | 79B9556 | 56-9556    |

## 1.2 ZÁVESY CLIPOVÉ

Podrobné informácie o nábytkových závesoch CLIP top, CLIP, MODUL a DUO EXPANDO nájdete v špecializovanom katalógu firmy Blum, ktorý vám na vyžiadanie radi zašleme.



### ZÁVES CLIP 100°

| Uhol otvorenia | Typ dverí    | Typ     | Obj. číslo |
|----------------|--------------|---------|------------|
| 100°           | Naložené     | 71M2550 | 56-0001    |
| 100°           | Polonaložené | 71M2650 | 56-0009    |
| 100°           | Vložené      | 71M2750 | 56-0011    |



ZÁVES CLIP 100°



### ZÁVES CLIP TOP 107°

| Uhol otvorenia | Typ dverí    | Typ     | Obj. číslo |
|----------------|--------------|---------|------------|
| 107°           | Naložené     | 75T1550 | 56-0253    |
| 107°           | Polonaložené | 75T1650 | 56-0437    |
| 107°           | Vložené      | 75T1750 | 56-1437    |



ZÁVES CLIP TOP 107°



### ZÁVES CLIP TOP 120°

| Uhol otvorenia | Typ dverí    | Typ     | Obj. číslo   |
|----------------|--------------|---------|--------------|
| 120°           | Naložené     | 71T5550 | 56-0533      |
| 120°           | Polonaložené | 71T5650 | 71-34281502  |
| 120°           | Vložené*     | 71T5650 | 71-34281502* |

\* nutné použiť 9 mm montážnu platničku



ZÁVES CLIP TOP 120°

ZÁVESY NÁBYTKOVÉ

# ZÁVESY NÁBYTKOVÉ



ZÁVES CLIP TOP 155°

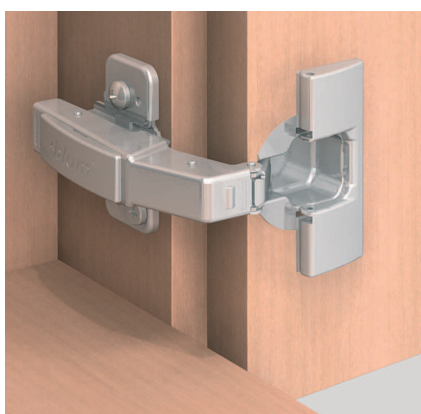
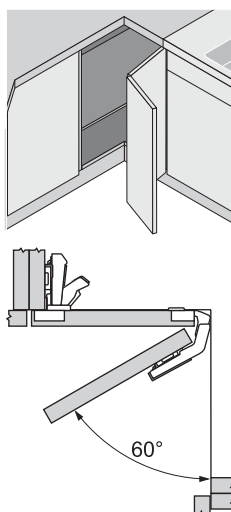

ZÁVES CLIP TOP NA SKLADANÉ DVERE

ZÁVES CLIP TOP  
NA SLEPÝ UHOLZÁVES CLIP TOP  
NA SKLENÉ DVERE

84.4140



84.4120

## ZÁVES CLIP TOP 155°



| Uhol otvorenia | Typ dverí    | Typ      | Obj. číslo |
|----------------|--------------|----------|------------|
| 155°           | Naložené     | 71T7500N | 56-0672    |
| 155°           | Polonaložené | 71T7600N | 56-1672    |
| 155°           | Vložené*     | 71T7600N | 56-1672*   |

\* Nutné použiť 9 mm montážnu platničku

## ZÁVES CLIP TOP NA SKLADANÉ DVERE



| Uhol otvorenia | Dvere    | Typ     | Obj. číslo |
|----------------|----------|---------|------------|
| 60°            | Skladané | 79T8500 | 56-0010*   |

\* Technické riešenie: ☎ twd-dispečing

## ZÁVES CLIP TOP NA SLEPÝ UHOL



| Uhol otvorenia | Typ dverí | Typ     | Obj. číslo |
|----------------|-----------|---------|------------|
| 95°            | Naložené  | 79T9950 | 56-9950*   |
| 95°            | Vložené   | 79T9550 | 56-0385*   |

\* Nutné použiť 3 mm montážnu platničku

## ZÁVES CLIP TOP NA SKLENÉ DVERE



| Uhol otvorenia | Typ dverí    | Typ     | Obj. číslo |
|----------------|--------------|---------|------------|
| 94°            | Naložené     | 75T4100 | 56-0169    |
| 94°            | Polonaložené | 75T4200 | 56-0182    |
| 94°            | Vložené      | 75T4300 | 56-0236    |

## KRYTKY K ZÁVESU CLIP TOP NA SKLENÉ DVERE

| Typ     | Povrchová úprava | Obj. číslo |
|---------|------------------|------------|
| 84.4140 | Čierna           | 56-0147    |
| 84.4140 | Chróm            | 56-0172    |
| 84.4140 | Matný nikel      | 56-0269    |
| 84.4140 | Zlatá            | 56-0222    |
| 84.4120 | Čierna           | 56-0043    |
| 84.4120 | Zlatá            | 56-0159    |
| 84.4120 | Chróm            | 56-0026    |
| 84.4120 | Bronz            | 56-0299    |
| 84.4120 | Matný nikel      | 56-0296    |



**ZÁVES CRISTALLO NA SKLENÉ DVERE**



| Uhol otvorenia | Typ dverí    | Typ     | Obj. číslo |
|----------------|--------------|---------|------------|
| 125°           | Naložené     | 79C4500 | 56-0238    |
| 125°           | Polonaložené | 79C4500 | 56-0238*   |
| 125°           | Vložené      | 79C4500 | 56-0238*   |

\* Technické riešenie: ☎ twd-dispečing

**MISKA CRISTALLO**



| Dvere so sklom  | Typ     | Obj. číslo |
|-----------------|---------|------------|
| Matné sklo      | 78C4568 | 56-0237    |
| Priehľadné sklo | 78C4568 | 56-1237    |

**ZÁVES CLIP TOP NA HLINÍKOVÝ RÁMIK**



| Uhol otvorenia | Typ dverí    | Typ     | Obj. číslo |
|----------------|--------------|---------|------------|
| 95°            | Naložené     | 71T950A | 56-0200    |
| 95°            | Polonaložené | 71T960A | 56-0607    |
| 95°            | Vložené      | 71T970A | 56-1607    |

**ZÁVES CLIP TOP MINI**



| Uhol otvorenia | Typ dverí    | Typ     | Obj. číslo |
|----------------|--------------|---------|------------|
| 94°            | Naložené     | 71T0550 | 56-0234    |
| 94°            | Polonaložené | 71T0650 | 56-0263    |
| 94°            | Vložené      | 71T0750 | 56-0235    |

**KRYTKY K ZÁVESOM CLIP TOP (NA RAMIENKO)**



| Typ     | Povrchová úprava | Obj. číslo |
|---------|------------------|------------|
| 70.1503 | Nikel            | 56-0530    |
| 90M2503 | Nikel            | 56-0157    |
| 70.1563 | Nikel            | 56-1563    |
| 70.1663 | Nikel            | 56-1663    |

**KRYTKY K ZÁVESOM CLIP TOP (NA MISKU)**



| Typ     | Povrchová úprava | Obj. číslo |
|---------|------------------|------------|
| 70T1504 | Nikel            | 56-0534    |
| 70T3504 | Nikel            | 56-3504    |

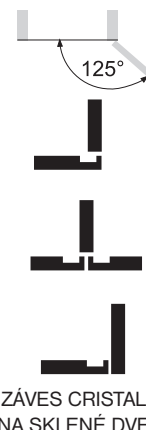

ZÁVES CRISTALLO  
NA SKLENÉ DVERE



ZÁVES CLIP TOP  
NA HLINÍKOVÝ RÁMIK



ZÁVES CLIP TOP MINI

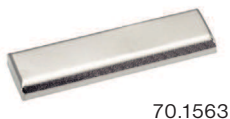
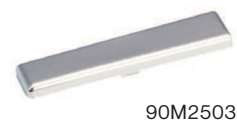

**ZÁVESY NÁBYTKOVÉ**

# ZÁVESY NÁBYTKOVÉ



173L6100



174E6100

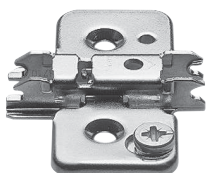

173H7100

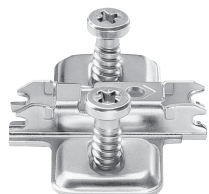

173L8100

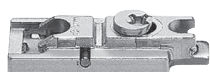

175H5400

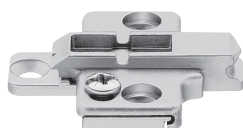

175H7190

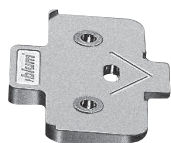

171A5010, 171A5040, 171A5070

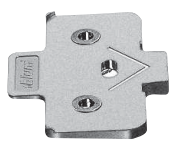

171A5500

## MONTÁŽNE PLATNIČKY NA ZÁVESY CLIP TOP A CLIP



| Typ      | Zvýšenie | Obj. číslo |
|----------|----------|------------|
| 173L6100 | 0 mm     | 56-0002    |

| Typ      | Zvýšenie | Obj. číslo |
|----------|----------|------------|
| 174E6100 | 0 mm     | 56-0479    |
| 174E6130 | 3 mm     | 56-1348    |

| Typ      | Zvýšenie | Obj. číslo |
|----------|----------|------------|
| 173H7100 | 0 mm     | 56-0248    |
| 173H7130 | 3 mm     | 56-0249    |

| Typ      | Zvýšenie | Obj. číslo |
|----------|----------|------------|
| 173L8100 | 0 mm     | 56-0016    |
| 173L8130 | 3 mm     | 56-0506    |

| Typ      | Zvýšenie | Obj. číslo |
|----------|----------|------------|
| 175H5400 | 0 mm     | 56-0229    |

| Typ      | Zvýšenie | Obj. číslo |
|----------|----------|------------|
| 175H7190 | 9 mm     | 56-0304    |

## DIŠŤANČNÉ KLINY

| Typ      | Zvýšenie | Obj. číslo |
|----------|----------|------------|
| 171A5010 | 0 mm     | 56-0266    |
| 171A5040 | 3 mm     | 56-0281    |
| 171A5070 | 6 mm     | 56-0267    |
| 171A5500 | 6 mm     | 56-0268    |

Ostatné typy montážnych platničiek nájdete v špecializovanom katalógu firmy Blum.

## 1.3 ZÁVESY SKRUTKOVACIE

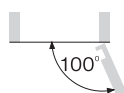

ZÁVES MODUL 100°

### ZÁVES MODUL 100°



| Uhol otvorenia | Typ dverí    | Typ     | Obj. číslo |
|----------------|--------------|---------|------------|
| 100°           | Naložené     | 91M2550 | 56-0306    |
| 100°           | Polonaložené | 91M2650 | 56-0023    |
| 100°           | Vložené      | 91M2750 | 56-0034    |



ZÁVES METALLAMAT 110°

### ZÁVES METALLAMAT 110°



| Uhol otvorenia | Typ dverí    | Obj. číslo  |
|----------------|--------------|-------------|
| 110°           | Naložené     | 71-31190500 |
| 110°           | Polonaložené | 71-31190501 |
| 110°           | Vložené      | 71-31190502 |

**ZÁVES T-LINE S MONTÁŽNOU PLATNIČKOU 110°**

PRIAZNIVÁ  
CENA 1

| Uhol otvorenia | Typ dverí    | Obj. číslo  |
|----------------|--------------|-------------|
| 110°           | Naložené     | 24-01119022 |
| 110°           | Polonaložené | 24-01119042 |
| 110°           | Vložené      | 24-01119082 |

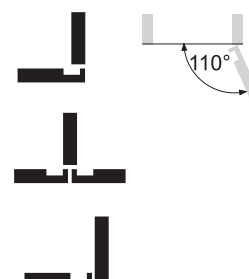
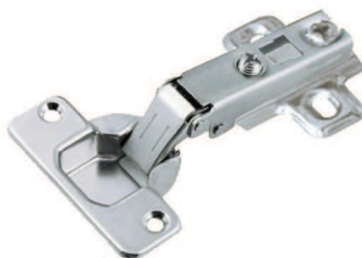

ZÁVES T-LINE 110°

TOP  
KVALITA

**ZÁVES MODUL EXPANDO 100°  
S PREDMONTOVANOU MONTÁŽNOU PLATNIČKOU**

| Uhol otvorenia | Typ dverí    | Typ        | Obj. číslo |
|----------------|--------------|------------|------------|
| 100°           | Naložené     | 91M258E.E0 | 56-0333    |
| 100°           | Polonaložené | 91M268E.E0 | 56-0406    |
| 100°           | Vložené      | 91M278E.E0 | 56-1333    |

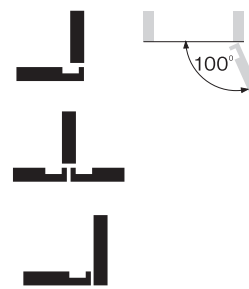
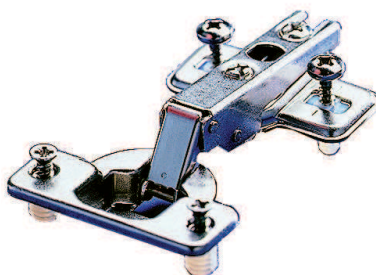

ZÁVES EXPANDO 100°

**ZÁVES MODUL 170°**

TOP  
KVALITA

| Uhol otvorenia | Typ dverí    | Typ     | Obj. číslo |
|----------------|--------------|---------|------------|
| 170°           | Naložené     | 91A6550 | 56-0036    |
| 170°           | Polonaložené | 91A6650 | 56-0377    |
| 170°           | Vložené      | 91A6650 | 56-0377*   |

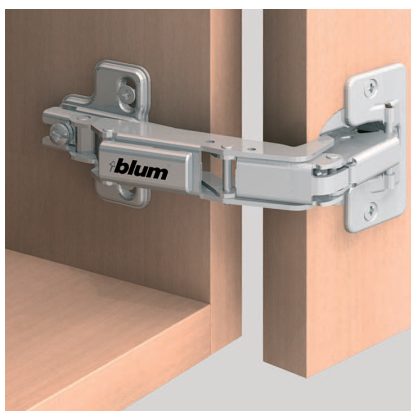

ZÁVES MODUL 170°

\* Nutné použiť 9 mm montážnu platničku

**ZÁVES METALLAMAT 175°**

PRIAZNIVÁ  
CENA 1

| Uhol otvorenia | Typ dverí    | Obj. číslo   |
|----------------|--------------|--------------|
| 175°           | Naložené     | 71-31632600  |
| 175°           | Polonaložené | 71-31632601  |
| 175°           | Vložené      | 71-31632601* |

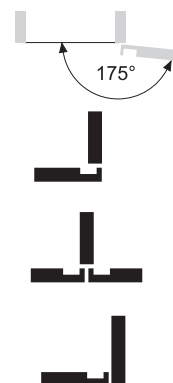

ZÁVES METALLAMAT 175°

\* Technické riešenie: ☎ twd-dispečing

**ZÁVES MODUL UHLOVÝ 45°**

TOP  
KVALITA

| Uhol otvorenia | Typ dverí    | Typ     | Obj. číslo |
|----------------|--------------|---------|------------|
| 107°           | Naložené     | 99M1550 | 56-0038    |
| 107°           | Polonaložené | 99M1550 | 56-0038*   |
| 107°           | Vložené      | 99M1550 | 56-0038**  |

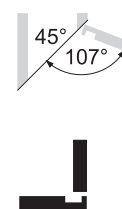

ZÁVES MODUL  
UHLOVÝ 45°

\* Nutné použiť 3 mm montážnu platničku

\*\*Nutné použiť 18 mm montážnu platničku

ZÁVESY NÁBYTKOVÉ

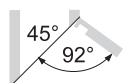
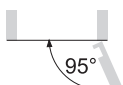
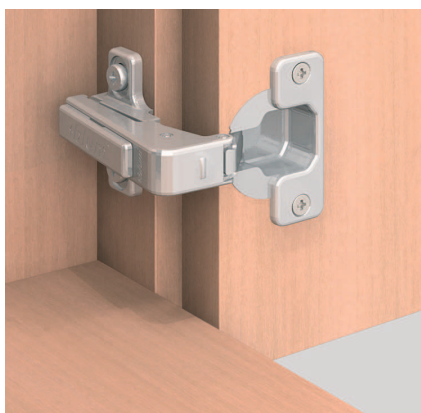
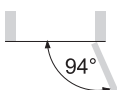
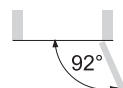
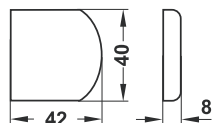
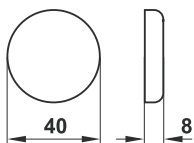
**ZÁVES METALLAMAT  
UHLOVÝ 45°**

**ZÁVES MODUL  
NA SLEPÝ UHOL**

**ZÁVES MODUL  
NA CHLADNIČKOVÉ DVERE**

**ZÁVES METALLAMAT  
NA SKLENÉ DVERE**

**ZÁVES METALLAMAT UHLOVÝ 45°**
**PRIAZNIVÁ  
CENA 1**

| Uhol otvorenia | Typ dverí    | Obj. číslo  |
|----------------|--------------|-------------|
| 92°            | Naložené     | 71-31634501 |
| 92°            | Polonaložené | 71-31634501 |
| 92°            | Vložené      | 71-31634501 |

**ZÁVES MODUL NA SLEPÝ UHOL**
**TOP  
KVALITA**

| Uhol otvorenia | Typ dverí | Typ     | Obj. číslo |
|----------------|-----------|---------|------------|
| 95°            | Vložené   | 99M9550 | 56-0012    |

**MONTÁŽNA PLATNIČKA NA SLEPÝ UHOL**

| Typ      | Obj. číslo |
|----------|------------|
| 199.8130 | 56-0173    |

**ZÁVES MODUL NA CHLADNIČKOVÉ DVERE**
**TOP  
KVALITA**

| Uhol otvorenia | Typ dverí | Typ     | Obj. číslo |
|----------------|-----------|---------|------------|
| 94°            | Naložené  | 91K9550 | 56-2533    |

**ZÁVES METALLAMAT NA SKLENÉ DVERE**
**PRIAZNIVÁ  
CENA 1**

| Uhol otvorenia | Typ dverí    | Obj. číslo  |
|----------------|--------------|-------------|
| 92°            | Naložené     | 71-31633300 |
| 92°            | Polonaložené | 71-31633301 |
| 92°            | Vložené      | 71-31633302 |

**KRYTKY K ZÁVESU METALLAMAT NA SKLENÉ DVERE**

| Typ     | Povrchová úprava | Obj. číslo  |
|---------|------------------|-------------|
| Okrúhla | Chróm            | 71-31610420 |
| Okrúhla | Zlatá            | 71-31610520 |
| Okrúhla | Čierna           | 71-31610120 |
| Oválna  | Chróm            | 71-31610410 |
| Oválna  | Zlatá            | 71-31610510 |
| Oválna  | Čierna           | 71-31610110 |

**MONTÁŽNE PLATNIČKY NA ZÁVESY MODUL**



| Typ      | Zvýšenie | Obj. číslo |
|----------|----------|------------|
| 193L6100 | 0 mm     | 56-0035    |
| 193L6130 | 3 mm     | 56-0214    |

| Typ      | Zvýšenie | Obj. číslo |
|----------|----------|------------|
| 194E6100 | 0 mm     | 56-0031    |
| 194E6130 | 3 mm     | 56-0061    |

| Typ      | Zvýšenie | Obj. číslo |
|----------|----------|------------|
| 193L8100 | 0 mm     | 56-0022    |

| Typ      | Zvýšenie | Obj. číslo |
|----------|----------|------------|
| 199.8130 | 3 mm     | 56-0173    |

**MONTÁŽNA PLATNIČKA K ZÁVESU NA CHLADNIČ. DVERE**

| Typ       | Obj. číslo |
|-----------|------------|
| 194K6100E | 56-8728    |



**MONTÁŽNE PLATNIČKY NA ZÁVESY METALLAMAT**

| Povrchová úprava | Zvýšenie | Obj. číslo  |
|------------------|----------|-------------|
| Matný nikel      | 0 mm     | 71-31198500 |
| Matný nikel      | 2 mm     | 71-31651502 |
| Matný nikel      | 4 mm     | 71-31651504 |
| Matný nikel      | 6 mm     | 71-31651506 |
| Matný nikel      | 8 mm     | 71-31651508 |



193L6100

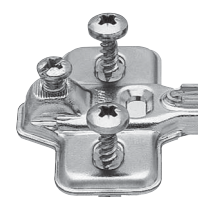

194E6100

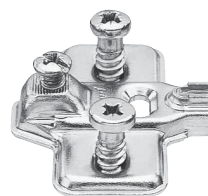

193L8100

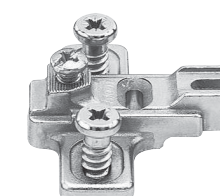

199.8130



71-31198500

**1.4 PRÍSLUŠENSTVO PRE ZÁVESY**

**BLUMOTION NA ZÁVES NALOŽENÝ**



| Typ dverí                                    | Typ      | Obj. číslo |
|--|----------|------------|
| Naložené - 100°, 107°, 120°, hliníkový rámik | 973A0500 | 56-0692    |



973A0500

**BLUMOTION NA ZÁVES POLONALOŽENÝ**



| Typ dverí  | Typ      | Obj. číslo |
|--|----------|------------|
| Polonaložené - 100°, 107°, 120°, hliníkový rámik | 973A0600 | 56-9731    |



973A0600

**BLUMOTION NA ZÁVES VLOŽENÝ**



| Typ dverí                                   | Typ      | Obj. číslo |
|---|----------|------------|
| Vložené - 100°, 107°, 120°, hliníkový rámik | 973A0700 | 56-9730    |



973A0700

**BLUMOTION NA ZÁVES**



| Typ dverí                              | Typ      | Obj. číslo |
|--|----------|------------|
| Naložené, polonaložené, vložené - 155° | 973A7000 | 56-9733    |



973A7000

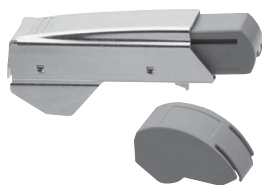

973A7680



971A0200



971A0500



970A1002



970.1002

**BLUMOTION NA UHLOVÝ ZÁVES**

| Typ dverí                  | Typ      | Obj. číslo |
|----------------------------|----------|------------|
| Naložené - +45° (79T55X0X) | 973A7680 | 56-7680    |

**BLUMOTION NA PLOCHU PRIAMY**

| Typ dverí | Typ      | Obj. číslo |
|-----------|----------|------------|
| Naložené  | 971A0200 | 56-9710    |

**BLUMOTION NA PLOCHU KRÍŽOVÝ**

| Typ dverí | Typ      | Obj. číslo |
|-----------|----------|------------|
| Naložené  | 971A0500 | 56-0701    |

**BLUMOTION DO HRANY K ZÁVESU**

| Typ      | Obj. číslo |
|----------|------------|
| 970A1002 | 56-9701    |

**BLUMOTION DO HRANY OPROTI ZÁVESU**

| Typ      | Obj. číslo |
|----------|------------|
| 970.1002 | 56-5002    |



**ADAPTAČNÉ PODLOŽKY K BLUMOTION**

| Typ      | Názov   | Obj. číslo |
|----------|---------|------------|
| 970.1201 | Priamy  | 56-1201    |
| 970.1501 | Križový | 56-1501    |



970.1201



970.1501



**TIP-ON DVEROVÝ „ŠTANDARD“**

| Typ      | Názov         | Obj. číslo |
|----------|---------------|------------|
| 955.1002 | TIP-ON        | 56-0724    |
| 955.1008 | MPL kontaktná | 56-0723    |



955.1002



**TIP-ON DVEROVÝ „PREDLŽENÁ VERZIA“**

| Typ      | Názov         | Obj. číslo |
|----------|---------------|------------|
| 955A1002 | TIP-ON        | 56-0732*   |
| 955.1008 | MPL kontaktná | 56-0723    |

\* Väčšia sila odtlačenia dverí - vhodný pre vložené dvere alebo veľké dvere



955.1008



**TIP-ON ADAPTÉR**

| Typ      | Názov   | Obj. číslo |
|----------|---------|------------|
| 955.1201 | Priamy  | 56-0725    |
| 955.1501 | Križový | 56-0726    |



955.1201



955.1501

|   | CLIP top CRISTALLO   | CLIP top Mini                         | CLIP top Sklenené dvere  |                                       |                                       |                                       |          |          |          |          |   |   |                                       |                                       |                                       |                                       |                                       |           |           |          |          |          |          |          |   |   |                                       |                                       |                                       |                                       |                                       |           |           |          |          |          |          |          |
|---|--|---------------------------------------|--|---------------------------------------|---------------------------------------|---------------------------------------|----------|----------|----------|----------|---|---|---------------------------------------|---------------------------------------|---------------------------------------|---------------------------------------|---------------------------------------|-----------|-----------|----------|----------|----------|----------|----------|---|---|---------------------------------------|---------------------------------------|---------------------------------------|---------------------------------------|---------------------------------------|-----------|-----------|----------|----------|----------|----------|----------|
| -50°  |  |                                       |  |                                       |                                       |                                       |          |          |          |          |   |   |                                       |                                       |                                       |                                       |                                       |           |           |          |          |          |          |          |   |   |                                       |                                       |                                       |                                       |                                       |           |           |          |          |          |          |          |
| -45°  | <p><b>CLIP top s BLUMOTION 970A1002 – pre navrtanie pri závesoch CRISTALLO, Mini a závesoch na sklenené dvere</b></p> <p>Odstup vrtania pri uhlových závesoch</p>  |                                       | <p>BLUMOTION 970A umiestnený na stranu závesov zaručuje perfektný pohyb aj pri uhlových závesoch. Najprv je potrebné zavítať BLUMOTION 970A do stropu korpusu.</p> <p>Správna pozícia je daná vzdialenosťou stredy otvoru od boku (BA). Ak účinok BLUMOTION nie je dostatočný, odporúčame montáž prídavného BLUMOTION 970A do dna.</p> |                                       |                                       |                                       |          |          |          |          |   |   |                                       |                                       |                                       |                                       |                                       |           |           |          |          |          |          |          |   |   |                                       |                                       |                                       |                                       |                                       |           |           |          |          |          |          |          |
| -40°  | <p><b>Program uhlových závesov</b></p>   |                                       |  |                                       |                                       |                                       |          |          |          |          |   |   |                                       |                                       |                                       |                                       |                                       |           |           |          |          |          |          |          |   |   |                                       |                                       |                                       |                                       |                                       |           |           |          |          |          |          |          |
| -35°  | <table border="1"> <tr> <td>A</td> <td></td> </tr> <tr> <td>B</td> <td></td> </tr> <tr> <td>B1</td> <td></td> </tr> <tr> <td>B2</td> <td></td> </tr> <tr> <td>C</td> <td></td> </tr> <tr> <td>D</td> <td></td> </tr> </table>  |                                       |  | A                                     |                                       | B                                     |          | B1       |          | B2       |   | C   |                                       | D                                     |                                       |                                       |                                       |           |           |          |          |          |          |          |   |   |                                       |                                       |                                       |                                       |                                       |           |           |          |          |          |          |          |
| A   |  |                                       |  |                                       |                                       |                                       |          |          |          |          |   |   |                                       |                                       |                                       |                                       |                                       |           |           |          |          |          |          |          |   |   |                                       |                                       |                                       |                                       |                                       |           |           |          |          |          |          |          |
| B   |  |                                       |  |                                       |                                       |                                       |          |          |          |          |   |   |                                       |                                       |                                       |                                       |                                       |           |           |          |          |          |          |          |   |   |                                       |                                       |                                       |                                       |                                       |           |           |          |          |          |          |          |
| B1  |  |                                       |  |                                       |                                       |                                       |          |          |          |          |   |   |                                       |                                       |                                       |                                       |                                       |           |           |          |          |          |          |          |   |   |                                       |                                       |                                       |                                       |                                       |           |           |          |          |          |          |          |
| B2  |  |                                       |  |                                       |                                       |                                       |          |          |          |          |   |   |                                       |                                       |                                       |                                       |                                       |           |           |          |          |          |          |          |   |   |                                       |                                       |                                       |                                       |                                       |           |           |          |          |          |          |          |
| C   |  |                                       |  |                                       |                                       |                                       |          |          |          |          |   |   |                                       |                                       |                                       |                                       |                                       |           |           |          |          |          |          |          |   |   |                                       |                                       |                                       |                                       |                                       |           |           |          |          |          |          |          |
| D   |  |                                       |  |                                       |                                       |                                       |          |          |          |          |   |   |                                       |                                       |                                       |                                       |                                       |           |           |          |          |          |          |          |   |   |                                       |                                       |                                       |                                       |                                       |           |           |          |          |          |          |          |
| -30°  | <table border="1"> <tr> <td>N° 106 37</td> <td>N° 107 37</td> <td>N° 92 48</td> <td>N° 84 48</td> <td>N° 77 37</td> <td>N° 69 48</td> <td>N° 62 37</td> </tr> <tr> <td>B1 78C4568<br/>B2 79C450BT<br/>C 173H7100<br/>D 171A5500</td> <td>B1 78C4568<br/>B2 79C450BT<br/>C 173H7100<br/>D 171A5500</td> <td>B 71T0650<br/>C 173H7100<br/>D 171A5500</td> <td>B 71T0650<br/>C 173H7100<br/>D 171A5500</td> <td>B 71T0550<br/>C 173H7100<br/>D 171A5500</td> <td>B 75T4200<br/>C 173H7100<br/>D 171A5500</td> <td>B 75T4100<br/>C 173H7100<br/>D 171A5500</td> </tr> <tr> <td>N° 103 33</td> <td>N° 100 33</td> <td>N° 93 48</td> <td>N° 85 48</td> <td>N° 78 33</td> <td>N° 70 48</td> <td>N° 63 33</td> </tr> <tr> <td>B1 78C4568<br/>B2 79C450BT<br/>C 173H7100<br/>D 171A5010</td> <td>B1 78C4568<br/>B2 79C450BT<br/>C 173H7100<br/>D 171A5010</td> <td>B 71T0750<br/>C 173H7100<br/>D 171A5040</td> <td>B 71T0650<br/>C 173H7100<br/>D 171A5070</td> <td>B 71T0550<br/>C 173H7100<br/>D 171A5010</td> <td>B 75T4300<br/>C 173H7100<br/>D 171A5010</td> <td>B 75T4100<br/>C 173H7100<br/>D 171A5010</td> </tr> <tr> <td>N° 103 33</td> <td>N° 100 33</td> <td>N° 93 48</td> <td>N° 85 48</td> <td>N° 78 33</td> <td>N° 70 48</td> <td>N° 63 33</td> </tr> </table> |                                       |  | N° 106 37                             | N° 107 37                             | N° 92 48                              | N° 84 48 | N° 77 37 | N° 69 48 | N° 62 37 | B1 78C4568<br>B2 79C450BT<br>C 173H7100<br>D 171A5500 | B1 78C4568<br>B2 79C450BT<br>C 173H7100<br>D 171A5500 | B 71T0650<br>C 173H7100<br>D 171A5500 | B 71T0650<br>C 173H7100<br>D 171A5500 | B 71T0550<br>C 173H7100<br>D 171A5500 | B 75T4200<br>C 173H7100<br>D 171A5500 | B 75T4100<br>C 173H7100<br>D 171A5500 | N° 103 33 | N° 100 33 | N° 93 48 | N° 85 48 | N° 78 33 | N° 70 48 | N° 63 33 | B1 78C4568<br>B2 79C450BT<br>C 173H7100<br>D 171A5010 | B1 78C4568<br>B2 79C450BT<br>C 173H7100<br>D 171A5010 | B 71T0750<br>C 173H7100<br>D 171A5040 | B 71T0650<br>C 173H7100<br>D 171A5070 | B 71T0550<br>C 173H7100<br>D 171A5010 | B 75T4300<br>C 173H7100<br>D 171A5010 | B 75T4100<br>C 173H7100<br>D 171A5010 | N° 103 33 | N° 100 33 | N° 93 48 | N° 85 48 | N° 78 33 | N° 70 48 | N° 63 33 |
| N° 106 37   | N° 107 37  | N° 92 48                              | N° 84 48   | N° 77 37                              | N° 69 48                              | N° 62 37                              |          |          |          |          |   |   |                                       |                                       |                                       |                                       |                                       |           |           |          |          |          |          |          |   |   |                                       |                                       |                                       |                                       |                                       |           |           |          |          |          |          |          |
| B1 78C4568<br>B2 79C450BT<br>C 173H7100<br>D 171A5500 | B1 78C4568<br>B2 79C450BT<br>C 173H7100<br>D 171A5500  | B 71T0650<br>C 173H7100<br>D 171A5500 | B 71T0650<br>C 173H7100<br>D 171A5500  | B 71T0550<br>C 173H7100<br>D 171A5500 | B 75T4200<br>C 173H7100<br>D 171A5500 | B 75T4100<br>C 173H7100<br>D 171A5500 |          |          |          |          |   |   |                                       |                                       |                                       |                                       |                                       |           |           |          |          |          |          |          |   |   |                                       |                                       |                                       |                                       |                                       |           |           |          |          |          |          |          |
| N° 103 33   | N° 100 33  | N° 93 48                              | N° 85 48   | N° 78 33                              | N° 70 48                              | N° 63 33                              |          |          |          |          |   |   |                                       |                                       |                                       |                                       |                                       |           |           |          |          |          |          |          |   |   |                                       |                                       |                                       |                                       |                                       |           |           |          |          |          |          |          |
| B1 78C4568<br>B2 79C450BT<br>C 173H7100<br>D 171A5010 | B1 78C4568<br>B2 79C450BT<br>C 173H7100<br>D 171A5010  | B 71T0750<br>C 173H7100<br>D 171A5040 | B 71T0650<br>C 173H7100<br>D 171A5070  | B 71T0550<br>C 173H7100<br>D 171A5010 | B 75T4300<br>C 173H7100<br>D 171A5010 | B 75T4100<br>C 173H7100<br>D 171A5010 |          |          |          |          |   |   |                                       |                                       |                                       |                                       |                                       |           |           |          |          |          |          |          |   |   |                                       |                                       |                                       |                                       |                                       |           |           |          |          |          |          |          |
| N° 103 33   | N° 100 33  | N° 93 48                              | N° 85 48   | N° 78 33                              | N° 70 48                              | N° 63 33                              |          |          |          |          |   |   |                                       |                                       |                                       |                                       |                                       |           |           |          |          |          |          |          |   |   |                                       |                                       |                                       |                                       |                                       |           |           |          |          |          |          |          |
| -25°  |  |                                       |  |                                       |                                       |                                       |          |          |          |          |   |   |                                       |                                       |                                       |                                       |                                       |           |           |          |          |          |          |          |   |   |                                       |                                       |                                       |                                       |                                       |           |           |          |          |          |          |          |
| -20°  |  |                                       |  |                                       |                                       |                                       |          |          |          |          |   |   |                                       |                                       |                                       |                                       |                                       |           |           |          |          |          |          |          |   |   |                                       |                                       |                                       |                                       |                                       |           |           |          |          |          |          |          |
| -15°  |  |                                       |  |                                       |                                       |                                       |          |          |          |          |   |   |                                       |                                       |                                       |                                       |                                       |           |           |          |          |          |          |          |   |   |                                       |                                       |                                       |                                       |                                       |           |           |          |          |          |          |          |
| -10°  |  |                                       |  |                                       |                                       |                                       |          |          |          |          |   |   |                                       |                                       |                                       |                                       |                                       |           |           |          |          |          |          |          |   |   |                                       |                                       |                                       |                                       |                                       |           |           |          |          |          |          |          |
| -5°   |  |                                       |  |                                       |                                       |                                       |          |          |          |          |   |   |                                       |                                       |                                       |                                       |                                       |           |           |          |          |          |          |          |   |   |                                       |                                       |                                       |                                       |                                       |           |           |          |          |          |          |          |
| +5°   |  |                                       |  |                                       |                                       |                                       |          |          |          |          |   |   |                                       |                                       |                                       |                                       |                                       |           |           |          |          |          |          |          |   |   |                                       |                                       |                                       |                                       |                                       |           |           |          |          |          |          |          |

| CLIP top BLUMOTION CLIP top  |       |      |
|------------------------------|-------|------|
| A . . . . CLIP top BLUMOTION | N° 26 | -50° |
| B . . . . CLIP top           | N° 27 | -45° |
| X . . . . INSERTA = 9        | N° 28 | -40° |
| X . . . . Skrutky = 5        | N° 29 | -35° |
|                              | N° 30 | -30° |
|                              | N° 31 | -25° |
|                              | N° 32 | -20° |
|                              | N° 33 | -15° |
|                              | N° 34 | -10° |
|                              | N° 35 | -5°  |
|                              | N° 16 | +5°  |
|                              | N° 46 |      |
|                              | N° 1  |      |
|                              | N° 36 |      |

1.5 PROGRAM UHLOVÝCH ZÁVESOV

**twd**® dodávateľ kvalitných materiálov na výrobu nábytku, okien a dverí



|             |   |        |                      |        |                      |        |                      |   |           |             |          |    |           |    |           |    |           |   |             |   |          |   |          |   |          |  |        |                      |  |                      |                      |                      |                      |          |                      |           |                      |           |       |           |       |             |      |           |       |          |         |          |         |          |         |          |  |          |                      |          |  |        |                      |        |                      |   |           |   |           |   |             |   |           |  |          |                      |          |                      |          |                      |          |   |        |                      |        |                      |        |                      |        |                      |  |       |   |         |   |         |   |         |   |         |   |         |   |         |   |         |   |         |   |         |   |         |   |          |   |             |   |          |   |          |   |          |             |          |   |          |   |          |   |          |            |          |   |          |   |          |   |          |   |          |             |
|-------------|---|--------|----------------------|--------|----------------------|--------|----------------------|---|-----------|-------------|----------|----|-----------|----|-----------|----|-----------|---|-------------|---|----------|---|----------|---|----------|--|--------|----------------------|--|----------------------|----------------------|----------------------|----------------------|----------|----------------------|-----------|----------------------|-----------|-------|-----------|-------|-------------|------|-----------|-------|----------|---------|----------|---------|----------|---------|----------|--|----------|----------------------|----------|--|--------|----------------------|--------|----------------------|---|-----------|---|-----------|---|-------------|---|-----------|--|----------|----------------------|----------|----------------------|----------|----------------------|----------|---|--------|----------------------|--------|----------------------|--------|----------------------|--------|----------------------|--|-------|---|---------|---|---------|---|---------|---|---------|---|---------|---|---------|---|---------|---|---------|---|---------|---|---------|---|----------|---|-------------|---|----------|---|----------|---|----------|-------------|----------|---|----------|---|----------|---|----------|------------|----------|---|----------|---|----------|---|----------|---|----------|-------------|
| <b>+3°</b>  | <table border="1"> <tr> <td>C<br/>D</td> <td>173H7100<br/>171A5010</td> <td>C<br/>D</td> <td>173H7100<br/>171A5010</td> </tr> <tr> <td></td> <td>N° 103 33</td> <td></td> <td>N° 100 33</td> </tr> <tr> <td>B1</td> <td>78C4568</td> <td>B1</td> <td>78C4568</td> </tr> <tr> <td>B2</td> <td>79C450BT</td> <td>B2</td> <td>79C450BT</td> </tr> <tr> <td>C</td> <td>173H7100</td> <td>C</td> <td>173H7100</td> </tr> <tr> <td>D</td> <td>171A5010</td> <td>D</td> <td>171A5010</td> </tr> </table> | C<br>D | 173H7100<br>171A5010 | C<br>D | 173H7100<br>171A5010 |        | N° 103 33            |   | N° 100 33 | B1          | 78C4568  | B1 | 78C4568   | B2 | 79C450BT  | B2 | 79C450BT  | C | 173H7100    | C | 173H7100 | D | 171A5010 | D   | 171A5010 | <table border="1"> <tr> <td>C<br/>D</td> <td>173H7100<br/>171A5040</td> <td>C<br/>D</td> <td>173H7100<br/>171A5070</td> <td>C<br/>D</td> <td>173H7100<br/>171A5010</td> </tr> <tr> <td></td> <td>N° 93 48</td> <td></td> <td>N° 85 48</td> <td></td> <td>N° 78 33</td> </tr> <tr> <td>B</td> <td>71T0750</td> <td>B</td> <td>71T0650</td> <td>B</td> <td>71T0550</td> </tr> <tr> <td>C</td> <td>173H7100</td> <td>C</td> <td>173H7100</td> <td>C</td> <td>173H7100</td> </tr> <tr> <td>D</td> <td>171A5040</td> <td>D</td> <td>171A5070</td> <td>D</td> <td>171A5010</td> </tr> </table>       | C<br>D | 173H7100<br>171A5040 | C<br>D   | 173H7100<br>171A5070 | C<br>D               | 173H7100<br>171A5010 |                      | N° 93 48 |                      | N° 85 48  |                      | N° 78 33  | B     | 71T0750   | B     | 71T0650     | B    | 71T0550   | C     | 173H7100 | C       | 173H7100 | C       | 173H7100 | D       | 171A5040 | D  | 171A5070 | D                    | 171A5010 | <table border="1"> <tr> <td>C<br/>D</td> <td>173H7100<br/>171A5010</td> <td>C<br/>D</td> <td>173H7100<br/>171A5010</td> </tr> <tr> <td></td> <td>N° 70 48</td> <td></td> <td>N° 63 33</td> </tr> <tr> <td>B</td> <td>75T4300</td> <td>B</td> <td>75T4100</td> </tr> <tr> <td>C</td> <td>173H7100</td> <td>C</td> <td>173H7100</td> </tr> <tr> <td>D</td> <td>171A5010</td> <td>D</td> <td>171A5010</td> </tr> </table>     | C<br>D | 173H7100<br>171A5010 | C<br>D | 173H7100<br>171A5010 |   | N° 70 48  |   | N° 63 33  | B | 75T4300     | B | 75T4100   | C  | 173H7100 | C                    | 173H7100 | D                    | 171A5010 | D                    | 171A5010 | <table border="1"> <tr> <td>C<br/>D</td> <td>173H7100<br/>171A5010</td> <td>C<br/>D</td> <td>173H7100<br/>171A5010</td> <td>C<br/>D</td> <td>173H7100<br/>171A5010</td> <td>C<br/>D</td> <td>173H7100<br/>171A5010</td> </tr> <tr> <td></td> <td>N° 16</td> <td></td> <td>N° 46</td> <td></td> <td>N° 1</td> <td></td> <td>N° 36</td> </tr> <tr> <td>A</td> <td>71B97.0</td> <td>A</td> <td>71B96.0</td> <td>A</td> <td>71B95.0</td> <td>A</td> <td>71B95.0</td> </tr> <tr> <td>B</td> <td>71T97.0</td> <td>B</td> <td>71T96.0</td> <td>B</td> <td>71T95.0</td> <td>B</td> <td>71T95.0</td> </tr> <tr> <td>C</td> <td>173H7100</td> <td>C</td> <td>173H7100</td> <td>C</td> <td>173H7100</td> <td>C</td> <td>173H7100</td> </tr> <tr> <td>D</td> <td>171A5010</td> <td>D</td> <td>171A5070</td> <td>D</td> <td>171A5010</td> <td>D</td> <td>171A5010</td> </tr> </table>  | C<br>D | 173H7100<br>171A5010 | C<br>D | 173H7100<br>171A5010 | C<br>D | 173H7100<br>171A5010 | C<br>D | 173H7100<br>171A5010 |  | N° 16 |   | N° 46   |   | N° 1    |   | N° 36   | A | 71B97.0 | A | 71B96.0 | A | 71B95.0 | A | 71B95.0 | B | 71T97.0 | B | 71T96.0 | B | 71T95.0 | B | 71T95.0  | C | 173H7100    | C | 173H7100 | C | 173H7100 | C | 173H7100 | D           | 171A5010 | D | 171A5070 | D | 171A5010 | D | 171A5010 | <b>+3°</b> |          |   |          |   |          |   |          |   |          |             |
| C<br>D      | 173H7100<br>171A5010  | C<br>D | 173H7100<br>171A5010 |        |                      |        |                      |   |           |             |          |    |           |    |           |    |           |   |             |   |          |   |          |   |          |  |        |                      |  |                      |                      |                      |                      |          |                      |           |                      |           |       |           |       |             |      |           |       |          |         |          |         |          |         |          |  |          |                      |          |  |        |                      |        |                      |   |           |   |           |   |             |   |           |  |          |                      |          |                      |          |                      |          |   |        |                      |        |                      |        |                      |        |                      |  |       |   |         |   |         |   |         |   |         |   |         |   |         |   |         |   |         |   |         |   |         |   |          |   |             |   |          |   |          |   |          |             |          |   |          |   |          |   |          |            |          |   |          |   |          |   |          |   |          |             |
|             | N° 103 33   |        | N° 100 33            |        |                      |        |                      |   |           |             |          |    |           |    |           |    |           |   |             |   |          |   |          |   |          |  |        |                      |  |                      |                      |                      |                      |          |                      |           |                      |           |       |           |       |             |      |           |       |          |         |          |         |          |         |          |  |          |                      |          |  |        |                      |        |                      |   |           |   |           |   |             |   |           |  |          |                      |          |                      |          |                      |          |   |        |                      |        |                      |        |                      |        |                      |  |       |   |         |   |         |   |         |   |         |   |         |   |         |   |         |   |         |   |         |   |         |   |          |   |             |   |          |   |          |   |          |             |          |   |          |   |          |   |          |            |          |   |          |   |          |   |          |   |          |             |
| B1          | 78C4568   | B1     | 78C4568              |        |                      |        |                      |   |           |             |          |    |           |    |           |    |           |   |             |   |          |   |          |   |          |  |        |                      |  |                      |                      |                      |                      |          |                      |           |                      |           |       |           |       |             |      |           |       |          |         |          |         |          |         |          |  |          |                      |          |  |        |                      |        |                      |   |           |   |           |   |             |   |           |  |          |                      |          |                      |          |                      |          |   |        |                      |        |                      |        |                      |        |                      |  |       |   |         |   |         |   |         |   |         |   |         |   |         |   |         |   |         |   |         |   |         |   |          |   |             |   |          |   |          |   |          |             |          |   |          |   |          |   |          |            |          |   |          |   |          |   |          |   |          |             |
| B2          | 79C450BT  | B2     | 79C450BT             |        |                      |        |                      |   |           |             |          |    |           |    |           |    |           |   |             |   |          |   |          |   |          |  |        |                      |  |                      |                      |                      |                      |          |                      |           |                      |           |       |           |       |             |      |           |       |          |         |          |         |          |         |          |  |          |                      |          |  |        |                      |        |                      |   |           |   |           |   |             |   |           |  |          |                      |          |                      |          |                      |          |   |        |                      |        |                      |        |                      |        |                      |  |       |   |         |   |         |   |         |   |         |   |         |   |         |   |         |   |         |   |         |   |         |   |          |   |             |   |          |   |          |   |          |             |          |   |          |   |          |   |          |            |          |   |          |   |          |   |          |   |          |             |
| C           | 173H7100  | C      | 173H7100             |        |                      |        |                      |   |           |             |          |    |           |    |           |    |           |   |             |   |          |   |          |   |          |  |        |                      |  |                      |                      |                      |                      |          |                      |           |                      |           |       |           |       |             |      |           |       |          |         |          |         |          |         |          |  |          |                      |          |  |        |                      |        |                      |   |           |   |           |   |             |   |           |  |          |                      |          |                      |          |                      |          |   |        |                      |        |                      |        |                      |        |                      |  |       |   |         |   |         |   |         |   |         |   |         |   |         |   |         |   |         |   |         |   |         |   |          |   |             |   |          |   |          |   |          |             |          |   |          |   |          |   |          |            |          |   |          |   |          |   |          |   |          |             |
| D           | 171A5010  | D      | 171A5010             |        |                      |        |                      |   |           |             |          |    |           |    |           |    |           |   |             |   |          |   |          |   |          |  |        |                      |  |                      |                      |                      |                      |          |                      |           |                      |           |       |           |       |             |      |           |       |          |         |          |         |          |         |          |  |          |                      |          |  |        |                      |        |                      |   |           |   |           |   |             |   |           |  |          |                      |          |                      |          |                      |          |   |        |                      |        |                      |        |                      |        |                      |  |       |   |         |   |         |   |         |   |         |   |         |   |         |   |         |   |         |   |         |   |         |   |          |   |             |   |          |   |          |   |          |             |          |   |          |   |          |   |          |            |          |   |          |   |          |   |          |   |          |             |
| C<br>D      | 173H7100<br>171A5040  | C<br>D | 173H7100<br>171A5070 | C<br>D | 173H7100<br>171A5010 |        |                      |   |           |             |          |    |           |    |           |    |           |   |             |   |          |   |          |   |          |  |        |                      |  |                      |                      |                      |                      |          |                      |           |                      |           |       |           |       |             |      |           |       |          |         |          |         |          |         |          |  |          |                      |          |  |        |                      |        |                      |   |           |   |           |   |             |   |           |  |          |                      |          |                      |          |                      |          |   |        |                      |        |                      |        |                      |        |                      |  |       |   |         |   |         |   |         |   |         |   |         |   |         |   |         |   |         |   |         |   |         |   |          |   |             |   |          |   |          |   |          |             |          |   |          |   |          |   |          |            |          |   |          |   |          |   |          |   |          |             |
|             | N° 93 48  |        | N° 85 48             |        | N° 78 33             |        |                      |   |           |             |          |    |           |    |           |    |           |   |             |   |          |   |          |   |          |  |        |                      |  |                      |                      |                      |                      |          |                      |           |                      |           |       |           |       |             |      |           |       |          |         |          |         |          |         |          |  |          |                      |          |  |        |                      |        |                      |   |           |   |           |   |             |   |           |  |          |                      |          |                      |          |                      |          |   |        |                      |        |                      |        |                      |        |                      |  |       |   |         |   |         |   |         |   |         |   |         |   |         |   |         |   |         |   |         |   |         |   |          |   |             |   |          |   |          |   |          |             |          |   |          |   |          |   |          |            |          |   |          |   |          |   |          |   |          |             |
| B           | 71T0750   | B      | 71T0650              | B      | 71T0550              |        |                      |   |           |             |          |    |           |    |           |    |           |   |             |   |          |   |          |   |          |  |        |                      |  |                      |                      |                      |                      |          |                      |           |                      |           |       |           |       |             |      |           |       |          |         |          |         |          |         |          |  |          |                      |          |  |        |                      |        |                      |   |           |   |           |   |             |   |           |  |          |                      |          |                      |          |                      |          |   |        |                      |        |                      |        |                      |        |                      |  |       |   |         |   |         |   |         |   |         |   |         |   |         |   |         |   |         |   |         |   |         |   |          |   |             |   |          |   |          |   |          |             |          |   |          |   |          |   |          |            |          |   |          |   |          |   |          |   |          |             |
| C           | 173H7100  | C      | 173H7100             | C      | 173H7100             |        |                      |   |           |             |          |    |           |    |           |    |           |   |             |   |          |   |          |   |          |  |        |                      |  |                      |                      |                      |                      |          |                      |           |                      |           |       |           |       |             |      |           |       |          |         |          |         |          |         |          |  |          |                      |          |  |        |                      |        |                      |   |           |   |           |   |             |   |           |  |          |                      |          |                      |          |                      |          |   |        |                      |        |                      |        |                      |        |                      |  |       |   |         |   |         |   |         |   |         |   |         |   |         |   |         |   |         |   |         |   |         |   |          |   |             |   |          |   |          |   |          |             |          |   |          |   |          |   |          |            |          |   |          |   |          |   |          |   |          |             |
| D           | 171A5040  | D      | 171A5070             | D      | 171A5010             |        |                      |   |           |             |          |    |           |    |           |    |           |   |             |   |          |   |          |   |          |  |        |                      |  |                      |                      |                      |                      |          |                      |           |                      |           |       |           |       |             |      |           |       |          |         |          |         |          |         |          |  |          |                      |          |  |        |                      |        |                      |   |           |   |           |   |             |   |           |  |          |                      |          |                      |          |                      |          |   |        |                      |        |                      |        |                      |        |                      |  |       |   |         |   |         |   |         |   |         |   |         |   |         |   |         |   |         |   |         |   |         |   |          |   |             |   |          |   |          |   |          |             |          |   |          |   |          |   |          |            |          |   |          |   |          |   |          |   |          |             |
| C<br>D      | 173H7100<br>171A5010  | C<br>D | 173H7100<br>171A5010 |        |                      |        |                      |   |           |             |          |    |           |    |           |    |           |   |             |   |          |   |          |   |          |  |        |                      |  |                      |                      |                      |                      |          |                      |           |                      |           |       |           |       |             |      |           |       |          |         |          |         |          |         |          |  |          |                      |          |  |        |                      |        |                      |   |           |   |           |   |             |   |           |  |          |                      |          |                      |          |                      |          |   |        |                      |        |                      |        |                      |        |                      |  |       |   |         |   |         |   |         |   |         |   |         |   |         |   |         |   |         |   |         |   |         |   |          |   |             |   |          |   |          |   |          |             |          |   |          |   |          |   |          |            |          |   |          |   |          |   |          |   |          |             |
|             | N° 70 48  |        | N° 63 33             |        |                      |        |                      |   |           |             |          |    |           |    |           |    |           |   |             |   |          |   |          |   |          |  |        |                      |  |                      |                      |                      |                      |          |                      |           |                      |           |       |           |       |             |      |           |       |          |         |          |         |          |         |          |  |          |                      |          |  |        |                      |        |                      |   |           |   |           |   |             |   |           |  |          |                      |          |                      |          |                      |          |   |        |                      |        |                      |        |                      |        |                      |  |       |   |         |   |         |   |         |   |         |   |         |   |         |   |         |   |         |   |         |   |         |   |          |   |             |   |          |   |          |   |          |             |          |   |          |   |          |   |          |            |          |   |          |   |          |   |          |   |          |             |
| B           | 75T4300   | B      | 75T4100              |        |                      |        |                      |   |           |             |          |    |           |    |           |    |           |   |             |   |          |   |          |   |          |  |        |                      |  |                      |                      |                      |                      |          |                      |           |                      |           |       |           |       |             |      |           |       |          |         |          |         |          |         |          |  |          |                      |          |  |        |                      |        |                      |   |           |   |           |   |             |   |           |  |          |                      |          |                      |          |                      |          |   |        |                      |        |                      |        |                      |        |                      |  |       |   |         |   |         |   |         |   |         |   |         |   |         |   |         |   |         |   |         |   |         |   |          |   |             |   |          |   |          |   |          |             |          |   |          |   |          |   |          |            |          |   |          |   |          |   |          |   |          |             |
| C           | 173H7100  | C      | 173H7100             |        |                      |        |                      |   |           |             |          |    |           |    |           |    |           |   |             |   |          |   |          |   |          |  |        |                      |  |                      |                      |                      |                      |          |                      |           |                      |           |       |           |       |             |      |           |       |          |         |          |         |          |         |          |  |          |                      |          |  |        |                      |        |                      |   |           |   |           |   |             |   |           |  |          |                      |          |                      |          |                      |          |   |        |                      |        |                      |        |                      |        |                      |  |       |   |         |   |         |   |         |   |         |   |         |   |         |   |         |   |         |   |         |   |         |   |          |   |             |   |          |   |          |   |          |             |          |   |          |   |          |   |          |            |          |   |          |   |          |   |          |   |          |             |
| D           | 171A5010  | D      | 171A5010             |        |                      |        |                      |   |           |             |          |    |           |    |           |    |           |   |             |   |          |   |          |   |          |  |        |                      |  |                      |                      |                      |                      |          |                      |           |                      |           |       |           |       |             |      |           |       |          |         |          |         |          |         |          |  |          |                      |          |  |        |                      |        |                      |   |           |   |           |   |             |   |           |  |          |                      |          |                      |          |                      |          |   |        |                      |        |                      |        |                      |        |                      |  |       |   |         |   |         |   |         |   |         |   |         |   |         |   |         |   |         |   |         |   |         |   |          |   |             |   |          |   |          |   |          |             |          |   |          |   |          |   |          |            |          |   |          |   |          |   |          |   |          |             |
| C<br>D      | 173H7100<br>171A5010  | C<br>D | 173H7100<br>171A5010 | C<br>D | 173H7100<br>171A5010 | C<br>D | 173H7100<br>171A5010 |   |           |             |          |    |           |    |           |    |           |   |             |   |          |   |          |   |          |  |        |                      |  |                      |                      |                      |                      |          |                      |           |                      |           |       |           |       |             |      |           |       |          |         |          |         |          |         |          |  |          |                      |          |  |        |                      |        |                      |   |           |   |           |   |             |   |           |  |          |                      |          |                      |          |                      |          |   |        |                      |        |                      |        |                      |        |                      |  |       |   |         |   |         |   |         |   |         |   |         |   |         |   |         |   |         |   |         |   |         |   |          |   |             |   |          |   |          |   |          |             |          |   |          |   |          |   |          |            |          |   |          |   |          |   |          |   |          |             |
|             | N° 16   |        | N° 46                |        | N° 1                 |        | N° 36                |   |           |             |          |    |           |    |           |    |           |   |             |   |          |   |          |   |          |  |        |                      |  |                      |                      |                      |                      |          |                      |           |                      |           |       |           |       |             |      |           |       |          |         |          |         |          |         |          |  |          |                      |          |  |        |                      |        |                      |   |           |   |           |   |             |   |           |  |          |                      |          |                      |          |                      |          |   |        |                      |        |                      |        |                      |        |                      |  |       |   |         |   |         |   |         |   |         |   |         |   |         |   |         |   |         |   |         |   |         |   |          |   |             |   |          |   |          |   |          |             |          |   |          |   |          |   |          |            |          |   |          |   |          |   |          |   |          |             |
| A           | 71B97.0   | A      | 71B96.0              | A      | 71B95.0              | A      | 71B95.0              |   |           |             |          |    |           |    |           |    |           |   |             |   |          |   |          |   |          |  |        |                      |  |                      |                      |                      |                      |          |                      |           |                      |           |       |           |       |             |      |           |       |          |         |          |         |          |         |          |  |          |                      |          |  |        |                      |        |                      |   |           |   |           |   |             |   |           |  |          |                      |          |                      |          |                      |          |   |        |                      |        |                      |        |                      |        |                      |  |       |   |         |   |         |   |         |   |         |   |         |   |         |   |         |   |         |   |         |   |         |   |          |   |             |   |          |   |          |   |          |             |          |   |          |   |          |   |          |            |          |   |          |   |          |   |          |   |          |             |
| B           | 71T97.0   | B      | 71T96.0              | B      | 71T95.0              | B      | 71T95.0              |   |           |             |          |    |           |    |           |    |           |   |             |   |          |   |          |   |          |  |        |                      |  |                      |                      |                      |                      |          |                      |           |                      |           |       |           |       |             |      |           |       |          |         |          |         |          |         |          |  |          |                      |          |  |        |                      |        |                      |   |           |   |           |   |             |   |           |  |          |                      |          |                      |          |                      |          |   |        |                      |        |                      |        |                      |        |                      |  |       |   |         |   |         |   |         |   |         |   |         |   |         |   |         |   |         |   |         |   |         |   |          |   |             |   |          |   |          |   |          |             |          |   |          |   |          |   |          |            |          |   |          |   |          |   |          |   |          |             |
| C           | 173H7100  | C      | 173H7100             | C      | 173H7100             | C      | 173H7100             |   |           |             |          |    |           |    |           |    |           |   |             |   |          |   |          |   |          |  |        |                      |  |                      |                      |                      |                      |          |                      |           |                      |           |       |           |       |             |      |           |       |          |         |          |         |          |         |          |  |          |                      |          |  |        |                      |        |                      |   |           |   |           |   |             |   |           |  |          |                      |          |                      |          |                      |          |   |        |                      |        |                      |        |                      |        |                      |  |       |   |         |   |         |   |         |   |         |   |         |   |         |   |         |   |         |   |         |   |         |   |          |   |             |   |          |   |          |   |          |             |          |   |          |   |          |   |          |            |          |   |          |   |          |   |          |   |          |             |
| D           | 171A5010  | D      | 171A5070             | D      | 171A5010             | D      | 171A5010             |   |           |             |          |    |           |    |           |    |           |   |             |   |          |   |          |   |          |  |        |                      |  |                      |                      |                      |                      |          |                      |           |                      |           |       |           |       |             |      |           |       |          |         |          |         |          |         |          |  |          |                      |          |  |        |                      |        |                      |   |           |   |           |   |             |   |           |  |          |                      |          |                      |          |                      |          |   |        |                      |        |                      |        |                      |        |                      |  |       |   |         |   |         |   |         |   |         |   |         |   |         |   |         |   |         |   |         |   |         |   |          |   |             |   |          |   |          |   |          |             |          |   |          |   |          |   |          |            |          |   |          |   |          |   |          |   |          |             |
| <b>+5°</b>  | <table border="1"> <tr> <td>C<br/>D</td> <td>173H7100<br/>171A5010</td> <td>C<br/>D</td> <td>173H7100<br/>171A5010</td> </tr> <tr> <td></td> <td>N° 104 33</td> <td></td> <td>N° 101 33</td> </tr> <tr> <td>B1</td> <td>78C4568</td> <td>B1</td> <td>78C4568</td> </tr> <tr> <td>B2</td> <td>79C450BT</td> <td>B2</td> <td>79C450BT</td> </tr> <tr> <td>C</td> <td>173H7100</td> <td>C</td> <td>173H7100</td> </tr> <tr> <td>D</td> <td>171A5010</td> <td>D</td> <td>171A5010</td> </tr> </table> | C<br>D | 173H7100<br>171A5010 | C<br>D | 173H7100<br>171A5010 |        | N° 104 33            |   | N° 101 33 | B1          | 78C4568  | B1 | 78C4568   | B2 | 79C450BT  | B2 | 79C450BT  | C | 173H7100    | C | 173H7100 | D | 171A5010 | D   | 171A5010 |  |        |                      | <table border="1"> <tr> <td>C<br/>D</td> <td>173H7100<br/>171A5010</td> <td>C<br/>D</td> <td>173H7100<br/>171A5010</td> <td>C<br/>D</td> <td>173H7100<br/>171A5010</td> <td>C<br/>D</td> <td>173H7100<br/>171A5010</td> </tr> <tr> <td></td> <td>N° 17</td> <td></td> <td>N° 47</td> <td></td> <td>N° 2</td> <td></td> <td>N° 37</td> </tr> <tr> <td>A</td> <td>79B94.4</td> <td>A</td> <td>79B94.4</td> <td>A</td> <td>79B94.4</td> <td>A</td> <td>79B94.4</td> </tr> <tr> <td>B</td> <td>79A94.4</td> <td>B</td> <td>79A94.4</td> <td>B</td> <td>79A94.4</td> <td>B</td> <td>79A94.4</td> </tr> <tr> <td>C</td> <td>173H7100</td> <td>C</td> <td>173H7100</td> <td>C</td> <td>173H7100</td> <td>C</td> <td>173H7100</td> </tr> <tr> <td>D</td> <td>171A5010</td> <td>D</td> <td>171A5070</td> <td>D</td> <td>171A5010</td> <td>D</td> <td>171A5010</td> </tr> </table> | C<br>D               | 173H7100<br>171A5010 | C<br>D               | 173H7100<br>171A5010 | C<br>D   | 173H7100<br>171A5010 | C<br>D    | 173H7100<br>171A5010 |           | N° 17 |           | N° 47 |             | N° 2 |           | N° 37 | A        | 79B94.4 | A        | 79B94.4 | A        | 79B94.4 | A        | 79B94.4  | B        | 79A94.4              | B        | 79A94.4  | B      | 79A94.4              | B      | 79A94.4              | C | 173H7100  | C | 173H7100  | C | 173H7100    | C | 173H7100  | D  | 171A5010 | D                    | 171A5070 | D                    | 171A5010 | D                    | 171A5010 | <b>+5°</b>  |        |                      |        |                      |        |                      |        |                      |  |       |   |         |   |         |   |         |   |         |   |         |   |         |   |         |   |         |   |         |   |         |   |          |   |             |   |          |   |          |   |          |             |          |   |          |   |          |   |          |            |          |   |          |   |          |   |          |   |          |             |
| C<br>D      | 173H7100<br>171A5010  | C<br>D | 173H7100<br>171A5010 |        |                      |        |                      |   |           |             |          |    |           |    |           |    |           |   |             |   |          |   |          |   |          |  |        |                      |  |                      |                      |                      |                      |          |                      |           |                      |           |       |           |       |             |      |           |       |          |         |          |         |          |         |          |  |          |                      |          |  |        |                      |        |                      |   |           |   |           |   |             |   |           |  |          |                      |          |                      |          |                      |          |   |        |                      |        |                      |        |                      |        |                      |  |       |   |         |   |         |   |         |   |         |   |         |   |         |   |         |   |         |   |         |   |         |   |          |   |             |   |          |   |          |   |          |             |          |   |          |   |          |   |          |            |          |   |          |   |          |   |          |   |          |             |
|             | N° 104 33   |        | N° 101 33            |        |                      |        |                      |   |           |             |          |    |           |    |           |    |           |   |             |   |          |   |          |   |          |  |        |                      |  |                      |                      |                      |                      |          |                      |           |                      |           |       |           |       |             |      |           |       |          |         |          |         |          |         |          |  |          |                      |          |  |        |                      |        |                      |   |           |   |           |   |             |   |           |  |          |                      |          |                      |          |                      |          |   |        |                      |        |                      |        |                      |        |                      |  |       |   |         |   |         |   |         |   |         |   |         |   |         |   |         |   |         |   |         |   |         |   |          |   |             |   |          |   |          |   |          |             |          |   |          |   |          |   |          |            |          |   |          |   |          |   |          |   |          |             |
| B1          | 78C4568   | B1     | 78C4568              |        |                      |        |                      |   |           |             |          |    |           |    |           |    |           |   |             |   |          |   |          |   |          |  |        |                      |  |                      |                      |                      |                      |          |                      |           |                      |           |       |           |       |             |      |           |       |          |         |          |         |          |         |          |  |          |                      |          |  |        |                      |        |                      |   |           |   |           |   |             |   |           |  |          |                      |          |                      |          |                      |          |   |        |                      |        |                      |        |                      |        |                      |  |       |   |         |   |         |   |         |   |         |   |         |   |         |   |         |   |         |   |         |   |         |   |          |   |             |   |          |   |          |   |          |             |          |   |          |   |          |   |          |            |          |   |          |   |          |   |          |   |          |             |
| B2          | 79C450BT  | B2     | 79C450BT             |        |                      |        |                      |   |           |             |          |    |           |    |           |    |           |   |             |   |          |   |          |   |          |  |        |                      |  |                      |                      |                      |                      |          |                      |           |                      |           |       |           |       |             |      |           |       |          |         |          |         |          |         |          |  |          |                      |          |  |        |                      |        |                      |   |           |   |           |   |             |   |           |  |          |                      |          |                      |          |                      |          |   |        |                      |        |                      |        |                      |        |                      |  |       |   |         |   |         |   |         |   |         |   |         |   |         |   |         |   |         |   |         |   |         |   |          |   |             |   |          |   |          |   |          |             |          |   |          |   |          |   |          |            |          |   |          |   |          |   |          |   |          |             |
| C           | 173H7100  | C      | 173H7100             |        |                      |        |                      |   |           |             |          |    |           |    |           |    |           |   |             |   |          |   |          |   |          |  |        |                      |  |                      |                      |                      |                      |          |                      |           |                      |           |       |           |       |             |      |           |       |          |         |          |         |          |         |          |  |          |                      |          |  |        |                      |        |                      |   |           |   |           |   |             |   |           |  |          |                      |          |                      |          |                      |          |   |        |                      |        |                      |        |                      |        |                      |  |       |   |         |   |         |   |         |   |         |   |         |   |         |   |         |   |         |   |         |   |         |   |          |   |             |   |          |   |          |   |          |             |          |   |          |   |          |   |          |            |          |   |          |   |          |   |          |   |          |             |
| D           | 171A5010  | D      | 171A5010             |        |                      |        |                      |   |           |             |          |    |           |    |           |    |           |   |             |   |          |   |          |   |          |  |        |                      |  |                      |                      |                      |                      |          |                      |           |                      |           |       |           |       |             |      |           |       |          |         |          |         |          |         |          |  |          |                      |          |  |        |                      |        |                      |   |           |   |           |   |             |   |           |  |          |                      |          |                      |          |                      |          |   |        |                      |        |                      |        |                      |        |                      |  |       |   |         |   |         |   |         |   |         |   |         |   |         |   |         |   |         |   |         |   |         |   |          |   |             |   |          |   |          |   |          |             |          |   |          |   |          |   |          |            |          |   |          |   |          |   |          |   |          |             |
| C<br>D      | 173H7100<br>171A5010  | C<br>D | 173H7100<br>171A5010 | C<br>D | 173H7100<br>171A5010 | C<br>D | 173H7100<br>171A5010 |   |           |             |          |    |           |    |           |    |           |   |             |   |          |   |          |   |          |  |        |                      |  |                      |                      |                      |                      |          |                      |           |                      |           |       |           |       |             |      |           |       |          |         |          |         |          |         |          |  |          |                      |          |  |        |                      |        |                      |   |           |   |           |   |             |   |           |  |          |                      |          |                      |          |                      |          |   |        |                      |        |                      |        |                      |        |                      |  |       |   |         |   |         |   |         |   |         |   |         |   |         |   |         |   |         |   |         |   |         |   |          |   |             |   |          |   |          |   |          |             |          |   |          |   |          |   |          |            |          |   |          |   |          |   |          |   |          |             |
|             | N° 17   |        | N° 47                |        | N° 2                 |        | N° 37                |   |           |             |          |    |           |    |           |    |           |   |             |   |          |   |          |   |          |  |        |                      |  |                      |                      |                      |                      |          |                      |           |                      |           |       |           |       |             |      |           |       |          |         |          |         |          |         |          |  |          |                      |          |  |        |                      |        |                      |   |           |   |           |   |             |   |           |  |          |                      |          |                      |          |                      |          |   |        |                      |        |                      |        |                      |        |                      |  |       |   |         |   |         |   |         |   |         |   |         |   |         |   |         |   |         |   |         |   |         |   |          |   |             |   |          |   |          |   |          |             |          |   |          |   |          |   |          |            |          |   |          |   |          |   |          |   |          |             |
| A           | 79B94.4   | A      | 79B94.4              | A      | 79B94.4              | A      | 79B94.4              |   |           |             |          |    |           |    |           |    |           |   |             |   |          |   |          |   |          |  |        |                      |  |                      |                      |                      |                      |          |                      |           |                      |           |       |           |       |             |      |           |       |          |         |          |         |          |         |          |  |          |                      |          |  |        |                      |        |                      |   |           |   |           |   |             |   |           |  |          |                      |          |                      |          |                      |          |   |        |                      |        |                      |        |                      |        |                      |  |       |   |         |   |         |   |         |   |         |   |         |   |         |   |         |   |         |   |         |   |         |   |          |   |             |   |          |   |          |   |          |             |          |   |          |   |          |   |          |            |          |   |          |   |          |   |          |   |          |             |
| B           | 79A94.4   | B      | 79A94.4              | B      | 79A94.4              | B      | 79A94.4              |   |           |             |          |    |           |    |           |    |           |   |             |   |          |   |          |   |          |  |        |                      |  |                      |                      |                      |                      |          |                      |           |                      |           |       |           |       |             |      |           |       |          |         |          |         |          |         |          |  |          |                      |          |  |        |                      |        |                      |   |           |   |           |   |             |   |           |  |          |                      |          |                      |          |                      |          |   |        |                      |        |                      |        |                      |        |                      |  |       |   |         |   |         |   |         |   |         |   |         |   |         |   |         |   |         |   |         |   |         |   |          |   |             |   |          |   |          |   |          |             |          |   |          |   |          |   |          |            |          |   |          |   |          |   |          |   |          |             |
| C           | 173H7100  | C      | 173H7100             | C      | 173H7100             | C      | 173H7100             |   |           |             |          |    |           |    |           |    |           |   |             |   |          |   |          |   |          |  |        |                      |  |                      |                      |                      |                      |          |                      |           |                      |           |       |           |       |             |      |           |       |          |         |          |         |          |         |          |  |          |                      |          |  |        |                      |        |                      |   |           |   |           |   |             |   |           |  |          |                      |          |                      |          |                      |          |   |        |                      |        |                      |        |                      |        |                      |  |       |   |         |   |         |   |         |   |         |   |         |   |         |   |         |   |         |   |         |   |         |   |          |   |             |   |          |   |          |   |          |             |          |   |          |   |          |   |          |            |          |   |          |   |          |   |          |   |          |             |
| D           | 171A5010  | D      | 171A5070             | D      | 171A5010             | D      | 171A5010             |   |           |             |          |    |           |    |           |    |           |   |             |   |          |   |          |   |          |  |        |                      |  |                      |                      |                      |                      |          |                      |           |                      |           |       |           |       |             |      |           |       |          |         |          |         |          |         |          |  |          |                      |          |  |        |                      |        |                      |   |           |   |           |   |             |   |           |  |          |                      |          |                      |          |                      |          |   |        |                      |        |                      |        |                      |        |                      |  |       |   |         |   |         |   |         |   |         |   |         |   |         |   |         |   |         |   |         |   |         |   |          |   |             |   |          |   |          |   |          |             |          |   |          |   |          |   |          |            |          |   |          |   |          |   |          |   |          |             |
| <b>+10°</b> | <table border="1"> <tr> <td>C<br/>D</td> <td>173H7100<br/>171A5010</td> <td>C<br/>D</td> <td>173H7100<br/>171A5010</td> </tr> <tr> <td></td> <td>N° 105 33</td> <td></td> <td>N° 102 33</td> </tr> <tr> <td>B1</td> <td>78C4568</td> <td>B1</td> <td>78C4568</td> </tr> <tr> <td>B2</td> <td>79C450BT</td> <td>B2</td> <td>79C450BT</td> </tr> <tr> <td>C</td> <td>173H7100</td> <td>C</td> <td>173H7100</td> </tr> <tr> <td>D</td> <td>171A5010</td> <td>D</td> <td>171A5010</td> </tr> </table> | C<br>D | 173H7100<br>171A5010 | C<br>D | 173H7100<br>171A5010 |        | N° 105 33            |   | N° 102 33 | B1          | 78C4568  | B1 | 78C4568   | B2 | 79C450BT  | B2 | 79C450BT  | C | 173H7100    | C | 173H7100 | D | 171A5010 | D   | 171A5010 | <table border="1"> <tr> <td>C<br/>D</td> <td>173H7100<br/>171A5010</td> <td>C<br/>D</td> <td>173H7100<br/>171A5010</td> <td>C<br/>D</td> <td>173H7100<br/>171A5010</td> </tr> <tr> <td></td> <td>N° 94 48</td> <td></td> <td>N° 86 48</td> <td></td> <td>N° 79 45</td> </tr> <tr> <td>B</td> <td>79A0555.T</td> <td>B</td> <td>79A0555.T</td> <td>B</td> <td>79A0555.T</td> </tr> <tr> <td>C</td> <td>175H7190</td> <td>C</td> <td>173H7130</td> <td>C</td> <td>173H7100</td> </tr> <tr> <td>D</td> <td>171A5500</td> <td>D</td> <td>171A5500</td> <td>D</td> <td>171A5500</td> </tr> </table> | C<br>D | 173H7100<br>171A5010 | C<br>D   | 173H7100<br>171A5010 | C<br>D               | 173H7100<br>171A5010 |                      | N° 94 48 |                      | N° 86 48  |                      | N° 79 45  | B     | 79A0555.T | B     | 79A0555.T   | B    | 79A0555.T | C     | 175H7190 | C       | 173H7130 | C       | 173H7100 | D       | 171A5500 | D  | 171A5500 | D                    | 171A5500 | <table border="1"> <tr> <td>C<br/>D</td> <td>173H7100<br/>171A5010</td> <td>C<br/>D</td> <td>173H7100<br/>171A5010</td> </tr> <tr> <td></td> <td>N° 71 54</td> <td></td> <td>N° 64 45</td> </tr> <tr> <td>B</td> <td>79A4105.T</td> <td>B</td> <td>79A4105.T</td> </tr> <tr> <td>C</td> <td>175H7190</td> <td>C</td> <td>173H7100</td> </tr> <tr> <td>D</td> <td>171A5500</td> <td>D</td> <td>171A5500</td> </tr> </table> | C<br>D | 173H7100<br>171A5010 | C<br>D | 173H7100<br>171A5010 |   | N° 71 54  |   | N° 64 45  | B | 79A4105.T   | B | 79A4105.T | C  | 175H7190 | C                    | 173H7100 | D                    | 171A5500 | D                    | 171A5500 | <table border="1"> <tr> <td>C<br/>D</td> <td>173H7100<br/>171A5010</td> <td>C<br/>D</td> <td>173H7100<br/>171A5010</td> <td>C<br/>D</td> <td>173H7100<br/>171A5010</td> <td>C<br/>D</td> <td>173H7100<br/>171A5010</td> </tr> <tr> <td></td> <td>N° 55</td> <td></td> <td>N° 18</td> <td></td> <td>N° 48</td> <td></td> <td>N° 3</td> <td></td> <td>N° 38</td> </tr> <tr> <td>A</td> <td>79B95.5</td> <td>A</td> <td>79B95.5</td> <td>A</td> <td>79B95.5</td> <td>A</td> <td>79B94.4</td> <td>A</td> <td>79B94.4</td> </tr> <tr> <td>B</td> <td>79A95.5</td> <td>B</td> <td>79A95.5</td> <td>B</td> <td>79A95.5</td> <td>B</td> <td>79A94.4</td> <td>B</td> <td>79A94.4</td> </tr> <tr> <td>C</td> <td>173H7100</td> <td>C</td> <td>175H7190</td> <td>C</td> <td>173H7130</td> <td>C</td> <td>175H7190</td> <td>C</td> <td>175H9160</td> </tr> <tr> <td>D</td> <td>171A5500</td> <td>D</td> <td>171A5500</td> <td>D</td> <td>171A5500</td> <td>D</td> <td>171A5500</td> <td>D</td> <td>171A5500</td> </tr> </table> | C<br>D | 173H7100<br>171A5010 | C<br>D | 173H7100<br>171A5010 | C<br>D | 173H7100<br>171A5010 | C<br>D | 173H7100<br>171A5010 |  | N° 55 |   | N° 18   |   | N° 48   |   | N° 3    |   | N° 38   | A | 79B95.5 | A | 79B95.5 | A | 79B95.5 | A | 79B94.4 | A | 79B94.4 | B | 79A95.5 | B | 79A95.5  | B | 79A95.5     | B | 79A94.4  | B | 79A94.4  | C | 173H7100 | C           | 175H7190 | C | 173H7130 | C | 175H7190 | C | 175H9160 | D          | 171A5500 | D | 171A5500 | D | 171A5500 | D | 171A5500 | D | 171A5500 | <b>+10°</b> |
| C<br>D      | 173H7100<br>171A5010  | C<br>D | 173H7100<br>171A5010 |        |                      |        |                      |   |           |             |          |    |           |    |           |    |           |   |             |   |          |   |          |   |          |  |        |                      |  |                      |                      |                      |                      |          |                      |           |                      |           |       |           |       |             |      |           |       |          |         |          |         |          |         |          |  |          |                      |          |  |        |                      |        |                      |   |           |   |           |   |             |   |           |  |          |                      |          |                      |          |                      |          |   |        |                      |        |                      |        |                      |        |                      |  |       |   |         |   |         |   |         |   |         |   |         |   |         |   |         |   |         |   |         |   |         |   |          |   |             |   |          |   |          |   |          |             |          |   |          |   |          |   |          |            |          |   |          |   |          |   |          |   |          |             |
|             | N° 105 33   |        | N° 102 33            |        |                      |        |                      |   |           |             |          |    |           |    |           |    |           |   |             |   |          |   |          |   |          |  |        |                      |  |                      |                      |                      |                      |          |                      |           |                      |           |       |           |       |             |      |           |       |          |         |          |         |          |         |          |  |          |                      |          |  |        |                      |        |                      |   |           |   |           |   |             |   |           |  |          |                      |          |                      |          |                      |          |   |        |                      |        |                      |        |                      |        |                      |  |       |   |         |   |         |   |         |   |         |   |         |   |         |   |         |   |         |   |         |   |         |   |          |   |             |   |          |   |          |   |          |             |          |   |          |   |          |   |          |            |          |   |          |   |          |   |          |   |          |             |
| B1          | 78C4568   | B1     | 78C4568              |        |                      |        |                      |   |           |             |          |    |           |    |           |    |           |   |             |   |          |   |          |   |          |  |        |                      |  |                      |                      |                      |                      |          |                      |           |                      |           |       |           |       |             |      |           |       |          |         |          |         |          |         |          |  |          |                      |          |  |        |                      |        |                      |   |           |   |           |   |             |   |           |  |          |                      |          |                      |          |                      |          |   |        |                      |        |                      |        |                      |        |                      |  |       |   |         |   |         |   |         |   |         |   |         |   |         |   |         |   |         |   |         |   |         |   |          |   |             |   |          |   |          |   |          |             |          |   |          |   |          |   |          |            |          |   |          |   |          |   |          |   |          |             |
| B2          | 79C450BT  | B2     | 79C450BT             |        |                      |        |                      |   |           |             |          |    |           |    |           |    |           |   |             |   |          |   |          |   |          |  |        |                      |  |                      |                      |                      |                      |          |                      |           |                      |           |       |           |       |             |      |           |       |          |         |          |         |          |         |          |  |          |                      |          |  |        |                      |        |                      |   |           |   |           |   |             |   |           |  |          |                      |          |                      |          |                      |          |   |        |                      |        |                      |        |                      |        |                      |  |       |   |         |   |         |   |         |   |         |   |         |   |         |   |         |   |         |   |         |   |         |   |          |   |             |   |          |   |          |   |          |             |          |   |          |   |          |   |          |            |          |   |          |   |          |   |          |   |          |             |
| C           | 173H7100  | C      | 173H7100             |        |                      |        |                      |   |           |             |          |    |           |    |           |    |           |   |             |   |          |   |          |   |          |  |        |                      |  |                      |                      |                      |                      |          |                      |           |                      |           |       |           |       |             |      |           |       |          |         |          |         |          |         |          |  |          |                      |          |  |        |                      |        |                      |   |           |   |           |   |             |   |           |  |          |                      |          |                      |          |                      |          |   |        |                      |        |                      |        |                      |        |                      |  |       |   |         |   |         |   |         |   |         |   |         |   |         |   |         |   |         |   |         |   |         |   |          |   |             |   |          |   |          |   |          |             |          |   |          |   |          |   |          |            |          |   |          |   |          |   |          |   |          |             |
| D           | 171A5010  | D      | 171A5010             |        |                      |        |                      |   |           |             |          |    |           |    |           |    |           |   |             |   |          |   |          |   |          |  |        |                      |  |                      |                      |                      |                      |          |                      |           |                      |           |       |           |       |             |      |           |       |          |         |          |         |          |         |          |  |          |                      |          |  |        |                      |        |                      |   |           |   |           |   |             |   |           |  |          |                      |          |                      |          |                      |          |   |        |                      |        |                      |        |                      |        |                      |  |       |   |         |   |         |   |         |   |         |   |         |   |         |   |         |   |         |   |         |   |         |   |          |   |             |   |          |   |          |   |          |             |          |   |          |   |          |   |          |            |          |   |          |   |          |   |          |   |          |             |
| C<br>D      | 173H7100<br>171A5010  | C<br>D | 173H7100<br>171A5010 | C<br>D | 173H7100<br>171A5010 |        |                      |   |           |             |          |    |           |    |           |    |           |   |             |   |          |   |          |   |          |  |        |                      |  |                      |                      |                      |                      |          |                      |           |                      |           |       |           |       |             |      |           |       |          |         |          |         |          |         |          |  |          |                      |          |  |        |                      |        |                      |   |           |   |           |   |             |   |           |  |          |                      |          |                      |          |                      |          |   |        |                      |        |                      |        |                      |        |                      |  |       |   |         |   |         |   |         |   |         |   |         |   |         |   |         |   |         |   |         |   |         |   |          |   |             |   |          |   |          |   |          |             |          |   |          |   |          |   |          |            |          |   |          |   |          |   |          |   |          |             |
|             | N° 94 48  |        | N° 86 48             |        | N° 79 45             |        |                      |   |           |             |          |    |           |    |           |    |           |   |             |   |          |   |          |   |          |  |        |                      |  |                      |                      |                      |                      |          |                      |           |                      |           |       |           |       |             |      |           |       |          |         |          |         |          |         |          |  |          |                      |          |  |        |                      |        |                      |   |           |   |           |   |             |   |           |  |          |                      |          |                      |          |                      |          |   |        |                      |        |                      |        |                      |        |                      |  |       |   |         |   |         |   |         |   |         |   |         |   |         |   |         |   |         |   |         |   |         |   |          |   |             |   |          |   |          |   |          |             |          |   |          |   |          |   |          |            |          |   |          |   |          |   |          |   |          |             |
| B           | 79A0555.T   | B      | 79A0555.T            | B      | 79A0555.T            |        |                      |   |           |             |          |    |           |    |           |    |           |   |             |   |          |   |          |   |          |  |        |                      |  |                      |                      |                      |                      |          |                      |           |                      |           |       |           |       |             |      |           |       |          |         |          |         |          |         |          |  |          |                      |          |  |        |                      |        |                      |   |           |   |           |   |             |   |           |  |          |                      |          |                      |          |                      |          |   |        |                      |        |                      |        |                      |        |                      |  |       |   |         |   |         |   |         |   |         |   |         |   |         |   |         |   |         |   |         |   |         |   |          |   |             |   |          |   |          |   |          |             |          |   |          |   |          |   |          |            |          |   |          |   |          |   |          |   |          |             |
| C           | 175H7190  | C      | 173H7130             | C      | 173H7100             |        |                      |   |           |             |          |    |           |    |           |    |           |   |             |   |          |   |          |   |          |  |        |                      |  |                      |                      |                      |                      |          |                      |           |                      |           |       |           |       |             |      |           |       |          |         |          |         |          |         |          |  |          |                      |          |  |        |                      |        |                      |   |           |   |           |   |             |   |           |  |          |                      |          |                      |          |                      |          |   |        |                      |        |                      |        |                      |        |                      |  |       |   |         |   |         |   |         |   |         |   |         |   |         |   |         |   |         |   |         |   |         |   |          |   |             |   |          |   |          |   |          |             |          |   |          |   |          |   |          |            |          |   |          |   |          |   |          |   |          |             |
| D           | 171A5500  | D      | 171A5500             | D      | 171A5500             |        |                      |   |           |             |          |    |           |    |           |    |           |   |             |   |          |   |          |   |          |  |        |                      |  |                      |                      |                      |                      |          |                      |           |                      |           |       |           |       |             |      |           |       |          |         |          |         |          |         |          |  |          |                      |          |  |        |                      |        |                      |   |           |   |           |   |             |   |           |  |          |                      |          |                      |          |                      |          |   |        |                      |        |                      |        |                      |        |                      |  |       |   |         |   |         |   |         |   |         |   |         |   |         |   |         |   |         |   |         |   |         |   |          |   |             |   |          |   |          |   |          |             |          |   |          |   |          |   |          |            |          |   |          |   |          |   |          |   |          |             |
| C<br>D      | 173H7100<br>171A5010  | C<br>D | 173H7100<br>171A5010 |        |                      |        |                      |   |           |             |          |    |           |    |           |    |           |   |             |   |          |   |          |   |          |  |        |                      |  |                      |                      |                      |                      |          |                      |           |                      |           |       |           |       |             |      |           |       |          |         |          |         |          |         |          |  |          |                      |          |  |        |                      |        |                      |   |           |   |           |   |             |   |           |  |          |                      |          |                      |          |                      |          |   |        |                      |        |                      |        |                      |        |                      |  |       |   |         |   |         |   |         |   |         |   |         |   |         |   |         |   |         |   |         |   |         |   |          |   |             |   |          |   |          |   |          |             |          |   |          |   |          |   |          |            |          |   |          |   |          |   |          |   |          |             |
|             | N° 71 54  |        | N° 64 45             |        |                      |        |                      |   |           |             |          |    |           |    |           |    |           |   |             |   |          |   |          |   |          |  |        |                      |  |                      |                      |                      |                      |          |                      |           |                      |           |       |           |       |             |      |           |       |          |         |          |         |          |         |          |  |          |                      |          |  |        |                      |        |                      |   |           |   |           |   |             |   |           |  |          |                      |          |                      |          |                      |          |   |        |                      |        |                      |        |                      |        |                      |  |       |   |         |   |         |   |         |   |         |   |         |   |         |   |         |   |         |   |         |   |         |   |          |   |             |   |          |   |          |   |          |             |          |   |          |   |          |   |          |            |          |   |          |   |          |   |          |   |          |             |
| B           | 79A4105.T   | B      | 79A4105.T            |        |                      |        |                      |   |           |             |          |    |           |    |           |    |           |   |             |   |          |   |          |   |          |  |        |                      |  |                      |                      |                      |                      |          |                      |           |                      |           |       |           |       |             |      |           |       |          |         |          |         |          |         |          |  |          |                      |          |  |        |                      |        |                      |   |           |   |           |   |             |   |           |  |          |                      |          |                      |          |                      |          |   |        |                      |        |                      |        |                      |        |                      |  |       |   |         |   |         |   |         |   |         |   |         |   |         |   |         |   |         |   |         |   |         |   |          |   |             |   |          |   |          |   |          |             |          |   |          |   |          |   |          |            |          |   |          |   |          |   |          |   |          |             |
| C           | 175H7190  | C      | 173H7100             |        |                      |        |                      |   |           |             |          |    |           |    |           |    |           |   |             |   |          |   |          |   |          |  |        |                      |  |                      |                      |                      |                      |          |                      |           |                      |           |       |           |       |             |      |           |       |          |         |          |         |          |         |          |  |          |                      |          |  |        |                      |        |                      |   |           |   |           |   |             |   |           |  |          |                      |          |                      |          |                      |          |   |        |                      |        |                      |        |                      |        |                      |  |       |   |         |   |         |   |         |   |         |   |         |   |         |   |         |   |         |   |         |   |         |   |          |   |             |   |          |   |          |   |          |             |          |   |          |   |          |   |          |            |          |   |          |   |          |   |          |   |          |             |
| D           | 171A5500  | D      | 171A5500             |        |                      |        |                      |   |           |             |          |    |           |    |           |    |           |   |             |   |          |   |          |   |          |  |        |                      |  |                      |                      |                      |                      |          |                      |           |                      |           |       |           |       |             |      |           |       |          |         |          |         |          |         |          |  |          |                      |          |  |        |                      |        |                      |   |           |   |           |   |             |   |           |  |          |                      |          |                      |          |                      |          |   |        |                      |        |                      |        |                      |        |                      |  |       |   |         |   |         |   |         |   |         |   |         |   |         |   |         |   |         |   |         |   |         |   |          |   |             |   |          |   |          |   |          |             |          |   |          |   |          |   |          |            |          |   |          |   |          |   |          |   |          |             |
| C<br>D      | 173H7100<br>171A5010  | C<br>D | 173H7100<br>171A5010 | C<br>D | 173H7100<br>171A5010 | C<br>D | 173H7100<br>171A5010 |   |           |             |          |    |           |    |           |    |           |   |             |   |          |   |          |   |          |  |        |                      |  |                      |                      |                      |                      |          |                      |           |                      |           |       |           |       |             |      |           |       |          |         |          |         |          |         |          |  |          |                      |          |  |        |                      |        |                      |   |           |   |           |   |             |   |           |  |          |                      |          |                      |          |                      |          |   |        |                      |        |                      |        |                      |        |                      |  |       |   |         |   |         |   |         |   |         |   |         |   |         |   |         |   |         |   |         |   |         |   |          |   |             |   |          |   |          |   |          |             |          |   |          |   |          |   |          |            |          |   |          |   |          |   |          |   |          |             |
|             | N° 55   |        | N° 18                |        | N° 48                |        | N° 3                 |   | N° 38     |             |          |    |           |    |           |    |           |   |             |   |          |   |          |   |          |  |        |                      |  |                      |                      |                      |                      |          |                      |           |                      |           |       |           |       |             |      |           |       |          |         |          |         |          |         |          |  |          |                      |          |  |        |                      |        |                      |   |           |   |           |   |             |   |           |  |          |                      |          |                      |          |                      |          |   |        |                      |        |                      |        |                      |        |                      |  |       |   |         |   |         |   |         |   |         |   |         |   |         |   |         |   |         |   |         |   |         |   |          |   |             |   |          |   |          |   |          |             |          |   |          |   |          |   |          |            |          |   |          |   |          |   |          |   |          |             |
| A           | 79B95.5   | A      | 79B95.5              | A      | 79B95.5              | A      | 79B94.4              | A | 79B94.4   |             |          |    |           |    |           |    |           |   |             |   |          |   |          |   |          |  |        |                      |  |                      |                      |                      |                      |          |                      |           |                      |           |       |           |       |             |      |           |       |          |         |          |         |          |         |          |  |          |                      |          |  |        |                      |        |                      |   |           |   |           |   |             |   |           |  |          |                      |          |                      |          |                      |          |   |        |                      |        |                      |        |                      |        |                      |  |       |   |         |   |         |   |         |   |         |   |         |   |         |   |         |   |         |   |         |   |         |   |          |   |             |   |          |   |          |   |          |             |          |   |          |   |          |   |          |            |          |   |          |   |          |   |          |   |          |             |
| B           | 79A95.5   | B      | 79A95.5              | B      | 79A95.5              | B      | 79A94.4              | B | 79A94.4   |             |          |    |           |    |           |    |           |   |             |   |          |   |          |   |          |  |        |                      |  |                      |                      |                      |                      |          |                      |           |                      |           |       |           |       |             |      |           |       |          |         |          |         |          |         |          |  |          |                      |          |  |        |                      |        |                      |   |           |   |           |   |             |   |           |  |          |                      |          |                      |          |                      |          |   |        |                      |        |                      |        |                      |        |                      |  |       |   |         |   |         |   |         |   |         |   |         |   |         |   |         |   |         |   |         |   |         |   |          |   |             |   |          |   |          |   |          |             |          |   |          |   |          |   |          |            |          |   |          |   |          |   |          |   |          |             |
| C           | 173H7100  | C      | 175H7190             | C      | 173H7130             | C      | 175H7190             | C | 175H9160  |             |          |    |           |    |           |    |           |   |             |   |          |   |          |   |          |  |        |                      |  |                      |                      |                      |                      |          |                      |           |                      |           |       |           |       |             |      |           |       |          |         |          |         |          |         |          |  |          |                      |          |  |        |                      |        |                      |   |           |   |           |   |             |   |           |  |          |                      |          |                      |          |                      |          |   |        |                      |        |                      |        |                      |        |                      |  |       |   |         |   |         |   |         |   |         |   |         |   |         |   |         |   |         |   |         |   |         |   |          |   |             |   |          |   |          |   |          |             |          |   |          |   |          |   |          |            |          |   |          |   |          |   |          |   |          |             |
| D           | 171A5500  | D      | 171A5500             | D      | 171A5500             | D      | 171A5500             | D | 171A5500  |             |          |    |           |    |           |    |           |   |             |   |          |   |          |   |          |  |        |                      |  |                      |                      |                      |                      |          |                      |           |                      |           |       |           |       |             |      |           |       |          |         |          |         |          |         |          |  |          |                      |          |  |        |                      |        |                      |   |           |   |           |   |             |   |           |  |          |                      |          |                      |          |                      |          |   |        |                      |        |                      |        |                      |        |                      |  |       |   |         |   |         |   |         |   |         |   |         |   |         |   |         |   |         |   |         |   |         |   |          |   |             |   |          |   |          |   |          |             |          |   |          |   |          |   |          |            |          |   |          |   |          |   |          |   |          |             |
| <b>+15°</b> | <table border="1"> <tr> <td>C<br/>D</td> <td>173H7100<br/>171A5010</td> <td>C<br/>D</td> <td>173H7100<br/>171A5010</td> </tr> <tr> <td></td> <td>N° 95 48</td> <td></td> <td>N° 87 48</td> <td></td> <td>N° 80 37</td> </tr> <tr> <td>B</td> <td>79A0555.T</td> <td>B</td> <td>79A0555.T</td> <td>B</td> <td>79A0555.T</td> </tr> <tr> <td>C</td> <td>175H7190.22</td> <td>C</td> <td>175H7190</td> <td>C</td> <td>173H7100</td> </tr> </table>   | C<br>D | 173H7100<br>171A5010 | C<br>D | 173H7100<br>171A5010 |        | N° 95 48             |   | N° 87 48  |             | N° 80 37 | B  | 79A0555.T | B  | 79A0555.T | B  | 79A0555.T | C | 175H7190.22 | C | 175H7190 | C | 173H7100 | <table border="1"> <tr> <td>C<br/>D</td> <td>173H7100<br/>171A5010</td> <td>C<br/>D</td> <td>173H7100<br/>171A5010</td> </tr> <tr> <td></td> <td>N° 96 48</td> <td></td> <td>N° 88 45</td> <td></td> <td>N° 81 37</td> </tr> <tr> <td>B</td> <td>79A0555.T</td> <td>B</td> <td>79A0555.T</td> <td>B</td> <td>79A0555.T</td> </tr> <tr> <td>C</td> <td>175H7190.22</td> <td>C</td> <td>173H7130</td> <td>C</td> <td>173H7100</td> </tr> <tr> <td>D</td> <td>171A5040</td> <td>D</td> <td>171A5070</td> <td>D</td> <td>171A5010</td> </tr> </table> | C<br>D   | 173H7100<br>171A5010   | C<br>D | 173H7100<br>171A5010 |  | N° 96 48             |                      | N° 88 45             |                      | N° 81 37 | B                    | 79A0555.T | B                    | 79A0555.T | B     | 79A0555.T | C     | 175H7190.22 | C    | 173H7130  | C     | 173H7100 | D       | 171A5040 | D       | 171A5070 | D       | 171A5010 | <table border="1"> <tr> <td>C<br/>D</td> <td>173H7100<br/>171A5010</td> <td>C<br/>D</td> <td>173H7100<br/>171A5010</td> </tr> <tr> <td></td> <td>N° 72 54</td> <td></td> <td>N° 65 37</td> </tr> <tr> <td>B</td> <td>79A4105.T</td> <td>B</td> <td>79A4105.T</td> </tr> <tr> <td>C</td> <td>175H7190.22</td> <td>C</td> <td>173H7100</td> </tr> </table> | C<br>D   | 173H7100<br>171A5010 | C<br>D   | 173H7100<br>171A5010   |        | N° 72 54             |        | N° 65 37             | B | 79A4105.T | B | 79A4105.T | C | 175H7190.22 | C | 173H7100  | <table border="1"> <tr> <td>C<br/>D</td> <td>173H7100<br/>171A5010</td> <td>C<br/>D</td> <td>173H7100<br/>171A5010</td> <td>C<br/>D</td> <td>173H7100<br/>171A5010</td> <td>C<br/>D</td> <td>173H7100<br/>171A5010</td> </tr> <tr> <td></td> <td>N° 56</td> <td></td> <td>N° 19</td> <td></td> <td>N° 49</td> <td></td> <td>N° 4</td> <td></td> <td>N° 39</td> </tr> <tr> <td>A</td> <td>79B95.5</td> <td>A</td> <td>79B95.5</td> <td>A</td> <td>79B95.5</td> <td>A</td> <td>79B95.5</td> <td>A</td> <td>79B94.4</td> </tr> <tr> <td>B</td> <td>79A95.5</td> <td>B</td> <td>79A95.5</td> <td>B</td> <td>79A95.5</td> <td>B</td> <td>79A94.4</td> <td>B</td> <td>79A94.4</td> </tr> <tr> <td>C</td> <td>175H9160</td> <td>C</td> <td>175H7190.22</td> <td>C</td> <td>175H7190</td> <td>C</td> <td>173H7100</td> <td>C</td> <td>173H7100</td> </tr> </table> | C<br>D   | 173H7100<br>171A5010 | C<br>D   | 173H7100<br>171A5010 | C<br>D   | 173H7100<br>171A5010 | C<br>D   | 173H7100<br>171A5010  |        | N° 56                |        | N° 19                |        | N° 49                |        | N° 4                 |  | N° 39 | A | 79B95.5 | A | 79B95.5 | A | 79B95.5 | A | 79B95.5 | A | 79B94.4 | B | 79A95.5 | B | 79A95.5 | B | 79A95.5 | B | 79A94.4 | B | 79A94.4 | C | 175H9160 | C | 175H7190.22 | C | 175H7190 | C | 173H7100 | C | 173H7100 | <b>+15°</b> |          |   |          |   |          |   |          |            |          |   |          |   |          |   |          |   |          |             |
| C<br>D      | 173H7100<br>171A5010  | C<br>D | 173H7100<br>171A5010 |        |                      |        |                      |   |           |             |          |    |           |    |           |    |           |   |             |   |          |   |          |   |          |  |        |                      |  |                      |                      |                      |                      |          |                      |           |                      |           |       |           |       |             |      |           |       |          |         |          |         |          |         |          |  |          |                      |          |  |        |                      |        |                      |   |           |   |           |   |             |   |           |  |          |                      |          |                      |          |                      |          |   |        |                      |        |                      |        |                      |        |                      |  |       |   |         |   |         |   |         |   |         |   |         |   |         |   |         |   |         |   |         |   |         |   |          |   |             |   |          |   |          |   |          |             |          |   |          |   |          |   |          |            |          |   |          |   |          |   |          |   |          |             |
|             | N° 95 48  |        | N° 87 48             |        | N° 80 37             |        |                      |   |           |             |          |    |           |    |           |    |           |   |             |   |          |   |          |   |          |  |        |                      |  |                      |                      |                      |                      |          |                      |           |                      |           |       |           |       |             |      |           |       |          |         |          |         |          |         |          |  |          |                      |          |  |        |                      |        |                      |   |           |   |           |   |             |   |           |  |          |                      |          |                      |          |                      |          |   |        |                      |        |                      |        |                      |        |                      |  |       |   |         |   |         |   |         |   |         |   |         |   |         |   |         |   |         |   |         |   |         |   |          |   |             |   |          |   |          |   |          |             |          |   |          |   |          |   |          |            |          |   |          |   |          |   |          |   |          |             |
| B           | 79A0555.T   | B      | 79A0555.T            | B      | 79A0555.T            |        |                      |   |           |             |          |    |           |    |           |    |           |   |             |   |          |   |          |   |          |  |        |                      |  |                      |                      |                      |                      |          |                      |           |                      |           |       |           |       |             |      |           |       |          |         |          |         |          |         |          |  |          |                      |          |  |        |                      |        |                      |   |           |   |           |   |             |   |           |  |          |                      |          |                      |          |                      |          |   |        |                      |        |                      |        |                      |        |                      |  |       |   |         |   |         |   |         |   |         |   |         |   |         |   |         |   |         |   |         |   |         |   |          |   |             |   |          |   |          |   |          |             |          |   |          |   |          |   |          |            |          |   |          |   |          |   |          |   |          |             |
| C           | 175H7190.22   | C      | 175H7190             | C      | 173H7100             |        |                      |   |           |             |          |    |           |    |           |    |           |   |             |   |          |   |          |   |          |  |        |                      |  |                      |                      |                      |                      |          |                      |           |                      |           |       |           |       |             |      |           |       |          |         |          |         |          |         |          |  |          |                      |          |  |        |                      |        |                      |   |           |   |           |   |             |   |           |  |          |                      |          |                      |          |                      |          |   |        |                      |        |                      |        |                      |        |                      |  |       |   |         |   |         |   |         |   |         |   |         |   |         |   |         |   |         |   |         |   |         |   |          |   |             |   |          |   |          |   |          |             |          |   |          |   |          |   |          |            |          |   |          |   |          |   |          |   |          |             |
| C<br>D      | 173H7100<br>171A5010  | C<br>D | 173H7100<br>171A5010 |        |                      |        |                      |   |           |             |          |    |           |    |           |    |           |   |             |   |          |   |          |   |          |  |        |                      |  |                      |                      |                      |                      |          |                      |           |                      |           |       |           |       |             |      |           |       |          |         |          |         |          |         |          |  |          |                      |          |  |        |                      |        |                      |   |           |   |           |   |             |   |           |  |          |                      |          |                      |          |                      |          |   |        |                      |        |                      |        |                      |        |                      |  |       |   |         |   |         |   |         |   |         |   |         |   |         |   |         |   |         |   |         |   |         |   |          |   |             |   |          |   |          |   |          |             |          |   |          |   |          |   |          |            |          |   |          |   |          |   |          |   |          |             |
|             | N° 96 48  |        | N° 88 45             |        | N° 81 37             |        |                      |   |           |             |          |    |           |    |           |    |           |   |             |   |          |   |          |   |          |  |        |                      |  |                      |                      |                      |                      |          |                      |           |                      |           |       |           |       |             |      |           |       |          |         |          |         |          |         |          |  |          |                      |          |  |        |                      |        |                      |   |           |   |           |   |             |   |           |  |          |                      |          |                      |          |                      |          |   |        |                      |        |                      |        |                      |        |                      |  |       |   |         |   |         |   |         |   |         |   |         |   |         |   |         |   |         |   |         |   |         |   |          |   |             |   |          |   |          |   |          |             |          |   |          |   |          |   |          |            |          |   |          |   |          |   |          |   |          |             |
| B           | 79A0555.T   | B      | 79A0555.T            | B      | 79A0555.T            |        |                      |   |           |             |          |    |           |    |           |    |           |   |             |   |          |   |          |   |          |  |        |                      |  |                      |                      |                      |                      |          |                      |           |                      |           |       |           |       |             |      |           |       |          |         |          |         |          |         |          |  |          |                      |          |  |        |                      |        |                      |   |           |   |           |   |             |   |           |  |          |                      |          |                      |          |                      |          |   |        |                      |        |                      |        |                      |        |                      |  |       |   |         |   |         |   |         |   |         |   |         |   |         |   |         |   |         |   |         |   |         |   |          |   |             |   |          |   |          |   |          |             |          |   |          |   |          |   |          |            |          |   |          |   |          |   |          |   |          |             |
| C           | 175H7190.22   | C      | 173H7130             | C      | 173H7100             |        |                      |   |           |             |          |    |           |    |           |    |           |   |             |   |          |   |          |   |          |  |        |                      |  |                      |                      |                      |                      |          |                      |           |                      |           |       |           |       |             |      |           |       |          |         |          |         |          |         |          |  |          |                      |          |  |        |                      |        |                      |   |           |   |           |   |             |   |           |  |          |                      |          |                      |          |                      |          |   |        |                      |        |                      |        |                      |        |                      |  |       |   |         |   |         |   |         |   |         |   |         |   |         |   |         |   |         |   |         |   |         |   |          |   |             |   |          |   |          |   |          |             |          |   |          |   |          |   |          |            |          |   |          |   |          |   |          |   |          |             |
| D           | 171A5040  | D      | 171A5070             | D      | 171A5010             |        |                      |   |           |             |          |    |           |    |           |    |           |   |             |   |          |   |          |   |          |  |        |                      |  |                      |                      |                      |                      |          |                      |           |                      |           |       |           |       |             |      |           |       |          |         |          |         |          |         |          |  |          |                      |          |  |        |                      |        |                      |   |           |   |           |   |             |   |           |  |          |                      |          |                      |          |                      |          |   |        |                      |        |                      |        |                      |        |                      |  |       |   |         |   |         |   |         |   |         |   |         |   |         |   |         |   |         |   |         |   |         |   |          |   |             |   |          |   |          |   |          |             |          |   |          |   |          |   |          |            |          |   |          |   |          |   |          |   |          |             |
| C<br>D      | 173H7100<br>171A5010  | C<br>D | 173H7100<br>171A5010 |        |                      |        |                      |   |           |             |          |    |           |    |           |    |           |   |             |   |          |   |          |   |          |  |        |                      |  |                      |                      |                      |                      |          |                      |           |                      |           |       |           |       |             |      |           |       |          |         |          |         |          |         |          |  |          |                      |          |  |        |                      |        |                      |   |           |   |           |   |             |   |           |  |          |                      |          |                      |          |                      |          |   |        |                      |        |                      |        |                      |        |                      |  |       |   |         |   |         |   |         |   |         |   |         |   |         |   |         |   |         |   |         |   |         |   |          |   |             |   |          |   |          |   |          |             |          |   |          |   |          |   |          |            |          |   |          |   |          |   |          |   |          |             |
|             | N° 72 54  |        | N° 65 37             |        |                      |        |                      |   |           |             |          |    |           |    |           |    |           |   |             |   |          |   |          |   |          |  |        |                      |  |                      |                      |                      |                      |          |                      |           |                      |           |       |           |       |             |      |           |       |          |         |          |         |          |         |          |  |          |                      |          |  |        |                      |        |                      |   |           |   |           |   |             |   |           |  |          |                      |          |                      |          |                      |          |   |        |                      |        |                      |        |                      |        |                      |  |       |   |         |   |         |   |         |   |         |   |         |   |         |   |         |   |         |   |         |   |         |   |          |   |             |   |          |   |          |   |          |             |          |   |          |   |          |   |          |            |          |   |          |   |          |   |          |   |          |             |
| B           | 79A4105.T   | B      | 79A4105.T            |        |                      |        |                      |   |           |             |          |    |           |    |           |    |           |   |             |   |          |   |          |   |          |  |        |                      |  |                      |                      |                      |                      |          |                      |           |                      |           |       |           |       |             |      |           |       |          |         |          |         |          |         |          |  |          |                      |          |  |        |                      |        |                      |   |           |   |           |   |             |   |           |  |          |                      |          |                      |          |                      |          |   |        |                      |        |                      |        |                      |        |                      |  |       |   |         |   |         |   |         |   |         |   |         |   |         |   |         |   |         |   |         |   |         |   |          |   |             |   |          |   |          |   |          |             |          |   |          |   |          |   |          |            |          |   |          |   |          |   |          |   |          |             |
| C           | 175H7190.22   | C      | 173H7100             |        |                      |        |                      |   |           |             |          |    |           |    |           |    |           |   |             |   |          |   |          |   |          |  |        |                      |  |                      |                      |                      |                      |          |                      |           |                      |           |       |           |       |             |      |           |       |          |         |          |         |          |         |          |  |          |                      |          |  |        |                      |        |                      |   |           |   |           |   |             |   |           |  |          |                      |          |                      |          |                      |          |   |        |                      |        |                      |        |                      |        |                      |  |       |   |         |   |         |   |         |   |         |   |         |   |         |   |         |   |         |   |         |   |         |   |          |   |             |   |          |   |          |   |          |             |          |   |          |   |          |   |          |            |          |   |          |   |          |   |          |   |          |             |
| C<br>D      | 173H7100<br>171A5010  | C<br>D | 173H7100<br>171A5010 | C<br>D | 173H7100<br>171A5010 | C<br>D | 173H7100<br>171A5010 |   |           |             |          |    |           |    |           |    |           |   |             |   |          |   |          |   |          |  |        |                      |  |                      |                      |                      |                      |          |                      |           |                      |           |       |           |       |             |      |           |       |          |         |          |         |          |         |          |  |          |                      |          |  |        |                      |        |                      |   |           |   |           |   |             |   |           |  |          |                      |          |                      |          |                      |          |   |        |                      |        |                      |        |                      |        |                      |  |       |   |         |   |         |   |         |   |         |   |         |   |         |   |         |   |         |   |         |   |         |   |          |   |             |   |          |   |          |   |          |             |          |   |          |   |          |   |          |            |          |   |          |   |          |   |          |   |          |             |
|             | N° 56   |        | N° 19                |        | N° 49                |        | N° 4                 |   | N° 39     |             |          |    |           |    |           |    |           |   |             |   |          |   |          |   |          |  |        |                      |  |                      |                      |                      |                      |          |                      |           |                      |           |       |           |       |             |      |           |       |          |         |          |         |          |         |          |  |          |                      |          |  |        |                      |        |                      |   |           |   |           |   |             |   |           |  |          |                      |          |                      |          |                      |          |   |        |                      |        |                      |        |                      |        |                      |  |       |   |         |   |         |   |         |   |         |   |         |   |         |   |         |   |         |   |         |   |         |   |          |   |             |   |          |   |          |   |          |             |          |   |          |   |          |   |          |            |          |   |          |   |          |   |          |   |          |             |
| A           | 79B95.5   | A      | 79B95.5              | A      | 79B95.5              | A      | 79B95.5              | A | 79B94.4   |             |          |    |           |    |           |    |           |   |             |   |          |   |          |   |          |  |        |                      |  |                      |                      |                      |                      |          |                      |           |                      |           |       |           |       |             |      |           |       |          |         |          |         |          |         |          |  |          |                      |          |  |        |                      |        |                      |   |           |   |           |   |             |   |           |  |          |                      |          |                      |          |                      |          |   |        |                      |        |                      |        |                      |        |                      |  |       |   |         |   |         |   |         |   |         |   |         |   |         |   |         |   |         |   |         |   |         |   |          |   |             |   |          |   |          |   |          |             |          |   |          |   |          |   |          |            |          |   |          |   |          |   |          |   |          |             |
| B           | 79A95.5   | B      | 79A95.5              | B      | 79A95.5              | B      | 79A94.4              | B | 79A94.4   |             |          |    |           |    |           |    |           |   |             |   |          |   |          |   |          |  |        |                      |  |                      |                      |                      |                      |          |                      |           |                      |           |       |           |       |             |      |           |       |          |         |          |         |          |         |          |  |          |                      |          |  |        |                      |        |                      |   |           |   |           |   |             |   |           |  |          |                      |          |                      |          |                      |          |   |        |                      |        |                      |        |                      |        |                      |  |       |   |         |   |         |   |         |   |         |   |         |   |         |   |         |   |         |   |         |   |         |   |          |   |             |   |          |   |          |   |          |             |          |   |          |   |          |   |          |            |          |   |          |   |          |   |          |   |          |             |
| C           | 175H9160  | C      | 175H7190.22          | C      | 175H7190             | C      | 173H7100             | C | 173H7100  |             |          |    |           |    |           |    |           |   |             |   |          |   |          |   |          |  |        |                      |  |                      |                      |                      |                      |          |                      |           |                      |           |       |           |       |             |      |           |       |          |         |          |         |          |         |          |  |          |                      |          |  |        |                      |        |                      |   |           |   |           |   |             |   |           |  |          |                      |          |                      |          |                      |          |   |        |                      |        |                      |        |                      |        |                      |  |       |   |         |   |         |   |         |   |         |   |         |   |         |   |         |   |         |   |         |   |         |   |          |   |             |   |          |   |          |   |          |             |          |   |          |   |          |   |          |            |          |   |          |   |          |   |          |   |          |             |
| <b>+20°</b> |   |        |                      |        |                      |        |                      |   |           | <b>+20°</b> |          |    |           |    |           |    |           |   |             |   |          |   |          |   |          |  |        |                      |  |                      |                      |                      |                      |          |                      |           |                      |           |       |           |       |             |      |           |       |          |         |          |         |          |         |          |  |          |                      |          |  |        |                      |        |                      |   |           |   |           |   |             |   |           |  |          |                      |          |                      |          |                      |          |   |        |                      |        |                      |        |                      |        |                      |  |       |   |         |   |         |   |         |   |         |   |         |   |         |   |         |   |         |   |         |   |         |   |          |   |             |   |          |   |          |   |          |             |          |   |          |   |          |   |          |            |          |   |          |   |          |   |          |   |          |             |
| <b>+25°</b> |   |        |                      |        |                      |        |                      |   |           | <b>+25°</b> |          |    |           |    |           |    |           |   |             |   |          |   |          |   |          |  |        |                      |  |                      |                      |                      |                      |          |                      |           |                      |           |       |           |       |             |      |           |       |          |         |          |         |          |         |          |  |          |                      |          |  |        |                      |        |                      |   |           |   |           |   |             |   |           |  |          |                      |          |                      |          |                      |          |   |        |                      |        |                      |        |                      |        |                      |  |       |   |         |   |         |   |         |   |         |   |         |   |         |   |         |   |         |   |         |   |         |   |          |   |             |   |          |   |          |   |          |             |          |   |          |   |          |   |          |            |          |   |          |   |          |   |          |   |          |             |
| <b>+30°</b> |   |        |                      |        |                      |        |                      |   |           | <b>+30°</b> |          |    |           |    |           |    |           |   |             |   |          |   |          |   |          |  |        |                      |  |                      |                      |                      |                      |          |                      |           |                      |           |       |           |       |             |      |           |       |          |         |          |         |          |         |          |  |          |                      |          |  |        |                      |        |                      |   |           |   |           |   |             |   |           |  |          |                      |          |                      |          |                      |          |   |        |                      |        |                      |        |                      |        |                      |  |       |   |         |   |         |   |         |   |         |   |         |   |         |   |         |   |         |   |         |   |         |   |          |   |             |   |          |   |          |   |          |             |          |   |          |   |          |   |          |            |          |   |          |   |          |   |          |   |          |             |
| <b>+35°</b> |   |        |                      |        |                      |        |                      |   |           | <b>+35°</b> |          |    |           |    |           |    |           |   |             |   |          |   |          |   |          |  |        |                      |  |                      |                      |                      |                      |          |                      |           |                      |           |       |           |       |             |      |           |       |          |         |          |         |          |         |          |  |          |                      |          |  |        |                      |        |                      |   |           |   |           |   |             |   |           |  |          |                      |          |                      |          |                      |          |   |        |                      |        |                      |        |                      |        |                      |  |       |   |         |   |         |   |         |   |         |   |         |   |         |   |         |   |         |   |         |   |         |   |          |   |             |   |          |   |          |   |          |             |          |   |          |   |          |   |          |            |          |   |          |   |          |   |          |   |          |             |
| <b>+40°</b> |   |        |                      |        |                      |        |                      |   |           | <b>+40°</b> |          |    |           |    |           |    |           |   |             |   |          |   |          |   |          |  |        |                      |  |                      |                      |                      |                      |          |                      |           |                      |           |       |           |       |             |      |           |       |          |         |          |         |          |         |          |  |          |                      |          |  |        |                      |        |                      |   |           |   |           |   |             |   |           |  |          |                      |          |                      |          |                      |          |   |        |                      |        |                      |        |                      |        |                      |  |       |   |         |   |         |   |         |   |         |   |         |   |         |   |         |   |         |   |         |   |         |   |          |   |             |   |          |   |          |   |          |             |          |   |          |   |          |   |          |            |          |   |          |   |          |   |          |   |          |             |
| <b>+45°</b> |   |        |                      |        |                      |        |                      |   |           | <b>+45°</b> |          |    |           |    |           |    |           |   |             |   |          |   |          |   |          |  |        |                      |  |                      |                      |                      |                      |          |                      |           |                      |           |       |           |       |             |      |           |       |          |         |          |         |          |         |          |  |          |                      |          |  |        |                      |        |                      |   |           |   |           |   |             |   |           |  |          |                      |          |                      |          |                      |          |   |        |                      |        |                      |        |                      |        |                      |  |       |   |         |   |         |   |         |   |         |   |         |   |         |   |         |   |         |   |         |   |         |   |          |   |             |   |          |   |          |   |          |             |          |   |          |   |          |   |          |            |          |   |          |   |          |   |          |   |          |             |
| <b>+50°</b> |   |        |                      |        |                      |        |                      |   |           | <b>+50°</b> |          |    |           |    |           |    |           |   |             |   |          |   |          |   |          |  |        |                      |  |                      |                      |                      |                      |          |                      |           |                      |           |       |           |       |             |      |           |       |          |         |          |         |          |         |          |  |          |                      |          |  |        |                      |        |                      |   |           |   |           |   |             |   |           |  |          |                      |          |                      |          |                      |          |   |        |                      |        |                      |        |                      |        |                      |  |       |   |         |   |         |   |         |   |         |   |         |   |         |   |         |   |         |   |         |   |         |   |          |   |             |   |          |   |          |   |          |             |          |   |          |   |          |   |          |            |          |   |          |   |          |   |          |   |          |             |

\* Pri odskočenom dne alebo väčšej medzere medzi dverami sa adaptačná platnička 970.XXXX musí primerane prestaviť.

1.5 PROGRAM UHLOVÝCH ZÁVESOV

**twd**® dodávateľ kvalitných materiálov na výrobu nábytku, okien a dverí

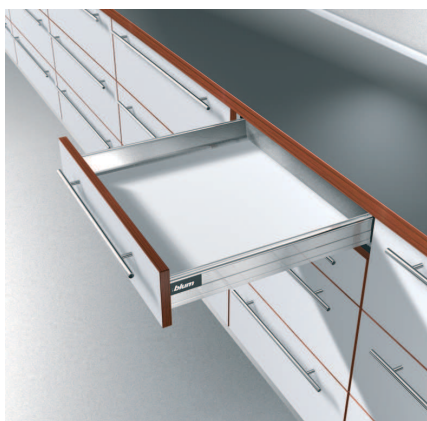
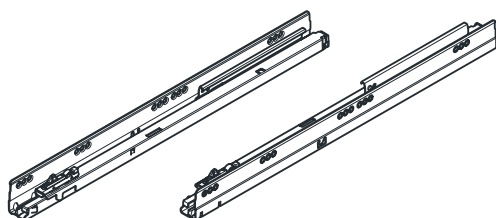
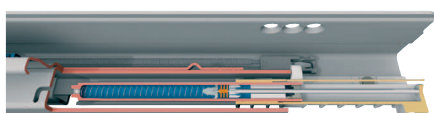
**2.1 TANDEMBOX**

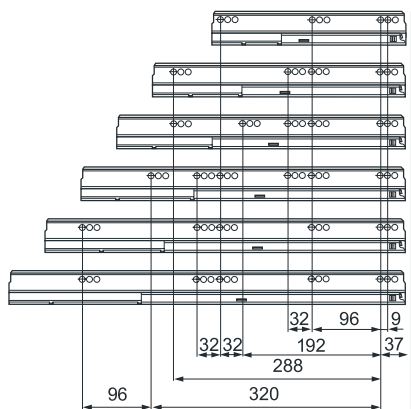
**ZÁSUVKA TANDEMBOX TYPU N**

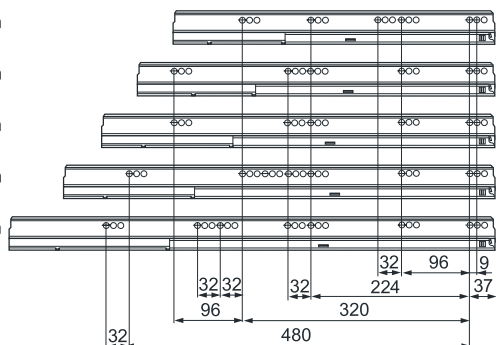
**VODIACE LIŠTY**

**VODIACA LIŠTA S INTEGROVANÝM BLUMOTION**
**Dĺžka bočnic**

 270 mm  
 350 mm  
 400 mm  
 450 mm  
 500 mm  
 550 mm

**POZÍCIE SKRUTIEK VODIACICH LIŠT S NOSNOSŤOU 30 KG**
**Dĺžka bočnic**

 450 mm  
 500 mm  
 550 mm  
 600 mm  
 650 mm

**POZÍCIE SKRUTIEK VODIACICH LIŠT S NOSNOSŤOU 50 KG**

Podrobné informácie o nábytkových výsuvoch TANDEMBOX a METABOX nájdete v špecializovanom katalógu firmy Blum, ktorý vám na vyžiadanie radi zašleme.

**VODIACE LIŠTY S BLUMOTION 1**

| Nosnosť | Dĺžka bočnic | Typ       | Obj. číslo |
|---------|--------------|-----------|------------|
| 30 kg   | 270 mm       | 558.2701B | 56-2711    |
| 30 kg   | 300 mm       | 558.3001B | 56-3011    |
| 30 kg   | 350 mm       | 558.3501B | 56-3511    |
| 30 kg   | 400 mm       | 558.4001B | 56-4011    |
| 30 kg   | 450 mm       | 558.4501B | 56-4503    |
| 30 kg   | 500 mm       | 558.5001B | 56-5003    |
| 30 kg   | 550 mm       | 558.5501B | 56-5521    |

**VODIACE LIŠTY S BLUMOTION 1**
**(PRIEMYSELNÉ BALENIE - 20 ks)**

| Nosnosť | Dĺžka bočnic | Typ       | Obj. číslo |
|---------|--------------|-----------|------------|
| 30 kg   | 350 mm       | 558.3501B | 56-3512    |
| 30 kg   | 400 mm       | 558.4001B | 56-4110    |
| 30 kg   | 450 mm       | 558.4501B | 56-5413    |
| 30 kg   | 500 mm       | 558.5001B | 56-5103    |
| 30 kg   | 550 mm       | 558.5501B | 56-5520    |

**VODIACE LIŠTY S BLUMOTION 1**

| Nosnosť | Dĺžka bočnic | Typ       | Obj. číslo |
|---------|--------------|-----------|------------|
| 50 kg   | 450 mm       | 559.4501B | 56-4512    |
| 50 kg   | 500 mm       | 559.5001B | 56-5013    |
| 50 kg   | 550 mm       | 559.5501B | 56-5513    |
| 50 kg   | 600 mm       | 559.6001B | 56-6012    |
| 50 kg   | 650 mm       | 559.6501B | 56-6512    |



**VODIACE LIŠTY S BLUMOTION 1**
**(PRIEMYSELNÉ BALENIE - 20 ks)**

| Nosnosť | Dĺžka bočnic | Typ       | Obj. číslo |
|---------|--------------|-----------|------------|
| 50 kg   | 500 mm       | 559.5001B | 56-5113    |

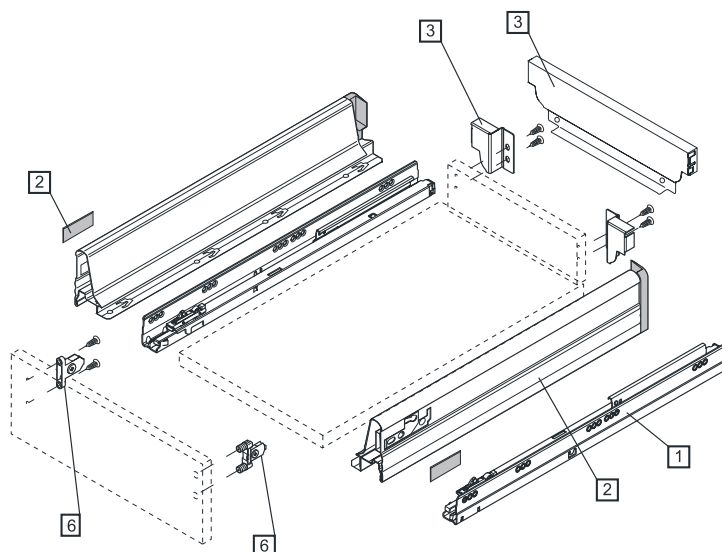

**BOČNICE** 2

| Výška bočnic | Dĺžka bočnic | Povrchová úprava | Typ       | Obj. číslo |
|--------------|--------------|------------------|-----------|------------|
| N            | 400 mm       | Biela            | 358N4002S | 56-7400    |
| N            | 400 mm       | Šedá             | 358N4002S | 56-8400    |
| N            | 450 mm       | Biela            | 358N4502S | 56-7450    |
| N            | 450 mm       | Šedá             | 358N4502S | 56-8450    |
| N            | 500 mm       | Biela            | 358N5002S | 56-7500    |
| N            | 500 mm       | Šedá             | 358N5002S | 56-8500    |
| N            | 550 mm       | Biela            | 358N5502S | 56-7550    |
| N            | 550 mm       | Šedá             | 358N5502S | 56-8550    |



ZLOŽENIE ZÁSUVKY TANDEMBOX

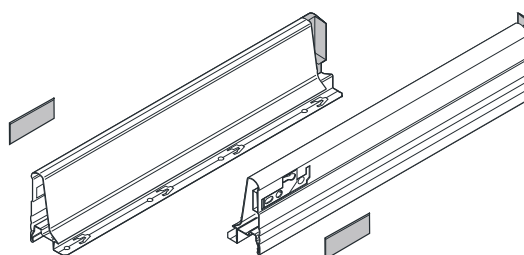

BOČNICE



**BOČNICE** 2

| Výška bočnic | Dĺžka bočnic | Povrchová úprava | Typ       | Obj. číslo |
|--------------|--------------|------------------|-----------|------------|
| M            | 270 mm       | Biela            | 358M2702S | 56-7271    |
| M            | 270 mm       | Šedá             | 358M2702S | 56-0687    |
| M            | 300 mm       | Biela            | 358M3002S | 56-7311    |
| M            | 300 mm       | Šedá             | 358M3002S | 56-8301    |
| M            | 350 mm       | Biela            | 358M3502S | 56-7351    |
| M            | 350 mm       | Šedá             | 358M3502S | 56-8351    |
| M            | 400 mm       | Biela            | 358M4002S | 56-7401    |
| M            | 400 mm       | Šedá             | 358M4002S | 56-8401    |
| M            | 450 mm       | Biela            | 358M4502S | 56-7451    |
| M            | 450 mm       | Šedá             | 358M4502S | 56-8451    |
| M            | 500 mm       | Biela            | 358M5002S | 56-7501    |
| M            | 500 mm       | Šedá             | 358M5002S | 56-8501    |
| M            | 550 mm       | Biela            | 358M5502S | 56-7551    |
| M            | 550 mm       | Šedá             | 358M5502S | 56-8551    |
| M            | 600 mm       | Biela            | 359M6002S | 56-7601    |
| M            | 600 mm       | Šedá             | 359M6002S | 56-8601    |
| M            | 650 mm       | Biela            | 359M6502S | 56-7651    |
| M            | 650 mm       | Šedá             | 359M6502S | 56-8651    |



ZÁSUVKA TANDEMBOX TYPU M

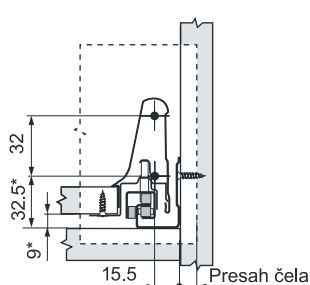

Rozmery na montáž čela  
pre TANDEMBOX typu N

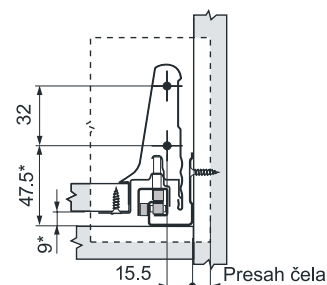

Rozmery na montáž čela  
pre TANDEMBOX typu M

VÝSUVY ZÁSUVKOVÉ

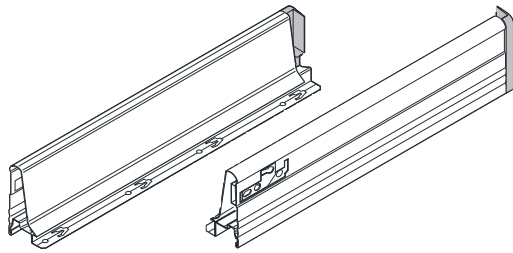

BOČNICE

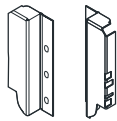
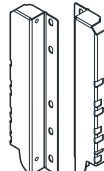
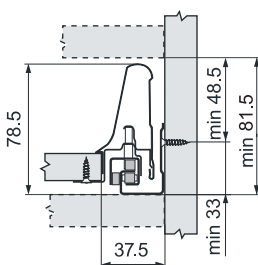
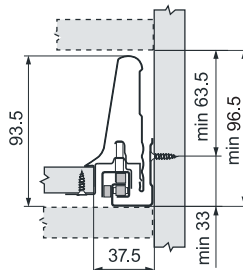
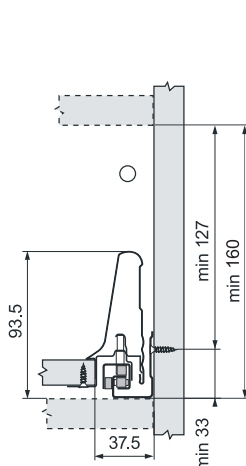
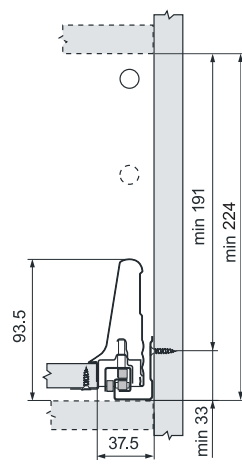
DRŽIAK CHRBT  
TYP NDRŽIAK CHRBT  
TYP MDRŽIAK CHRBT  
TYP BDRŽIAK CHRBT  
TYP DMinimálna svetlá výška zásuvky  
TANDEMBOX typu NMinimálna svetlá výška zásuvky  
TANDEMBOX typu MMinimálna svetlá výška zásuvky  
TANDEMBOX typu BMinimálna svetlá výška zásuvky  
TANDEMBOX typu D

UPEVNENIE ČELA

BOČNICE <sup>2</sup> (PRIEMYSELNÉ BALENIE - 20 ks)

| Výška bočnic | Dĺžka bočnic | Povrchová úprava | Typ       | Obj. číslo |
|--------------|--------------|------------------|-----------|------------|
| M            | 350 mm       | Šedá             | 358M3502S | 56-8352    |
| M            | 400 mm       | Šedá             | 358M4002S | 56-8411    |
| M            | 450 mm       | Biela            | 358M4502S | 56-7452    |
| M            | 450 mm       | Šedá             | 358M4502S | 56-8452    |
| M            | 500 mm       | Biela            | 358M5002S | 56-7511    |
| M            | 500 mm       | Šedá             | 358M5002S | 56-8511    |
| M            | 550 mm       | Šedá             | 358M5502S | 56-8552    |

\* krytky nie sú súčasťou balenia

KRYTKA <sup>2</sup> K BOČNICI\* (bez potlače\*\*)

| Typ      | Povrchová úprava | Obj. číslo |
|----------|------------------|------------|
| ZAA.330C | Šedá             | 56-0680    |

\*Potrebná len k priemyselnému baleniu

\*\*Možnosť individuálnej potlače: ☎ twd-dispečing

DRŽIAK CHRBT <sup>3</sup>

| Typ držiaku | Povrchová úprava | Typ      | Obj. číslo |
|-------------|------------------|----------|------------|
| N           | Biela            | Z30N000S | 56-0592    |
| N           | Šedá             | Z30N000S | 56-1592    |
| M           | Biela            | Z30M000S | 56-0162    |
| M           | Šedá             | Z30M000S | 56-1162    |
| B           | Biela            | Z30B000S | 56-7030    |
| B           | Šedá             | Z30B000S | 56-8030    |
| D           | Biela            | Z30D000S | 56-7032    |
| D           | Šedá             | Z30D000S | 56-8032    |

UPEVNENIE ČELA <sup>6</sup>

| Verzia       | Typ      | Obj. číslo |
|--------------|----------|------------|
| Na skrutky   | ZSF.3502 | 56-0163    |
| Na hmoždinky | ZSF.3902 | 56-0210    |

**RELING POZDĽŽNY\***



| Dĺžka bočnic | Povrchová úprava | Typ         | Obj. číslo |
|--------------|------------------|-------------|------------|
| 350 mm       | Biela            | ZRG.296V.IC | 56-7296    |
| 350 mm       | Šedá             | ZRG.296V.IC | 56-8296    |
| 400 mm       | Biela            | ZRG.346V.IC | 56-7346    |
| 400 mm       | Šedá             | ZRG.346V.IC | 56-8346    |
| 450 mm       | Biela            | ZRG.396V.IC | 56-7396    |
| 450 mm       | Šedá             | ZRG.396V.IC | 56-8396    |
| 500 mm       | Biela            | ZRG.446V.IC | 56-7446    |
| 500 mm       | Šedá             | ZRG.446V.IC | 56-8446    |
| 550 mm       | Biela            | ZRG.496V.IC | 56-7496    |
| 550 mm       | Šedá             | ZRG.496V.IC | 56-8496    |
| 600 mm       | Šedá             | ZRG.546V.IC | 56-8546    |
| 650 mm       | Biela            | ZRG.596V.IC | 56-7596    |
| 650 mm       | Šedá             | ZRG.596V.IC | 56-8596    |

\*Predávaný na ks, k výsuvu sú potrebné 2 ks

**ÚCHYTKA RELINGU\***



| Typ       | Povrchová úprava | Obj. číslo |
|-----------|------------------|------------|
| ZRG.000E3 | Šedá             | 56-0682    |

\*Slúži na upevnenie stredového relingu pri výške D



TANDEMBOX S POZDĽŽNYM RELINGOM

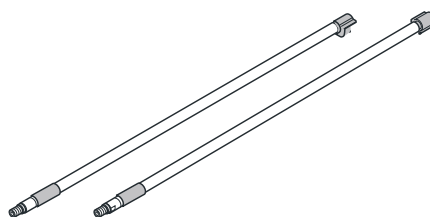

POZDĽŽNY RELING

**VNÚTORNÁ ZÁSUVKA - UPEVNENIE ČELA**



| Typ držiaku | Typ      | Obj. číslo |
|-------------|----------|------------|
| M           | ZIF.70M0 | 56-7010    |
| B           | ZIF.72B0 | 56-7210    |
| D           | ZIF.73D0 | 56-7310    |
| C           | ZIF.72C0 | 56-7410    |



VNÚTORNÁ ZÁSUVKA

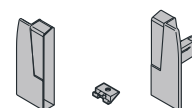

UPEVNENIE ČELA

**VNÚTORNÁ ZÁSUVKA - PREDNÝ DIEL (na skrátenie)**



| Dĺžka   | Povrchová úprava | Typ       | Obj. číslo |
|---------|------------------|-----------|------------|
| 1081 mm | Biela            | Z31A1081A | 56-3270    |
| 1081 mm | Šedá             | Z31A1081A | 56-2270    |
| 1081 mm | Nerez            | Z31A1081A | 56-1270    |

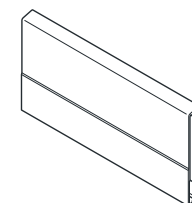

PREDNÝ DIEL

**VNÚTORNÁ ZÁSUVKA - ÚCHYTKA**

| Typ                            | Obj. číslo |
|--------------------------------|------------|
| ZIF.7008                       | 56-0564    |
| ZIF.7007 s voliteľným unášačom | 56-0698    |



ÚCHYTKA ZIF.7007

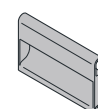

ÚCHYTKA ZIF.7008



RELINGOVÁ TYČ ZRG.1104U



BOXSIDE

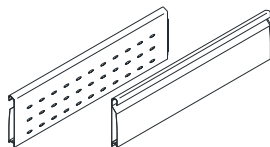

BOXSIDE

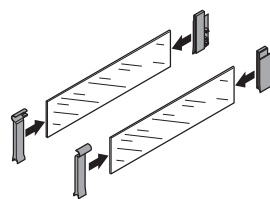
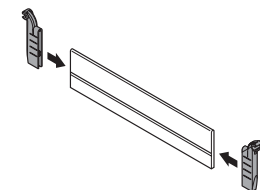

SKLENENÝ BOXSIDE

KONCOVKY NA  
SKLENENÝ BOXSIDE

KONCOVKY NA PRIEČKY

## RELINGOVÁ TYČ (na skrátenie)



| Dĺžka   | Povrchová úprava | Typ       | Obj. číslo |
|---------|------------------|-----------|------------|
| 1104 mm | Šedá             | ZRG.1104U | 56-0414    |
| 1104 mm | Biela            | ZRG.1104U | 56-0185    |

## ZVÝŠENIE ZÁSUVKY - BOXSIDE



| Dĺžka bočnic | Povrchová úprava | Typ        | Obj. číslo |
|--------------|------------------|------------|------------|
| 450 mm       | Biela            | Z37H418S.E | 56-7418    |
| 450 mm       | Šedá             | Z37H418S.E | 56-8418    |
| 500 mm       | Biela            | Z37H468S.E | 56-7468    |
| 500 mm       | Šedá             | Z37H468S.E | 56-8468    |
| 550 mm       | Biela            | Z37H518S.E | 56-7518    |
| 550 mm       | Šedá             | Z37H518S.E | 56-8518    |
| 600 mm       | Šedá             | Z37H568S   | 56-8568    |
| 650 mm       | Biela            | Z37H618S.E | 56-7618    |
| 650 mm       | Šedá             | Z37H618S.E | 56-8618    |

## SKLENENÝ BOXSIDE - KONCOVKY

| Typ         | Obj. číslo |
|-------------|------------|
| Z36H000G.02 | 56-0700    |

## KONCOVKY NA PRIEČKY

| Typ        | Obj. číslo  |
|------------|-------------|
| Z40H0002.R | 71-55491519 |

**2.2 TANDEMBOX INTIVO**

ZÁSUVKA TANDEMBOX INTIVO HODVÁBNA BIELA S BOXCAP



ZÁSUVKA TANDEMBOX INTIVO ČIERNA TERRA S BOXCAP

BOČNICE <sup>2a</sup>

| Výška bočnic | Dĺžka bočnic | Povrchová úprava | Typ        | Obj. číslo |
|--------------|--------------|------------------|------------|------------|
| M            | 270 mm       | Hodvábná biela   | 358M2702SA | 56-8439    |
| M            | 300 mm       | Čierna Terra     | 358M3002SA | 56-7193    |
| M            | 300 mm       | Hodvábná biela   | 358M3002SA | 56-9195    |
| M            | 350 mm       | Hodvábná biela   | 358M3502SA | 56-0752    |
| M            | 350 mm       | Čierna Terra     | 358M3502SA | 56-0374    |
| M            | 400 mm       | Hodvábná biela   | 358M4002SA | 56-0042    |
| M            | 450 mm       | Hodvábná biela   | 358M4502SA | 56-3073    |
| M            | 450 mm       | Čierna Terra     | 358M4502SA | 56-3074    |
| M            | 500 mm       | Hodvábná biela   | 358M5002SA | 56-3212    |
| M            | 500 mm       | Čierna Terra     | 358M5002SA | 56-8443    |
| M            | 550 mm       | Čierna Terra     | 358M5502SA | 56-0368    |
| M            | 600 mm       | Hodvábná biela   | 359M6002SA | 56-7301    |
| M            | 650 mm       | Hodvábná biela   | 359M6502SA | 56-8449    |
| M            | 650 mm       | Čierna Terra     | 359M6502SA | 56-8445    |

**BOČNICE** 2a



| Výška bočnic | Dĺžka bočnic | Povrchová úprava | Typ          | Obj. číslo |
|--------------|--------------|------------------|--------------|------------|
| L            | 270 mm       | Hodvábná biela   | 358L2702SA2  | 56-8440    |
| L            | 300 mm       | Hodvábná biela   | 358L3002SA2  | 56-7199    |
| L            | 300 mm       | Čierna Terra     | 358L3002SA2  | 56-7195    |
| L            | 350 mm       | Hodvábná biela   | 358L3502SA2  | 56-8442    |
| L            | 400 mm       | Hodvábná biela   | 358L4002SA2Z | 56-8441    |
| L            | 450 mm       | Hodvábná biela   | 358L4502SA2Z | 56-2082    |
| L            | 450 mm       | Čierna Terra     | 358L4502SA2Z | 56-2084    |
| L            | 500 mm       | Hodvábná biela   | 358L5002SA2Z | 56-2152    |
| L            | 500 mm       | Čierna Terra     | 358L5002SA2Z | 56-2154    |
| L            | 550 mm       | Čierna Terra     | 358L5502SA2Z | 56-0366    |
| L            | 600 mm       | Hodvábná biela   | 359L6002SAZ  | 56-3029    |
| L            | 650 mm       | Hodvábná biela   | 359L6502SAZ  | 56-3028    |
| L            | 650 mm       | Čierna Terra     | 359L6502SAZ  | 56-8444    |

**BOČNICE** 2a (PRIEMYSELNÉ BALENIE - 20 ks)



| Výška bočnic | Dĺžka bočnic | Povrchová úprava | Typ          | Obj. číslo |
|--------------|--------------|------------------|--------------|------------|
| M            | 500 mm       | Hodvábná biela   | 358M5002SA   | 56-2153    |
| L            | 500 mm       | Hodvábná biela   | 358L5002SA2Z | 56-2151    |

**KRYTKA K BOČNICI** 2b (bez potlače\*)



| Typ      | Povrchová úprava | Obj. číslo |
|----------|------------------|------------|
| ZAA.532C | Hodvábná biela   | 56-7266    |

\*Možnosť individuálnej potlače: ☎ twd-dispečing

**DRŽIAK CHRBTÁ** 3



| Typ držiaku | Povrchová úprava | Typ         | Obj. číslo |
|-------------|------------------|-------------|------------|
| M           | Hodvábná biela   | Z30M000S.04 | 56-4799    |
| M           | Čierna Terra     | Z30M000S.04 | 56-9434    |
| D           | Hodvábná biela   | Z30D000SL   | 56-9082    |
| D           | Čierna Terra     | Z30D000SL   | 56-9084    |

**UPEVNENIE ČELA** 4



| Verzia                          | Typ      | Obj. číslo |
|---------------------------------|----------|------------|
| Na skrutky                      | ZSF.3502 | 56-0163    |
| Na hmoždinky                    | ZSF.3902 | 56-0210    |
| Na skrutky (pre bočnice typu L) | ZSF.5220 | 56-7976    |



ZÁSUVKA TANDEMBOX INTIVO NEREZ S BOXCAP

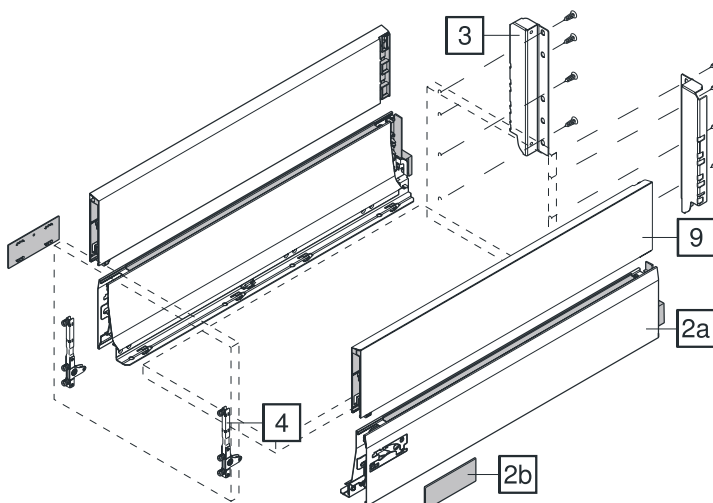

ZLOŽENIE ZÁSUVKY TANDEMBOX INTIVO S BOXCAP

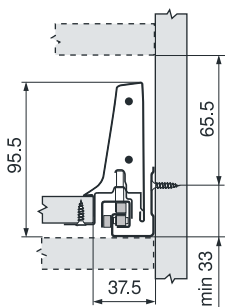

Minimálna svetlá výška zásuvky TANDEMBOX INTIVO typu M

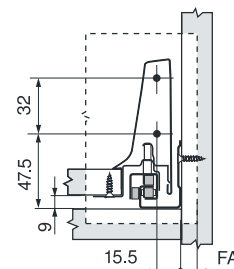

Rozmery na montáž čela pre TANDEMBOX INTIVO typu M (FA - presah čela)

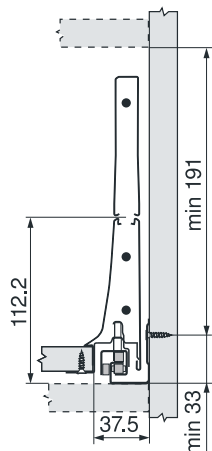

Minimálna svetlá výška zásuvky TANDEMBOX INTIVO typu L

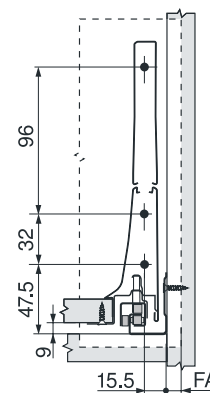

Rozmery na montáž čela pre TANDEMBOX INTIVO typu L (FA - presah čela)

VÝSUVY ZÁSUVKOVÉ

 ZÁSUVKA TANDEMBOX INTIVO  
HODVÁBNA BIELA S BOXCOVER

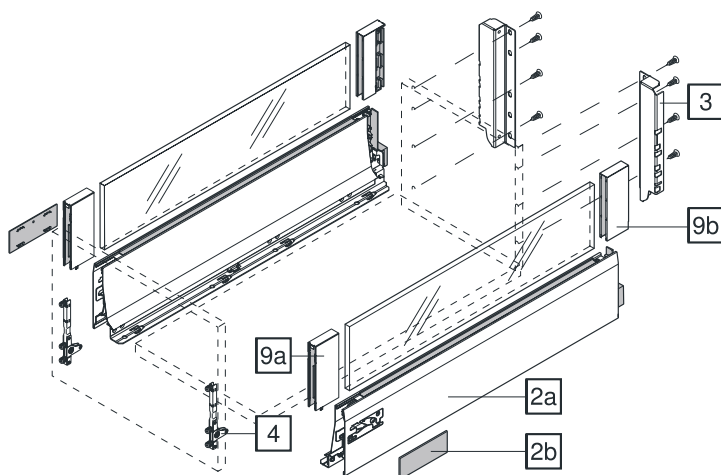
 ZÁSUVKA TANDEMBOX INTIVO  
ČIERNA TERRA S BOXCOVER

ZLOŽENIE ZÁSUVKY TANDEMBOX INTIVO S BOXCOVER

### 2.3 TANDEMBOX SPACE CORNER

 ZÁSUVKA TANDEMBOX SPACE CORNER  
SO SYNCROMOTION

#### ZVÝŠENIE ZÁSUVKY - BOXCAP 9



| Dĺžka bočnic | Povrchová úprava | Typ        | Obj. číslo |
|--------------|------------------|------------|------------|
| 300 mm       | Čierna Terra     | Z37L290S.D | 56-7197    |
| 350 mm       | Hodvábna biela   | Z37L340S.D | 56-8493    |
| 400 mm       | Hodvábna biela   | Z37L390S.D | 56-8410    |
| 450 mm       | Hodvábna biela   | Z37L440S.D | 56-0049    |
| 450 mm       | Čierna Terra     | Z37L440S.D | 56-3927    |
| 500 mm       | Hodvábna biela   | Z37L490S.D | 56-8272    |
| 500 mm       | Čierna Terra     | Z37L490S.D | 56-8478    |
| 550 mm       | Čierna Terra     | Z37L540S.D | 56-0369    |
| 600 mm       | Hodvábna biela   | Z37L590S.D | 56-3033    |
| 650 mm       | Hodvábna biela   | Z37L640S.D | 56-3030    |

#### UPÍNACÍ PROFIL



| Dĺžka bočnic | Povrchová úprava | Typ      | Obj. číslo |
|--------------|------------------|----------|------------|
| 500 mm       | Hodvábna biela   | Z49L472S | 56-7978    |
| 500 mm       | Čierna Terra     | Z49L472S | 56-7194    |
| 600 mm       | Hodvábna biela   | Z49L572S | 56-3034    |
| 650 mm       | Hodvábna biela   | Z49L622S | 56-7304    |

#### ZVÝŠENIE ZÁSUVKY - BOXCOVER 9a 9b



| Typ        | Povrchová úprava | Obj. číslo |
|------------|------------------|------------|
| Z36L002G.S | Hodvábna biela   | 56-4272    |
| Z36L002G.S | Čierna Terra     | 56-4274    |

\* Výplň twd nedodáva.

VODIACE LIŠTY 1, BOČNICE 2, RELINGY a BOXSIDE s dĺžkou 600 mm, 650 mm nájdete v kapitole 2.1 TANDEMBOX.

Optimálny rozmer skrinky SPACE CORNER je 1050 x 1050 mm.

#### SÚPRAVA SYNCROMOTION 4a až 4g



| Typ       | Povrchová úprava | Obj. číslo |
|-----------|------------------|------------|
| Z33M00A06 | Sivá RAL 7037    | 56-0689    |
| Z33D00A06 | Sivá RAL 7037    | 56-0690    |



**DRŽIAK CHRBTÁ** 3



| Typ držiaku | Povrchová úprava | Typ       | Obj. číslo |
|-------------|------------------|-----------|------------|
| M pravý     | Sivá             | Z30MOS.45 | 56-5162    |
| M ľavý      | Sivá             | Z30MOS.45 | 56-6162    |
| D pravý     | Sivá             | Z30DOS.45 | 56-9132    |
| D ľavý      | Sivá             | Z30DOS.45 | 56-8132    |

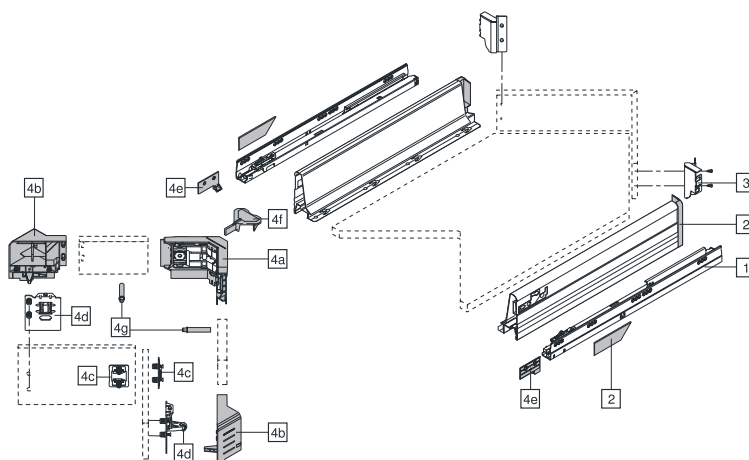

ZLOŽENIE ZÁSUVKY TANDEMBOX SPACE CORNER SO SYNCROMOTION

**2.4 PRÍSLUŠENSTVO PRE TANDEMBOX**



**SERVODRIVE** – elektrická podpora otvárania zásuvky\*

| Názov   | Typ         | Obj. číslo |
|---|-------------|------------|
| Dištančný doraz (8 mm)                                  | 993.0830.01 | 56-7402    |
| SERVO-DRIVE servo (pohonná) jednotka                    | Z10A3000    | 56-7597    |
| Držiak nosníka horný + spodný, vlys na plocho           | Z10D01E0    | 56-7549    |
| Držiak na jednu servo jednotku s káblom                 | Z10D7101    | 56-7206    |
| Držiak na dve servo jednotky s káblom                   | Z10D7201    | 56-7211    |
| Držiak káblov s lepiacou fóliou                         | Z10K0009    | 56-7109    |
| Synchronizačný kábel viacžilový, dĺžka: 8 cm            | Z10K008S    | 56-7008    |
| Synchronizačný kábel viacžilový, dĺžka: 120 cm          | Z10K120S    | 56-7009    |
| Elektrický kábel, dĺžka: 8 m + 5 ks káblových koncoviek | Z10K800AE   | 56-7552    |
| Napájací kábel Európa, so zástrčkou, dĺžka: 2 m         | Z10M200E    | 56-7205    |
| Transformátor   | Z10NE050    | 56-7201    |
| Nosič transformátora pre montáž do dna                  | Z10NG000    | 56-7282    |
| Nosič transformátora pre montáž na stenu                | Z10NG100    | 56-7283    |
| Svorka s káblovou koncovkou                             | Z10V100E    | 56-7554    |
| SERVO-DRIVE nosník, dĺžka: 750 mm, kábel vložený        | Z10T750AA   | 56-7467    |

\* Technické riešenie: ☎ twd-dispečing



SERVODRIVE

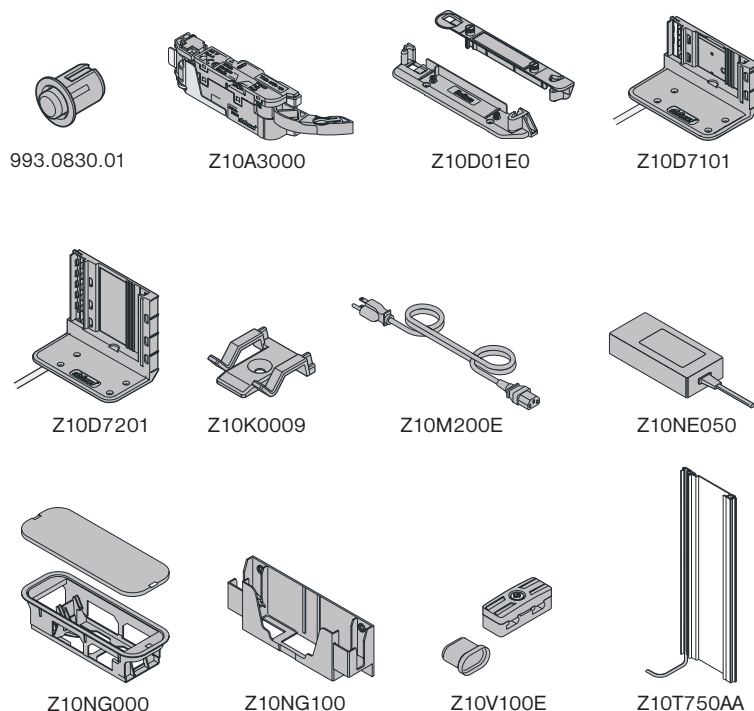

**VÝSUVY ZÁSUVKOVÉ**



ZÁSUVKA TANDEMBOX S TIP-ON

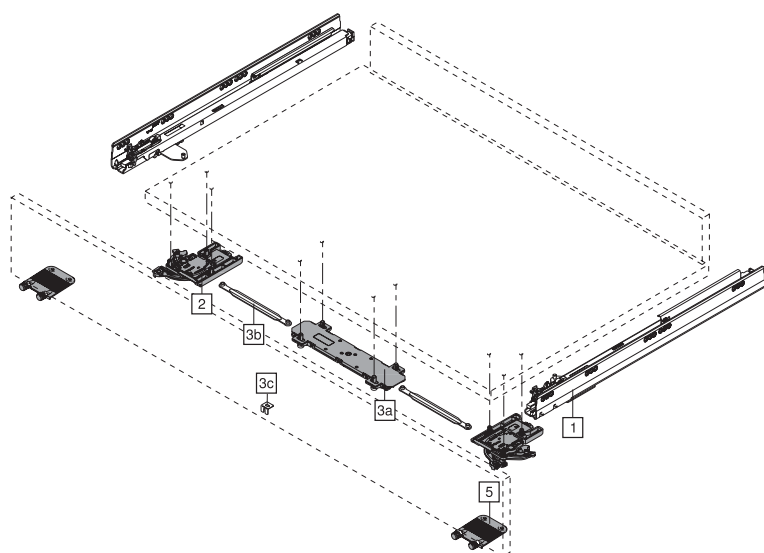

ZLOŽENIE ZÁSUVKY TANDEMBOX S TIP-ON

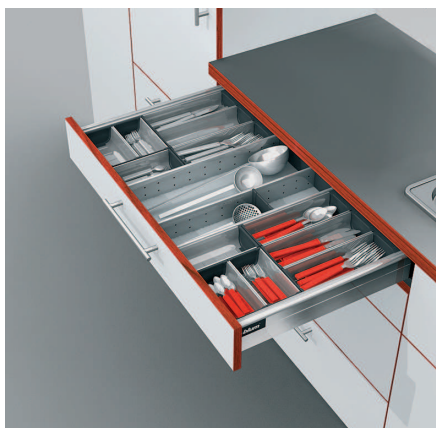

ORGA-LINE NA PRÍBORY

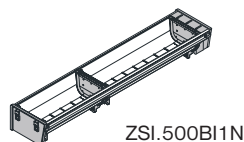

ZSI.500BI1N

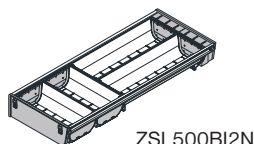

ZSI.500BI2N

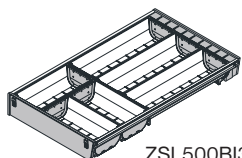

ZSI.500BI3

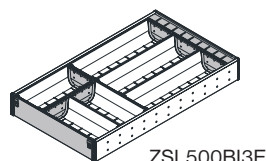

ZSI.500BI3E

**TIP-ON VODIACE LIŠTY S ARETÁCIOU** 1 + 2

| Nosnosť | Dĺžka bočnic | Typ       | Obj. číslo |
|---------|--------------|-----------|------------|
| 20 kg   | 270 mm       | 559.2701T | 56-3711    |
| 20 kg   | 300 mm       | 559.3001T | 56-3016    |
| 30 kg   | 350 mm       | 559.3501T | 56-3513    |
| 30 kg   | 400 mm       | 559.4001T | 56-4012    |
| 50 kg   | 450 mm       | 559.4501T | 56-4513    |
| 50 kg   | 500 mm       | 559.5001T | 56-5213    |
| 30 kg   | 550 mm       | 559.5501T | 56-5514    |

**TIP-ON SYNCHRONIZÁCIA** 3a + 3b + 3c

| Použitie pre svetlú šírku korpusu LW | Typ       | Obj. číslo |
|--------------------------------------|-----------|------------|
| 508 - 570 mm                         | Z55S1350E | 56-0633    |
| 558 - 620 mm                         | Z55S1600E | 56-0636    |
| 658 - 720 mm                         | Z55S2100E | 56-0645    |
| 708 - 770 mm                         | Z55S2350E | 56-0634    |
| 758 - 820 mm                         | Z55S2600E | 56-2904    |
| 808 - 870 mm                         | Z55S2850E | 56-0635    |
| 858 - 920 mm                         | Z55S3100E | 56-0638    |
| 958 - 1020 mm                        | Z55S3600E | 56-0637    |
| 1008 - 1070 mm                       | Z55S3850E | 56-0643    |
| 1058 - 1120 mm                       | Z55S4100E | 56-0644    |
| 1108 - 1170mm                        | Z55S4350E | 56-0640    |

\* Použitie: voliteľne od šírky korpusu 550 mm

**TIP-ON STABILIZÁCIA ČELA** 5

| Typ      | Obj. číslo |
|----------|------------|
| Z96.10E1 | 56-1046    |

**ORGA-LINE NA PRÍBORY**

| Šírka korpusu  | ZSI.500BI1N<br>Obj.č.: 56-0457 | ZSI.500BI2N<br>Obj.č.: 56-0730 | ZSI.500BI3<br>Obj.č.: 56-0458 | ZSI.500FI2N<br>Obj.č.: 56-0518 | ZSI.500KI4<br>Obj.č.: 56-0604 | ZSI.500BI3E<br>Obj.č.: 56-0633 |
|----------------|--------------------------------|--------------------------------|-------------------------------|--------------------------------|-------------------------------|--------------------------------|
| do 300 mm      | 1 x                            |                                |                               |                                |                               |                                |
| do 400 mm      | 2 x                            |                                |                               |                                |                               |                                |
| do 450 mm      |                                |                                | 1 x                           |                                |                               |                                |
| do 550 mm      | 1 x                            | 1 x                            |                               |                                |                               |                                |
| do 800 mm      | 1 x                            |                                | 1 x                           |                                |                               |                                |
| do 900 mm      |                                |                                | 2 x                           |                                |                               |                                |
| do 1000 mm     |                                |                                | 1 x                           |                                | 1 x                           |                                |
| do 1200 mm     |                                |                                |                               |                                | 2 x                           |                                |
| nad 1200 mm    |                                |                                | 1 x                           | 1 x                            | 1 x                           |                                |
| rohová zásuvka |                                |                                |                               |                                |                               | 1 x                            |

**ORGA-LINE NA DROBNÉ PREDMETY**



| Šírka korpusu  | ZSI.500BI1N<br>Obj.č. 56-0457 | ZSI.500FI2N<br>Obj.č. 56-0518 | ZSI.500KI2N<br>Obj.č. 56-0605 | ZSI.500MI3<br>Obj.č. 56-0603 | ZSI.500MI3E<br>Obj.č. 56-0632 |
|----------------|-------------------------------|-------------------------------|-------------------------------|------------------------------|-------------------------------|
| do 450 mm      | 1 x                           |                               |                               |                              |                               |
| do 600 mm      |                               |                               |                               | 1 x                          |                               |
| do 800 mm      | 1 x                           |                               |                               | 1 x                          |                               |
| do 900 mm      |                               |                               |                               | 2 x                          |                               |
| do 1000 mm     | 1 x                           | 1 x                           |                               | 1 x                          |                               |
| nad 1000 mm    |                               | 1 x                           | 1 x                           | 1 x                          |                               |
| rohová zásuvka |                               |                               |                               |                              | 1 x                           |

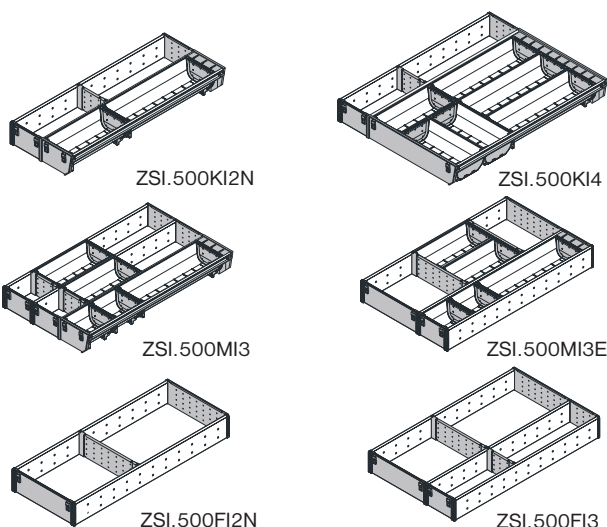

**ORGA-LINE NA ČISTIACE PROSTRIEDKY**



| Šírka korpusu | ZSI.500BI1N<br>Obj.č. 56-0457 | ZSI.500FI2N<br>Obj.č. 56-0518 | ZSI.500FI3<br>Obj.č. 56-0517 | ZSI.500KI2N<br>Obj.č. 56-0605 | ZSI.500KI3N<br>Obj.č. 56-0631 |
|---------------|-------------------------------|-------------------------------|------------------------------|-------------------------------|-------------------------------|
| do 800 mm     | 1 x                           |                               |                              |                               | 1 x                           |
| do 900 mm     |                               |                               |                              |                               | 2 x                           |
| do 1000 mm    | 1 x                           | 1 x                           |                              |                               | 1 x                           |
| do 1200 mm    |                               | 1 x                           |                              | 1 x                           | 1 x                           |
| nad 1200 mm   |                               |                               | 1 x                          |                               | 2 x                           |



ORGA-LINE NA ČISTIACE PROSTRIEDKY

**ORGA-LINE NA PRACOVNÉ PRÍBORY A SPOTREBIČE**



| Šírka korpusu  | ZSI.500BI1N<br>Obj.č. 56-0457 | ZSI.500FI2N<br>Obj.č. 56-0518 | ZSI.500FI3<br>Obj.č. 56-0517 | ZSI.500KI2N<br>Obj.č. 56-0605 | ZSI.500KI3N<br>Obj.č. 56-0631 | ZSZ.02MO<br>Obj.č. 56-0683 |
|----------------|-------------------------------|-------------------------------|------------------------------|-------------------------------|-------------------------------|----------------------------|
| do 450 mm      | 1 x                           |                               |                              |                               |                               |                            |
| do 600 mm      |                               | 1 x                           |                              |                               |                               | 1 x                        |
| do 800 mm      | 1 x                           |                               |                              |                               | 1 x                           | 1 x                        |
| do 900 mm      |                               |                               |                              |                               | 2 x                           | 1 x                        |
| do 1000 mm     | 1 x                           | 1 x                           |                              |                               | 1 x                           | 1 x                        |
| do 1200 mm     |                               | 1 x                           |                              | 1 x                           | 1 x                           | 1 x                        |
| nad 1200 mm    |                               |                               | 1 x                          |                               | 2 x                           | 1 x                        |
| rohová zásuvka |                               |                               | 1 x                          |                               |                               | 1 x                        |

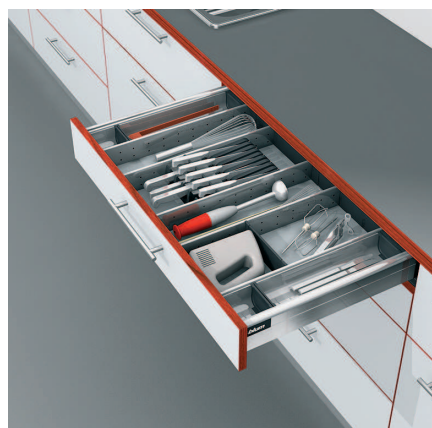

ORGA-LINE NA PRACOVNÉ PRÍBORY A SPOTREBIČE

**ORGA-LINE NA PRACOVNÉ PRÍBORY NA VARENIE**



| Šírka korpusu | ZSI.500BI1N<br>Obj.č. 56-0457 | ZSI.500FI2N<br>Obj.č. 56-0518 | ZSI.500FI3<br>Obj.č. 56-0517 | ZSI.500KI2N<br>Obj.č. 56-0605 | ZSI.500KI3N<br>Obj.č. 56-0631 |
|---------------|-------------------------------|-------------------------------|------------------------------|-------------------------------|-------------------------------|
| do 800 mm     | 1 x                           |                               |                              |                               | 1 x                           |
| do 900 mm     |                               |                               |                              |                               | 2 x                           |
| do 1000 mm    | 1 x                           | 1 x                           |                              |                               | 1 x                           |
| do 1200 mm    |                               | 1 x                           |                              | 1 x                           | 1 x                           |
| nad 1200 mm   |                               |                               | 1 x                          |                               | 2 x                           |



ORGA-LINE NA PRACOVNÉ PRÍBORY NA VARENIE

# VÝSUVY ZÁSUVKOVÉ

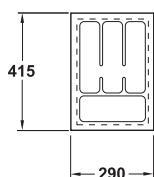
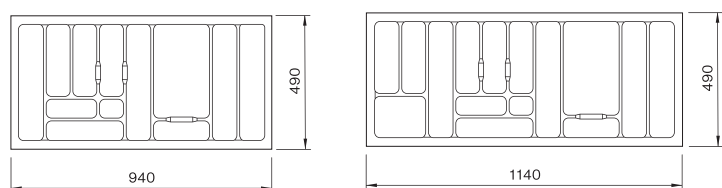
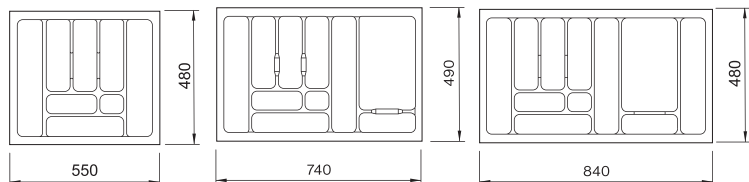
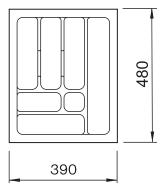

ORGA-LINE NA TANIERE

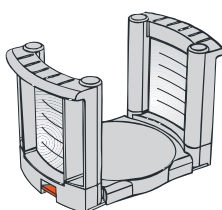

ORGA-LINE NA KORENIČKY

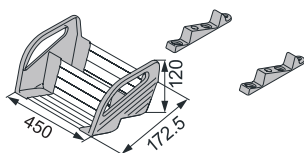

PRIAZNIVÁ  
CENA

## PRÍBORNÍKOVÉ VÝLISKY PLASTOVÉ T-LINE

| Šírka   | Hĺbka  | Povrchová úprava | Obj. číslo  |
|---------|--------|------------------|-------------|
| 390 mm  | 480 mm | Šedá             | 24-41101001 |
| 450 mm  | 480 mm | Šedá             | 24-41109001 |
| 550 mm  | 480 mm | Šedá             | 24-41110001 |
| 740 mm  | 490 mm | Šedá             | 80-2122     |
| 840 mm  | 480 mm | Šedá             | 24-41108001 |
| 940 mm  | 490 mm | Šedá             | 80-2215     |
| 1140 mm | 490 mm | Šedá             | 80-2216     |

TOP  
KVALITA

## ORGA-LINE NA TANIERE

| Výška držiaka | Priemer tanierov | Typ      | Obj. číslo |
|---------------|------------------|----------|------------|
| 171 mm        | 180 - 320 mm     | ZTH.0350 | 56-0492    |

TOP  
KVALITA

## ORGA-LINE NA KORENIČKY

| Šírka korpusu | Typ       | Obj. číslo |
|---------------|-----------|------------|
| 450 mm        | ZFZ.45G01 | 56-0678    |



**ORGA-LINE NA NOŽE**

| Typ      | Obj. číslo |
|----------|------------|
| ZSZ.02M0 | 56-0683    |

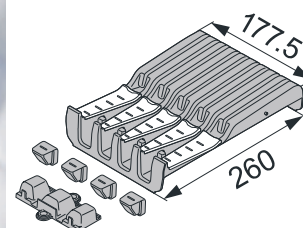

ORGA-LINE NA NOŽE



**ORGA-LINE - REZAČKA NA POTRAVINÁRSKU FÓLIU**

| Typ      | Obj. číslo |
|----------|------------|
| ZSZ.01F0 | 56-9068    |



ORGA-LINE - REZAČKA NA POTRAVINÁRSKU FÓLIU

**ORGA-LINE - REZAČKA NA ALU FÓLIU**

| Typ      | Obj. číslo |
|----------|------------|
| ZSZ.02FO | 56-0493    |



**POMOCNÍK DO KUCHYNE (SÚPRAVA ORGA-LINE)\***

| Typ       | Obj. číslo |
|-----------|------------|
| ZOU.30U11 | 56-9411    |

\*Súprava obsahuje: držiak na tanieru (2x), zásobník na koreníčky vrátane koreníčiek (1x), úložný priestor na kuchynské nože (1x), zásobník potravinovej fólie s rezacím nožom (1x) a zásobník hliníkovej fólie s rezacím nožom (1x).



Informácie o ďalších doplnkoch ORGA-LINE: ☎ twd-dispečing

VÝSUVY ZÁSUVKOVÉ

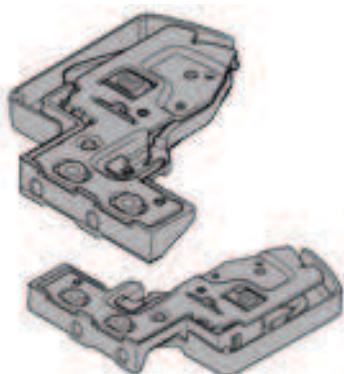
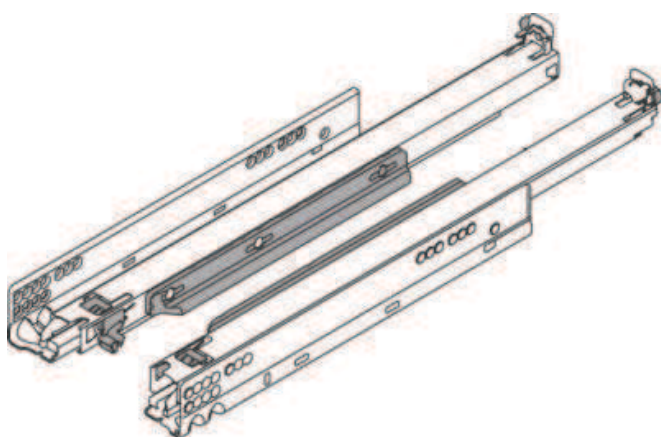
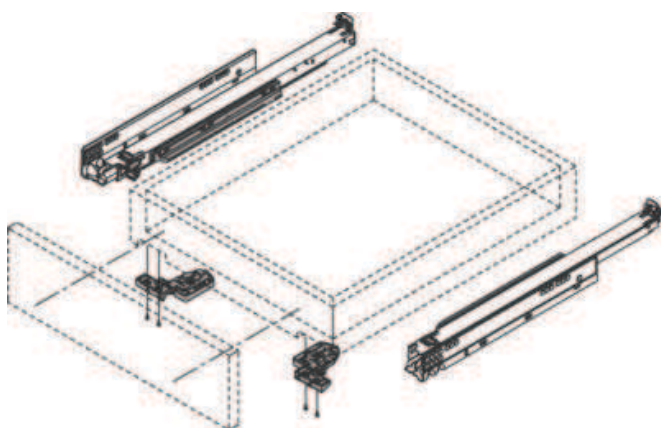
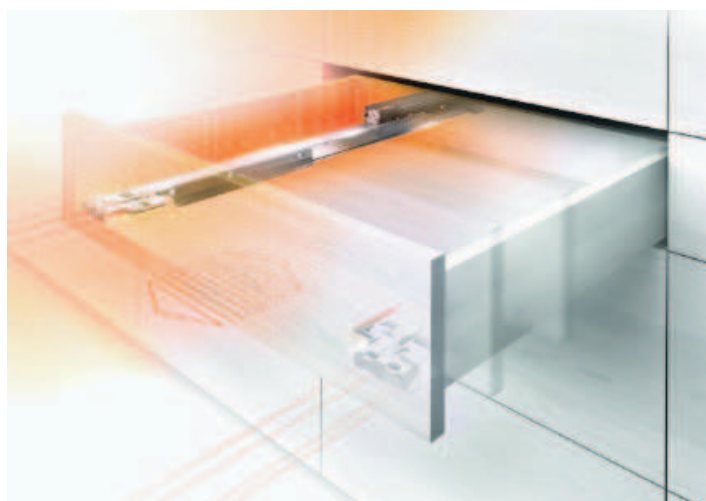
**2.5 MOVENTO**

**VODIACE LIŠTY**

| Nosnosť | Dĺžka  | Typ       | Obj. číslo |
|---------|--------|-----------|------------|
| 40 kg   | 300 mm | 760H3000B | 56-3316    |
| 40 kg   | 350 mm | 760H3500B | 56-3736    |
| 40 kg   | 400 mm | 760H4000B | 56-5811    |
| 40 kg   | 450 mm | 760H4500B | 56-3118    |
| 40 kg   | 500 mm | 760H5000B | 56-4943    |
| 60 kg   | 450 mm | 766H4500B | 56-1929    |
| 60 kg   | 500 mm | 766H5000B | 56-6600    |
| 60 kg   | 550 mm | 766H5500B | 56-9368    |

**VODIACE LIŠTY TIP ON**

| Nosnosť | Dĺžka  | Typ       | Obj. číslo |
|---------|--------|-----------|------------|
| 40 kg   | 300 mm | 760H3000T | 56-1112    |
| 40 kg   | 350 mm | 760H3500T | 56-1113    |
| 40 kg   | 400 mm | 760H4000T | 56-1114    |
| 40 kg   | 450 mm | 760H4500T | 56-1115    |
| 40 kg   | 500 mm | 760H5000T | 56-1116    |
| 60 kg   | 450 mm | 766H4500T | 56-1117    |
| 60 kg   | 500 mm | 766H5000T | 56-1118    |
| 60 kg   | 550 mm | 766H5500T | 56-1119    |

**SYNCHRONIZÁCIA**

| Typ       | Názov    | Obj. číslo |
|-----------|----------|------------|
| T57.7400  | Pastorok | 56-1121    |
| ZST.1137W | Hriadeľ  | 56-1122    |

**SPOJKY**

|       | Typ      | Obj. číslo |
|-------|----------|------------|
| Ľavá  | T51.7601 | 56-6449    |
| Pravá | T51.7601 | 56-6616    |

## 2.6 TANDEM



### TANDEM ČIASTOČNÝ VÝSUV BEZ BRZDY 1

| Nosnosť | Menovitá dĺžka | Typ      | Obj. číslo |
|---------|----------------|----------|------------|
| 30 kg   | 270 mm         | 550H2700 | 56-0021    |
| 30 kg   | 300 mm         | 550H3000 | 56-0387    |
| 30 kg   | 350 mm         | 550H3500 | 56-0091    |
| 30 kg   | 400 mm         | 550H4000 | 56-0198    |
| 30 kg   | 450 mm         | 550H4500 | 56-0092    |
| 30 kg   | 500 mm         | 550H5000 | 56-0297    |
| 30 kg   | 550 mm         | 550H5500 | 56-0093    |
| 30 kg   | 600 mm         | 550H6000 | 56-0219    |
| 30 kg   | 650 mm         | 550H6500 | 56-0218    |

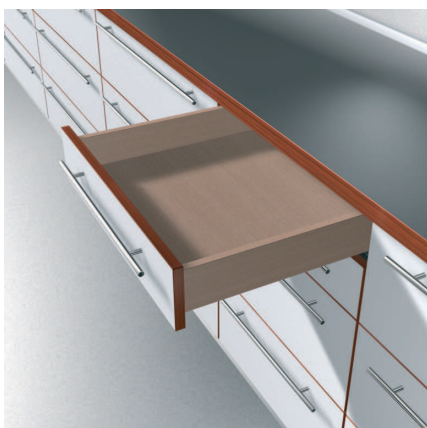

ZÁSUVKA TANDEM ČIASTOČNÝ VÝSUV



### TANDEM ČIASTOČNÝ VÝSUV S BRZDOU 1

| Nosnosť | Menovitá dĺžka | Typ       | Obj. číslo |
|---------|----------------|-----------|------------|
| 30 kg   | 270 mm         | 550H2700B | 56-1021    |
| 30 kg   | 300 mm         | 550H3000B | 56-1387    |
| 30 kg   | 350 mm         | 550H3500B | 56-1091    |
| 30 kg   | 400 mm         | 550H4000B | 56-2198    |
| 30 kg   | 450 mm         | 550H4500B | 56-1092    |
| 30 kg   | 500 mm         | 550H5000B | 56-1297    |
| 30 kg   | 550 mm         | 550H5500B | 56-1093    |

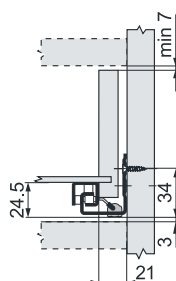

Potrebný priestor v korpusu pre TANDEM 550H

Menovitá dĺžka (mm)

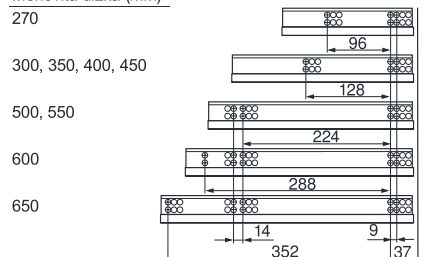

Poloha upevnenia korpusových lišt skrutkami pre TANDEM 550H



### TANDEM PLNOVÝSUV BEZ BRZDY 1

| Nosnosť | Menovitá dĺžka | Typ      | Obj. číslo |
|---------|----------------|----------|------------|
| 30 kg   | 250 mm         | 560H2500 | 56-0619    |
| 30 kg   | 270 mm         | 560H2700 | 56-0089    |
| 30 kg   | 300 mm         | 560H3000 | 56-0276    |
| 30 kg   | 350 mm         | 560H3500 | 56-0211    |
| 30 kg   | 400 mm         | 560H4000 | 56-0212    |
| 30 kg   | 450 mm         | 560H4500 | 56-0160    |
| 30 kg   | 500 mm         | 560H5000 | 56-0209    |
| 30 kg   | 550 mm         | 560H5500 | 56-0424    |
| 30 kg   | 600 mm         | 560H6000 | 56-5464    |

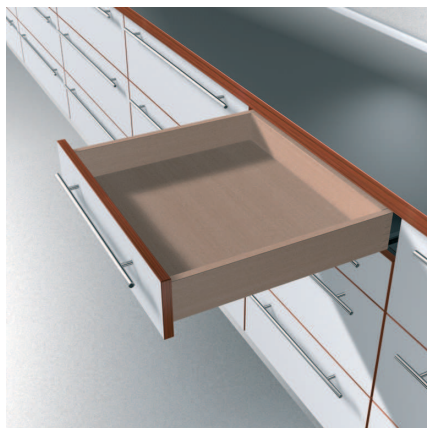

ZÁSUVKA TANDEM PLNOVÝSUV



### TANDEM PLNOVÝSUV S BRZDOU 1

| Nosnosť | Menovitá dĺžka | Typ       | Obj. číslo |
|---------|----------------|-----------|------------|
| 30 kg   | 250 mm         | 560H2500B | 56-1619    |
| 30 kg   | 270 mm         | 560H2700B | 56-1089    |
| 30 kg   | 300 mm         | 560H3000B | 56-1276    |
| 30 kg   | 350 mm         | 560H3500B | 56-1211    |
| 30 kg   | 380 mm         | 560H3800B | 56-0706    |
| 30 kg   | 400 mm         | 560H4000B | 56-1212    |
| 30 kg   | 450 mm         | 560H4500B | 56-1160    |
| 30 kg   | 500 mm         | 560H5000B | 56-1209    |
| 30 kg   | 550 mm         | 560H5500B | 56-1424    |
| 30 kg   | 600 mm         | 560H6000B | 56-5463    |

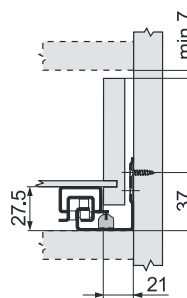

Potrebný priestor v korpusu pre TANDEM 560H a 566H

Menovitá dĺžka (mm)

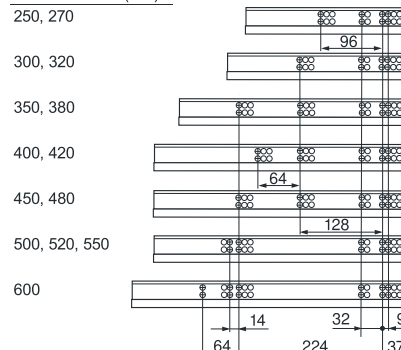

Poloha upevnenia korpusových lišt skrutkami pre TANDEM 560H

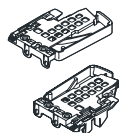

SPOJKA T51.1700

Menovitá dĺžka (mm)

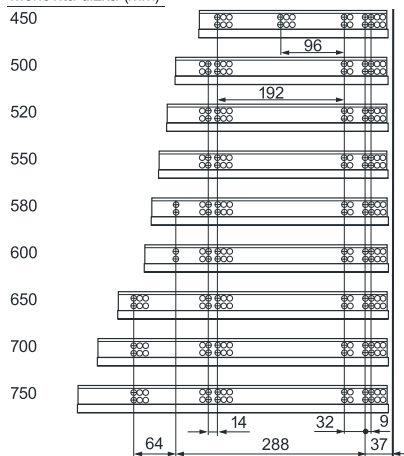
 Poloha upevnenia korpusových lišt skrutkami  
pre TANDEM 566H

ZÁSUVKA TANDEM S POZDĹŽNYM RELINGOM

POZDĹŽNY RELING  
S DRŽIAKOM CHRBTÁ
**TANDEM PLNOVÝSUV S BRZDOU** <sup>1</sup>

| Nosnosť | Menovitá dĺžka | Typ       | Obj. číslo |
|---------|----------------|-----------|------------|
| 50 kg   | 450 mm         | 566H4500B | 56-1103    |
| 50 kg   | 500 mm         | 566H5000B | 56-2209    |
| 50 kg   | 550 mm         | 566H5500B | 56-0703    |
| 50 kg   | 600 mm         | 566H6000B | 56-1213    |
| 50 kg   | 650 mm         | 566H6500B | 56-1218    |
| 50 kg   | 700 mm         | 566H7000B | 56-0691    |
| 50 kg   | 750 mm         | 566H7500B | 56-0543    |

**SPOJKA**

| Typ        | Obj. číslo |
|------------|------------|
| T51.1700,L | 56-0094    |
| T51.1700,R | 56-1094    |

**ÚCHYTKA RELINGU**

| Typ      | Obj. číslo |
|----------|------------|
| ZRR.9000 | 56-1572    |

**RELING POZDĹŽNY S DRŽIAKOM CHRBTÁ**

| Menovitá dĺžka | Povrchová úprava | Typ         | Obj. číslo |
|----------------|------------------|-------------|------------|
| 400 mm         | Chróm            | ZRE.363A.ID | 56-0197    |
| 450 mm         | Chróm            | ZRE.413A.ID | 56-0363    |
| 500 mm         | Chróm            | ZRE.463A.ID | 56-0364    |
| 550 mm         | Chróm            | ZRE.513A.ID | 56-0693    |
| 600 mm         | Chróm            | ZRE.563A.ID | 56-2563    |
| 650 mm         | Chróm            | ZRE.613A.ID | 56-0696    |

**2.7 PRÍSLUŠENSTVO PRE TANDEM**

TIP-ON PRE TANDEM

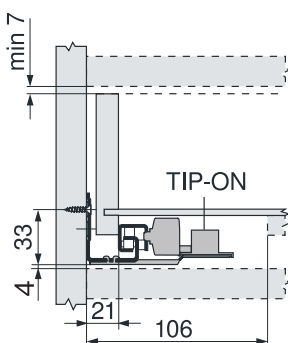
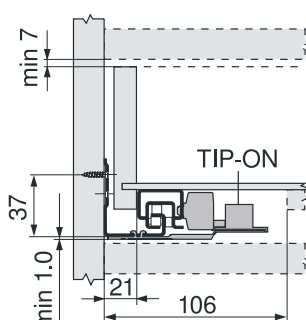
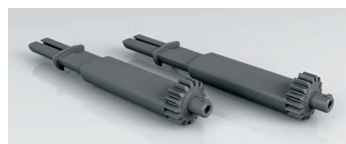
 Potrebný priestor v korpuse  
pre TIP-ON T55.1150

 Potrebný priestor v korpuse  
pre TIP-ON T55.7150

T55.00R



T55.889W

**TIP-ON**

| Typ      | Použitie             | Obj. číslo |
|----------|----------------------|------------|
| T55.1150 | Čiastočný výsuv 550H | 56-0702    |
| T55.7150 | Plný výsuv 560H      | 56-0699    |

**SYNCHRONIZÁCIA\***

| Typ      | Názov                           | Obj. číslo |
|----------|---------------------------------|------------|
| T55.00R  | Pastorok                        | 56-5509    |
| T55.889W | Hriadeľ (šírka korpusu 1200 mm) | 56-5588    |

\* Odporúčame použiť od šírky čela zásuvky 550 mm

**SERVODRIVE\***

\* Komponenty vhodné ako pre TANDEMBOX (str. 23)



## 2.8 METABOX, T-LINEBOX



### VODIACE LIŠTY S BOČNICAMI METABOX 1

| Výška bočnic | Dĺžka bočnic | Povrchová úprava | Typ       | Obj. číslo |
|--------------|--------------|------------------|-----------|------------|
| 54 mm        | 270 mm       | Biela            | 320N2700C | 56-0393    |
| 54 mm        | 350 mm       | Biela            | 320N3500C | 56-0355    |
| 54 mm        | 400 mm       | Biela            | 320N4000C | 56-0273    |
| 54 mm        | 450 mm       | Biela            | 320N4500C | 56-0164    |
| 54 mm        | 450 mm       | Šedá             | 320N4500C | 56-1164    |
| 54 mm        | 500 mm       | Biela            | 320N5000C | 56-0152    |
| 54 mm        | 500 mm       | Šedá             | 320N5000C | 56-0448    |
| 54 mm        | 550 mm       | Biela            | 320N5500C | 56-0389    |



ZÁSUVKA METABOX TYPU N

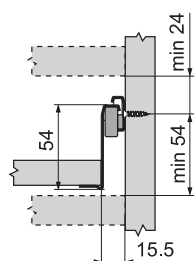

Potrebný priestor v korpuse  
pre výšku bočnic 54 mm

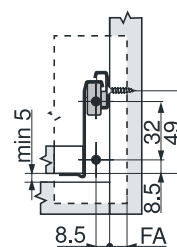

Rozmery na montáž čela  
pre bočnice s výškou 54 mm  
(FA - presah čela)



### VODIACE LIŠTY S BOČNICAMI METABOX 1

| Výška bočnic | Dĺžka bočnic | Povrchová úprava | Typ       | Obj. číslo |
|--------------|--------------|------------------|-----------|------------|
| 86 mm        | 270 mm       | Biela            | 320M2700C | 56-0196    |
| 86 mm        | 270 mm       | Šedá             | 320M2700C | 56-1196    |
| 86 mm        | 350 mm       | Biela            | 320M3500C | 56-0107    |
| 86 mm        | 350 mm       | Šedá             | 320M3500C | 56-0202    |
| 86 mm        | 400 mm       | Biela            | 320M4000C | 56-0106    |
| 86 mm        | 400 mm       | Šedá             | 320M4000C | 56-0203    |
| 86 mm        | 450 mm       | Biela            | 320M4500C | 56-0067    |
| 86 mm        | 450 mm       | Šedá             | 320M4500C | 56-0204    |
| 86 mm        | 500 mm       | Biela            | 320M5000C | 56-0072    |
| 86 mm        | 500 mm       | Šedá             | 320M5000C | 56-0439    |
| 86 mm        | 550 mm       | Biela            | 320M5500C | 56-0108    |
| 86 mm        | 550 mm       | Šedá             | 320M5500C | 56-0205    |

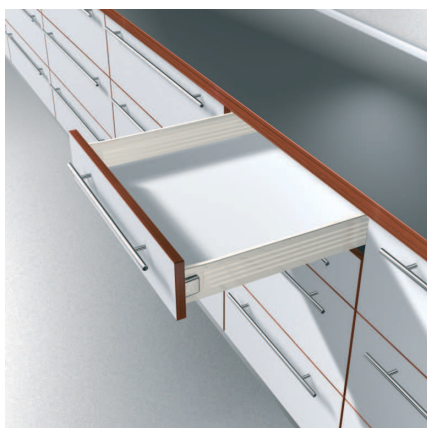

ZÁSUVKA METABOX TYPU M

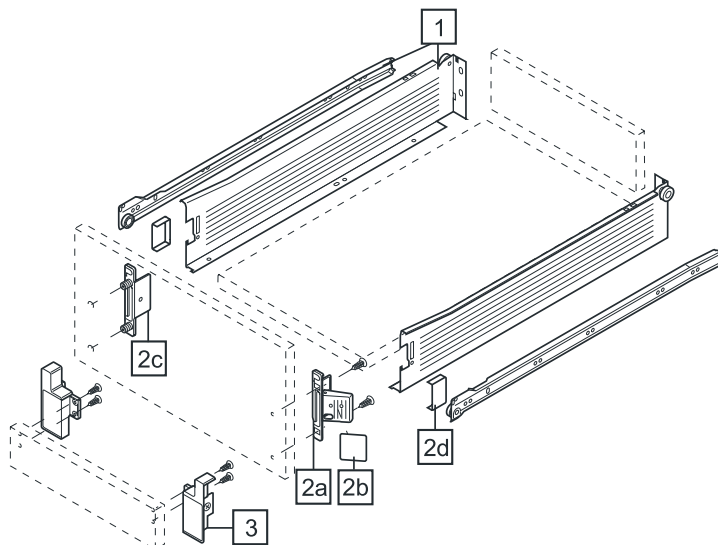

ZLOŽENIE ZÁSUVKY METABOX

# VÝSUVY ZÁSUVKOVÉ

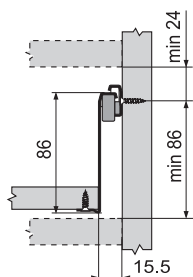

Potrebný priestor v korpuse  
pre výšku bočnic 86 mm

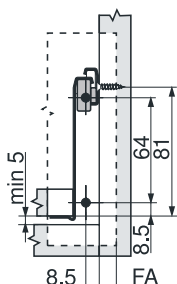

Rozmery na montáž čela  
pre bočnice s výškou 86 mm  
(FA - presah čela)

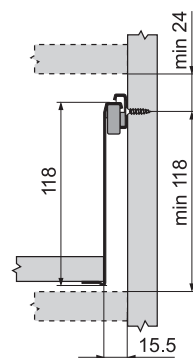

Potrebný priestor v korpuse  
pre výšku bočnic 118 mm

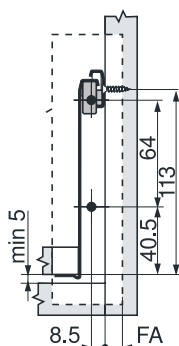

Rozmery na montáž čela  
pre bočnice s výškou 118 mm  
(FA - presah čela)



ZÁSUVKA METABOX TYPU H

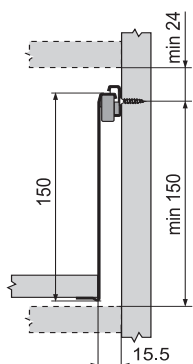

Potrebný priestor v korpuse  
pre výšku bočnic 150 mm

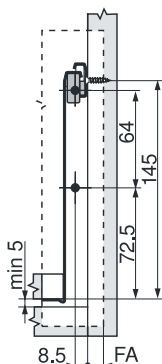

Rozmery na montáž čela  
pre bočnice s výškou 150 mm  
(FA - presah čela)

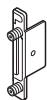

UPEVNENIE ČELA  
ZSF.1700

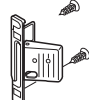

UPEVNENIE ČELA  
ZSF.1200



UPEVNENIE ČELA  
ZSF.1510

## VODIACE LIŠTY S BOČNICAMI T-LINEBOX 1

PRIAZNIVÁ  
CENA 1

| Výška bočnic | Dĺžka bočnic | Povrchová úprava | Obj. číslo  |
|--------------|--------------|------------------|-------------|
| 86 mm        | 270 mm       | Biela            | 24-03101271 |
| 86 mm        | 300 mm       | Biela            | 24-03101301 |
| 86 mm        | 350 mm       | Biela            | 24-03101351 |
| 86 mm        | 400 mm       | Biela            | 24-03101401 |
| 86 mm        | 450 mm       | Biela            | 24-03101451 |
| 86 mm        | 500 mm       | Biela            | 24-03101501 |
| 86 mm        | 550 mm       | Biela            | 24-03101551 |

TOP  
KVALITA

## VODIACE LIŠTY S BOČNICAMI METABOX 1

| Výška bočnic | Dĺžka bočnic | Povrchová úprava | Typ       | Obj. číslo |
|--------------|--------------|------------------|-----------|------------|
| 118 mm       | 350 mm       | Biela            | 320K3500C | 56-0398    |
| 118 mm       | 400 mm       | Biela            | 320K4000C | 56-0504    |
| 118 mm       | 450 mm       | Biela            | 320K4500C | 56-0312    |
| 118 mm       | 500 mm       | Biela            | 320K5000C | 56-0313    |
| 118 mm       | 550 mm       | Biela            | 320K5500C | 56-0390    |

TOP  
KVALITA

## VODIACE LIŠTY S BOČNICAMI METABOX 1

| Výška bočnic | Dĺžka bočnic | Povrchová úprava | Typ       | Obj. číslo |
|--------------|--------------|------------------|-----------|------------|
| 150 mm       | 450 mm       | Biela            | 320H4500C | 56-0033    |
| 150 mm       | 450 mm       | Šedá             | 320H4500C | 56-1033    |
| 150 mm       | 500 mm       | Biela            | 320H5000C | 56-0130    |
| 150 mm       | 500 mm       | Šedá             | 320H5000C | 56-1130    |

PRIAZNIVÁ  
CENA 1

## VODIACE LIŠTY S BOČNICAMI T-LINEBOX 1

| Výška bočnic | Dĺžka bočnic | Povrchová úprava | Obj. číslo  |
|--------------|--------------|------------------|-------------|
| 150 mm       | 450 mm       | Biela            | 24-03104450 |
| 150 mm       | 500 mm       | Biela            | 24-03104500 |

TOP  
KVALITA

## UPEVNENIE ČELA 2a + 2c

| Verzia                    | Typ      | Obj. číslo |
|---------------------------|----------|------------|
| Na skrutky - ľavé         | ZSF.1700 | 56-0064    |
| Na skrutky - pravé        | ZSF.1700 | 56-1064    |
| Na hmoždinky CLIP - ľavé  | ZSF.1200 | 56-0344    |
| Na hmoždinky CLIP - pravé | ZSF.1200 | 56-1344    |
| Na hmoždinky - ľavé       | ZSF.1510 | 56-0079    |
| Na hmoždinky - pravé      | ZSF.1510 | 56-1079    |

TOP  
KVALITA

## KRYTKA 2d

| Typ      | Povrchová úprava | Obj. číslo |
|----------|------------------|------------|
| ZAA.3500 | Biela            | 56-0065    |
| ZAA.3500 | Šedá             | 56-0350    |

**RELING POZDĽŽNY**



| Dĺžka bočnic | Povrchová úprava | Typ         | Balenie | Obj. číslo |
|--------------|------------------|-------------|---------|------------|
| 350 mm       | Biela            | ZRG.321V.ID | ks      | 56-0367    |
| 350 mm       | Šedá             | ZRE.321S.ID | ks      | 56-1367*   |
| 400 mm       | Biela            | ZRE.371S.ID | ks      | 56-0255    |
| 400 mm       | Šedá             | ZRE.371S.ID | ks      | 56-0047*   |
| 450 mm       | Biela            | ZRE.421S.ID | ks      | 56-0256    |
| 450 mm       | Šedá             | ZRE.421S.ID | ks      | 56-0571*   |
| 500 mm       | Biela            | ZRE.471S.ID | ks      | 56-0257    |
| 500 mm       | Šedá             | ZRE.471S.ID | ks      | 56-1257*   |
| 550 mm       | Biela            | ZRE.521S.ID | ks      | 56-0322    |
| 550 mm       | Šedá             | ZRE.521S.ID | ks      | 56-0629*   |

\*Potrebné objednať aj príslušný počet upevnení ZRB.8000.NI, obj. číslo 56-0572.

**RELING POZDĽŽNY T-LINE**



| Dĺžka bočnic | Povrchová úprava | Balenie | Obj. číslo  |
|--------------|------------------|---------|-------------|
| 300 mm       | Biela            | súprava | 24-03901300 |
| 400 mm       | Biela            | súprava | 24-03901400 |
| 450 mm       | Biela            | súprava | 24-03901450 |
| 500 mm       | Biela            | súprava | 24-03901500 |
| 550 mm       | Biela            | súprava | 24-03901550 |

**VÝSUV SPODNÝ**

| Dĺžka  | farba | Obj. číslo  |
|--------|-------|-------------|
| 250 mm | Biela | 24-02101250 |
| 300 mm | Biela | 24-02101300 |
| 350 mm | Biela | 24-02101350 |
| 400 mm | Biela | 24-02101400 |
| 450 mm | Biela | 24-02101450 |
| 500 mm | Biela | 24-02101500 |
| 550 mm | Biela | 24-02101550 |
| 600 mm | Biela | 24-02101600 |

**PLNOVÝSUV GULIČKOVÝ S BRZDOU**

| Dĺžka  | Obj. číslo  |
|--------|-------------|
| 350 mm | 24-04289350 |
| 400 mm | 24-04289400 |
| 450 mm | 24-04289450 |
| 500 mm | 24-04289500 |
| 550 mm | 20-02307004 |
| 600 mm | 20-02308004 |

**PLNOVÝSUV GULIČKOVÝ BEZ BRZDY**

| Dĺžka  | obj. číslo  |
|--------|-------------|
| 250 mm | 62-8250     |
| 300 mm | 62-8300     |
| 350 mm | 62-8350     |
| 400 mm | 62-8400     |
| 450 mm | 24-04227450 |
| 500 mm | 24-04227500 |
| 550 mm | 62-8550     |
| 600 mm | 62-8600     |
| 650 mm | 62-8650     |
| 700 mm | 62-8700     |



ZÁSUVKA METABOX S POZDĽŽNYM RELINGOM

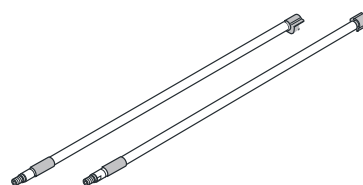

POZDĽŽNY RELING



VÝSUVY ZÁSUVKOVÉ

**3.1 VÝKLOPY AVENTOS**

AVENTOS HF

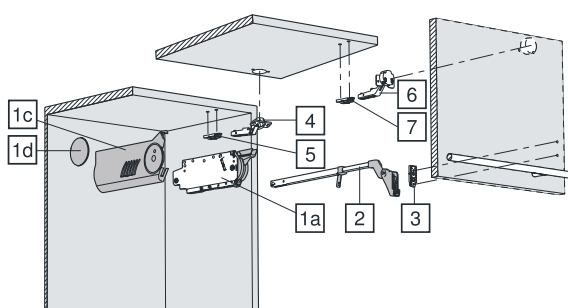

ZLOŽENIE VÝKLOPU AVENTOS HF

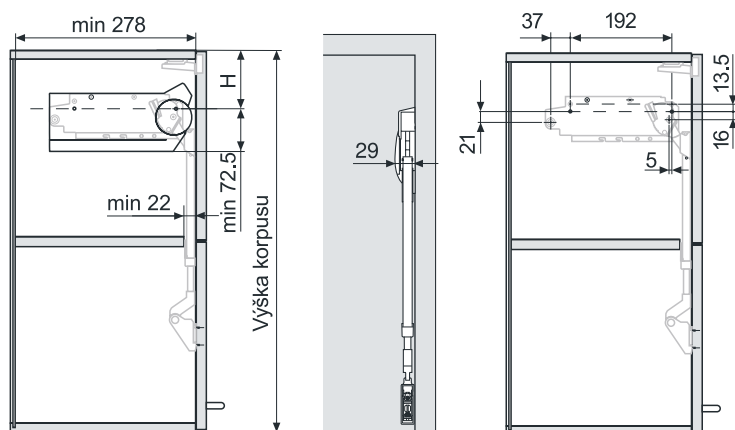

Potreba miesta pre AVENTOS HF

Poloha upevňovacích skrutiek

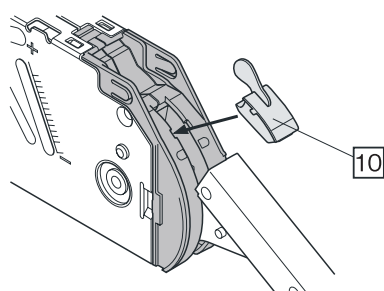

OBMEDZOVAČ UHLA OTVORENIA

**SÚPRAVA ZDVÍHAČOV S KRYTKAMI** 1a + 1c + 1d

| Typ     | Ukazovateľ výkonnosti LF | Obj. číslo |
|---------|--------------------------|------------|
| 20F2200 | 2600 - 5500              | 56-2200    |
| 20F2500 | 5350 - 10150             | 56-2500    |
| 20F2800 | 9000 - 17250             | 56-2800    |

**SÚPRAVA TELESKOPOV** 2

| Typ     | Výška korpusu (mm) | Obj. číslo |
|---------|--------------------|------------|
| 20F3200 | 480 - 570          | 56-3209    |
| 20F3500 | 560 - 710          | 56-3509    |
| 20F3800 | 700 - 900          | 56-3809    |
| 20F3900 | 760 - 1040         | 56-3909    |

**MONTÁŽNA PODLOŽKA K TELESKOPOM** 3

| Typ      | Použitie                         | Obj. číslo        |
|----------|----------------------------------|-------------------|
| 175H5400 | Drevené čielka a široké ALU rámy | 56-0229           |
| 175H5B00 | Úzke ALU rámy                    | 56-5553 + 56-6553 |

**ZÁVES CLIP TOP 120°** 4

| Typ        | Použitie                         | Obj. číslo |
|------------|----------------------------------|------------|
| 70T5550.TL | Drevené čielka a široké ALU rámy | 56-5550    |
| 72T550A.TL | Úzke ALU rámy                    | 56-5551    |

**MONTÁŽNA PODLOŽKA K ZÁVESU CLIP TOP 120°** 5

| Typ      | Obj. číslo |
|----------|------------|
| 175H5400 | 56-0229    |

**STREDOVÝ ZÁVES CLIP TOP** 6

| Typ      | Použitie                         | Obj. číslo |
|----------|----------------------------------|------------|
| 78Z5500T | Drevené čielka a široké ALU rámy | 56-5500    |
| 78Z550AT | Úzke ALU rámy                    | 56-5552    |

**MONTÁŽNA PODLOŽKA**
**K STREDOVÉMU ZÁVESU CLIP TOP** 7

| Typ      | Použitie                         | Obj. číslo |
|----------|----------------------------------|------------|
| 175H5400 | Drevené čielka a široké ALU rámy | 56-0229    |
| 175H5A00 | Úzke ALU rámy                    | 56-0694    |

**OBMEDZOVAČ UHLA OTVORENIA** 10

| Typ     | Uhol obmedzenia | Obj. číslo |
|---------|-----------------|------------|
| 20F7051 | 104°            | 56-0729    |
| 20F7011 | 83°             | 56-0728    |

SÚPRAVA ZDVÍHAČOV **1**



| Typ     | Výška korpusu (mm) | Obj. číslo |
|---------|--------------------|------------|
| 20S2A00 | 350 - 525          | 56-3302    |
| 20S2B00 | 350 - 525          | 56-3301    |
| 20S2C00 | 350 - 525          | 56-2401    |
| 20S2D00 | 526 - 675          | 56-9016    |
| 20S2E00 | 526 - 675          | 56-3312    |
| 20S2F00 | 526 - 675          | 56-3303    |
| 20S2G00 | 676 - 800          | 56-3304    |
| 20S2H00 | 676 - 800          | 56-3305    |

RAMENÁ **2**



| Typ         | Obj. číslo |
|-------------|------------|
| 20S35000.05 | 56-3505    |

KRYTKY **3a** + **3b**



| Typ     | Farba | Obj. číslo |
|---------|-------|------------|
| 20S8000 | Sivá  | 56-2011    |

SÚPRAVA UPEVNENIA ČELA **4**



| Typ      | Použitie                           | Obj. číslo |
|----------|------------------------------------|------------|
| 20S4200  | Drevené čielka a široké ALU rámiky | 56-4200    |
| 20S4200A | Úzke ALU rámiky                    | 56-5204    |

TYČ PRIEČNEHO STABILIZÁTORA OKRÚHLA **5**



| Typ      | Dĺžka (na skrátenie) | Obj. číslo |
|----------|----------------------|------------|
| 20Q1061U | 1061 mm              | 56-3205    |

SÚPRAVA SPOJOVACÍCH DIELOV  
PRIEČNEJ STABILIZÁCIE **6**



| Typ     | Obj. číslo |
|---------|------------|
| 20Q091Z | 56-3206    |

SÚPRAVA ZDVÍHAČOV S KRYTKAMI **1a** + **1c** + **1d**



| Typ     | Obj. číslo |
|---------|------------|
| 20L2100 | 56-2021    |
| 20L2300 | 56-2310    |
| 20L2500 | 56-2510    |
| 20L2700 | 56-2027    |
| 20L2900 | 56-5029    |



AVENTOS HS

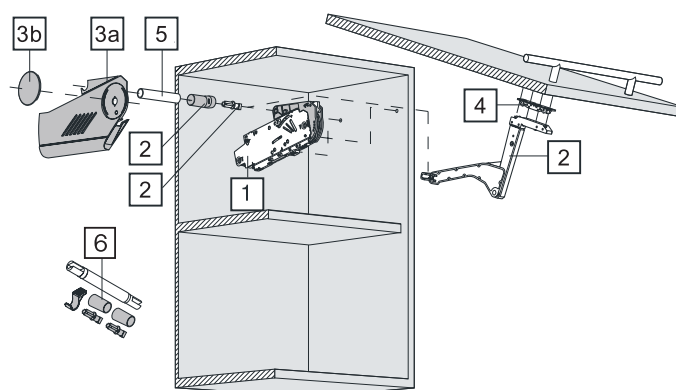

ZLOŽENIE VÝKLOPU AVENTOS HS

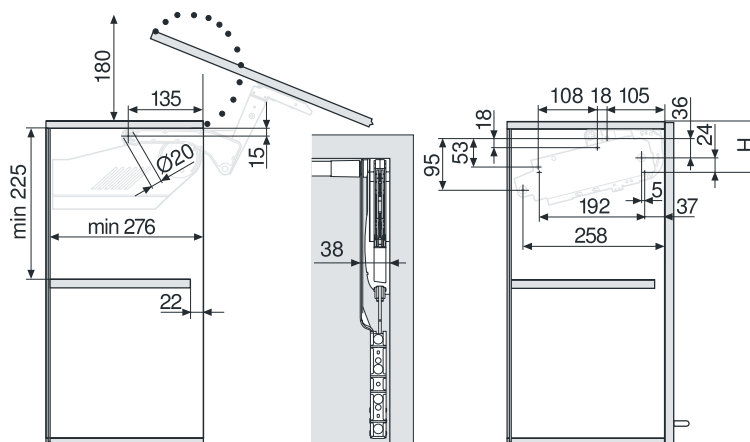

Potreba miesta pre AVENTOS HS

Poloha upevňovacích skrutiek

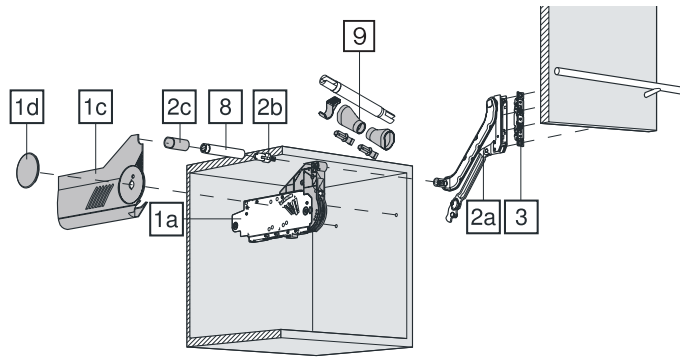
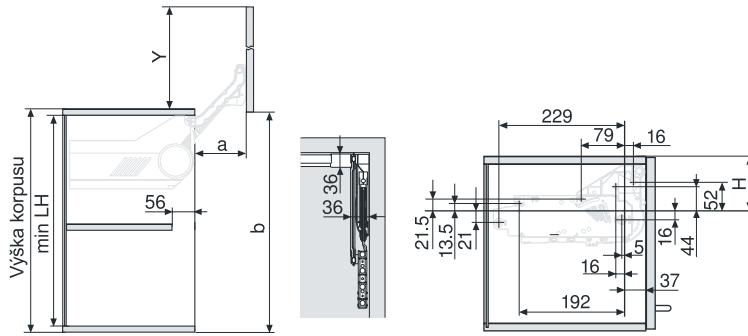

**ZLOŽENIE VÝKLOPU AVENTOS HL**

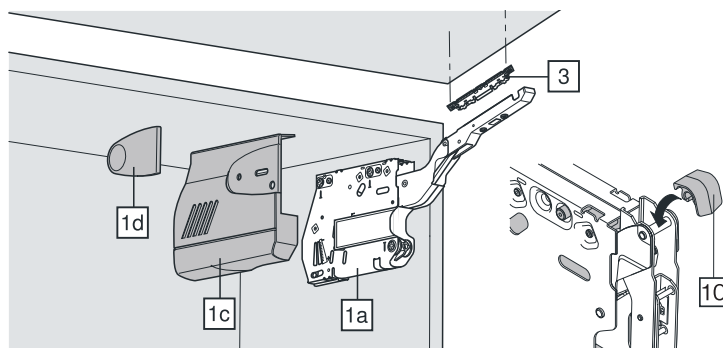
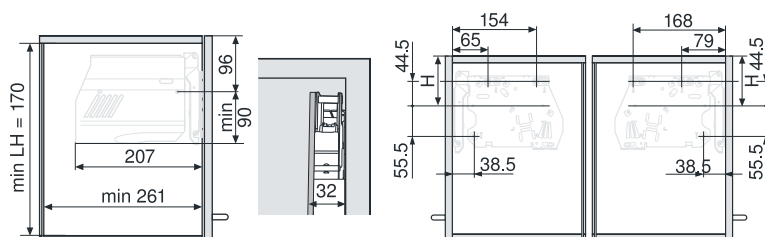
**Potreba miesta pre AVENTOS HL**
**Poloha upevňovacích skrutiek**

**AVENTOS HK**

**ZLOŽENIE VÝKLOPU AVENTOS HK**

**SÚPRAVA RAMIEN** **2a** + **2b** + **2c**

| Typ     | Výška korpusu (mm) | Obj. číslo |
|---------|--------------------|------------|
| 20L3200 | 300 – 349          | 56-3200    |
| 20L3500 | 350 – 399          | 56-3510    |
| 20L3800 | 400 – 550          | 56-2038    |
| 20L3900 | 450 – 580          | 56-2039    |

**SÚPRAVA UPEVNENIA ČELA** **3**

| Typ      | Použitie                           | Obj. číslo |
|----------|------------------------------------|------------|
| 20S4200  | Drevené čielka a široké ALU rámiky | 56-4200    |
| 20S4200A | Úzke ALU rámiky                    | 56-5204    |

**TYČ PRIEČNEHO STABILIZÁTORA OVÁLNÁ** **5**

| Typ       | Dĺžka (na skrátenie) | Obj. číslo |
|-----------|----------------------|------------|
| 20Q1061UA | 1061 mm              | 56-2010    |

**SÚPRAVA SPOJOVACÍCH DIELOV**
**PRIEČNEJ STABILIZÁCIE** **9**

| Typ      | Obj. číslo |
|----------|------------|
| 20Q091ZA | 56-3027    |

**SÚPRAVA ZDVÍHAČOV S KRYTKAMI** **1a** + **1c** + **1d**

| Typ     | Ukazovateľ výkonnosti LF | Obj. číslo |
|---------|--------------------------|------------|
| 20K2300 | 480 – 1500               | 56-2300    |
| 20K2500 | 750 – 2500               | 56-2511    |
| 20K2700 | 1500 – 4900              | 56-2700    |
| 20K2900 | 3200 – 9000              | 56-2900    |

**SÚPRAVA UPEVNENIA ČELA** **3**

| Typ      | Použitie                           | Obj. číslo |
|----------|------------------------------------|------------|
| 20S4200  | Drevené čielka a široké ALU rámiky | 56-4200    |
| 20S4200A | Úzke ALU rámiky                    | 56-5204    |

**OBMEDZOVAČ UHLA OTVORENIA** **10**

| Typ     | Uhol obmedzenia | Obj. číslo |
|---------|-----------------|------------|
| 20K7041 | 100°            | 56-7041    |
| 20K7011 | 75°             | 56-7011    |

**SÚPRAVA ZDVÍHAČOV S KRYTKAMI** 1a + 1b



| Typ     | Ukazovateľ výkonnosti LF | Obj. číslo |
|---------|--------------------------|------------|
| 20K2B00 | 220 - 500                | 56-2111    |
| 20K2C00 | 400 - 1000               | 56-2112    |
| 20K2E00 | 960 - 2215               | 56-2113    |

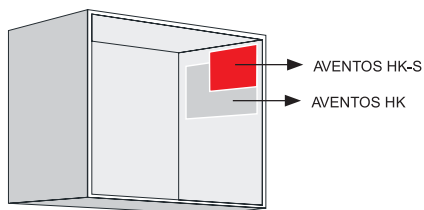

AVENTOS HK-S



**SÚPRAVA ZDVÍHAČOV (PRIEMYSELNÉ BALENIE - 40 KS)**

| Typ     | Ukazovateľ výkonnosti LF | Obj. číslo |
|---------|--------------------------|------------|
| 20K2C01 | 400-1000                 | 56-2102    |
| 20K2E01 | 960-2215                 | 56-2103    |

\*krytky nie su súčasťou balenia



**SÚPRAVA UPEVNENIA ČELA** 2

| Typ      | Použitie                         | Obj. číslo        |
|----------|----------------------------------|-------------------|
| 20K4A00  | Drevené čielka a široké ALU rámy | 56-4401           |
| 20K4A00A | Úzke ALU rámy                    | 56-4402 + 56-4403 |

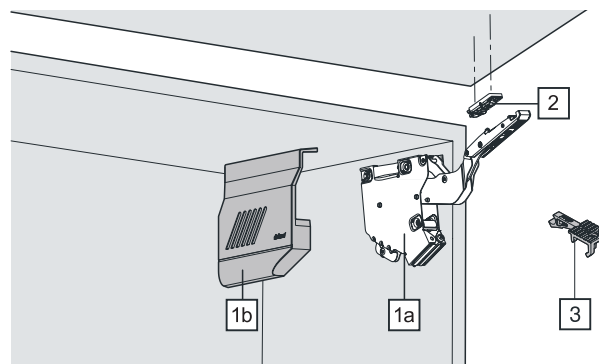

ZLOŽENIE VÝKLOPU AVENTOS HK-S

**OBMEDZOVAČ UHLA OTVORENIA** 3



| Typ     | Uhol obmedzenia | Obj. číslo |
|---------|-----------------|------------|
| 20K7A41 | 100°            | 56-7441    |
| 20K7A11 | 75°             | 56-7411    |

TIP PRE VÁS !!! NÁRADIE, KTORÉ BY VÁM NEMALO CHÝBAŤ.

**BIT PZ2 KRÍŽOVÝ**

| Typ        | Dĺžka a veľkosť | Obj. číslo |
|------------|-----------------|------------|
| BIT-PZ KS2 | 39 mm, 2        | 56-0719    |

**SKRUTKOVACĎ PZ2 BLUM**

| Typ       | Obj. číslo |
|-----------|------------|
| 303.756.1 | 56-1003    |

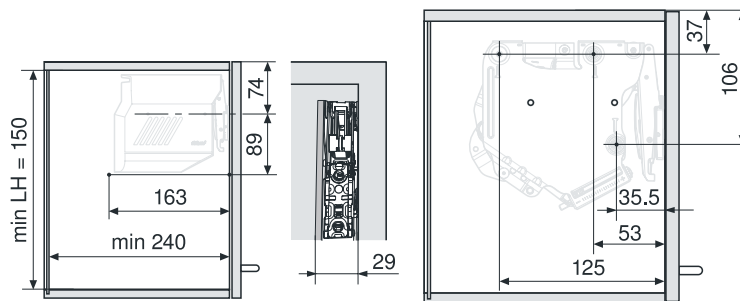

Potreba miesta pre AVENTOS HK-S

Poloha upevňovacích skrutiek

**3.2 VÝKLOPY OSTATNÉ**

**VÝKLOP PLYNOVÝ**



| Výtlačná sila | Obj. číslo | Výtlačná sila | Obj. číslo |
|---------------|------------|---------------|------------|
| 30 N          | 13-6248    | 60 N          | 13-6480    |
| 40 N          | 13-6247    | 80 N          | 13-6408    |
| 50 N          | 13-6405    | 100 N         | 13-6450    |



**VÝKLOP PRUŽINOVÝ**



| Typ   | Výtlačná sila | Povrchová úprava | Obj. číslo  |
|-------|---------------|------------------|-------------|
| Ľavý  | 180 N         | Nikel            | 71-37244612 |
| Pravý | 180 N         | Nikel            | 71-37244602 |



**VÝKLOP KLÍBOVÝ\***



| Odstup | Povrchová úprava | Obj. číslo  |
|--------|------------------|-------------|
| 28 mm  | Nikel            | 71-37366611 |
| 37 mm  | Nikel            | 71-37366612 |

\*Pre drevené dverka alebo hliníkový rámik do šírky 45 mm.

### 3.3 ÚCHYTKY



#### ÚCHYTKA

| Rozmer            | Povrchová úprava | Obj. číslo  |
|-------------------|------------------|-------------|
| 182 x 12 / 160 mm | Nerez brúsený    | 17-01210160 |
|                   |                  | 17-01210172 |
| 214 x 12 / 192 mm | Nerez brúsený    | 17-01210192 |
| 278 x 12 / 256 mm | Nerez brúsený    | 17-01210256 |
| 394 x 12 / 372 mm | Nerez brúsený    | 17-01210372 |
| 470 x 12 / 448 mm | Nerez brúsený    | 17-01210448 |

#### ÚCHYTKA

| Rozmer          | Povrchová úprava | Obj. číslo  |
|-----------------|------------------|-------------|
| 184x16 / 160 mm | Nikel            | 17-08247532 |

#### ÚCHYTKA

| Rozmer            | Povrchová úprava | Obj. číslo  |
|-------------------|------------------|-------------|
| 292 x 16 / 280 mm | Hliník matný     | 17-08455947 |
| 332 x 16 / 320 mm | Hliník matný     | 17-08456147 |
| 492 x 16 / 480 mm | Hliník matný     | 17-08456547 |
| 652 x 16 / 640 mm | Hliník matný     | 17-08456747 |

#### ÚCHYTKA

| Rozmer            | Povrchová úprava | Obj. číslo  |
|-------------------|------------------|-------------|
| 157 x 12 / 128 mm | Nerez            | 17-08577419 |

#### ÚCHYTKA

| Rozmer            | Povrchová úprava | Obj. číslo  |
|-------------------|------------------|-------------|
| 163 x 24 / 128 mm | Chróm matný      | 17-08634429 |
| 195 x 24 / 160 mm | Hliník nerez     | 17-08634546 |
| 228 x 24 / 192 mm | Hliník nerez     | 17-08634646 |

#### ÚCHYTKA

| Rozmer            | Povrchová úprava | Obj. číslo  |
|-------------------|------------------|-------------|
| 180 x 20 / 160 mm | Hliník nerez     | 17-08652541 |
| 180 x 20 / 160 mm | Hliník nikel     | 17-08652542 |
| 180 x 20 / 160 mm | Chróm matný      | 17-08652546 |
| 180 x 20 / 160 mm | Nerez lesklý     | 17-08652519 |
| Ø 20 mm           | Nikel matný      | 17-08668258 |



**ÚCHYTKA**

| Rozmer            | Povrchová úprava | Obj. číslo  |
|-------------------|------------------|-------------|
| 206 x 27 / 192 mm | Lesklý nerez     | 17-08700619 |
| 170 x 20 / 160 mm | Hliník chróm     | 17-08701547 |
| 248 x 20 / 238 mm | Chróm lesklý     | 17-08701848 |
| 330 x 20 / 320 mm | Chróm lesklý     | 17-08701947 |
| 398 x 20 / 388 mm | Chróm lesklý     | 17-08702148 |



**ÚCHYTKA**

| Rozmer            | Povrchová úprava | Obj. číslo  |
|-------------------|------------------|-------------|
| 162 x 18 / 128 mm | Chróm matný      | 17-08770031 |



**ÚCHYTKA**

| Rozmer            | Povrchová úprava   | Obj. číslo  |
|-------------------|--------------------|-------------|
| 160 x 22 / 128 mm | Hliník nerez       | 17-08845046 |
| 160 x 22 / 128 mm | Hliník matný chróm | 17-08845047 |
| 192 x 22 / 160 mm | Hliník matný chróm | 17-08845143 |
| 192 x 22 / 160 mm | Hliník nerez       | 17-08845146 |



**ÚCHYTKA**

| Rozmer            | Povrchová úprava | Obj. číslo  |
|-------------------|------------------|-------------|
| 172 x 16 / 160 mm | Nerez brúsený    | 17-08872546 |
| 204 x 16 / 192 mm | Nerez brúsený    | 17-08872646 |
| 268 x 16 / 256 mm | Nerez brúsený    | 17-08872746 |
| 332 x 16 / 320 mm | Nerez            | 17-08872946 |
| 460 x 16 / 448 mm | Nerez            | 17-08873346 |
| 780 x 16 / 768 mm | Nerez            | 17-08874046 |



**ÚCHYTKA**

| Rozmer            | Povrchová úprava   | Obj. číslo  |
|-------------------|--------------------|-------------|
| 202 x 29 / 160 mm | Hliník matný chróm | 17-08875046 |
| 202 x 29 / 160 mm | Hliník nerez       | 17-08875047 |



**ÚCHYTKA**

| Rozmer            | Povrchová úprava   | Obj. číslo  |
|-------------------|--------------------|-------------|
| 28 x 28 mm        | Nerez brúsený      | 17-08993019 |
| 28 x 28 mm        | Chróm matný        | 17-08993031 |
| 204 x 28 / 160 mm | Hliník matný chróm | 17-08993543 |

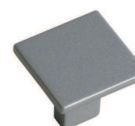

**ÚCHYTKA**

| Rozmer            | Povrchová úprava | Obj. číslo  |
|-------------------|------------------|-------------|
| 188 x 12 / 128 mm | Oceľ             | 17-25210128 |
| 244 x 12 / 184 mm | Oceľ             | 17-25210184 |
| 322 x 12 / 262 mm | Oceľ             | 17-25210262 |
| 394 x 12 / 334 mm | Oceľ             | 17-25210334 |
| 444 x 12 / 384 mm | Oceľ             | 17-25210384 |
| 544 x 12 / 484 mm | Oceľ             | 17-25210484 |
| 571 x 12 / 511 mm | Oceľ             | 17-25210511 |
| 696 x 12 / 636 mm | Oceľ             | 17-25210636 |

**ÚCHYTKA**

| Rozmer            | Povrchová úprava | Obj. číslo  |
|-------------------|------------------|-------------|
| 218 x 14 / 190 mm | Oceľ             | 17-41210190 |
| 508 x 14 / 480 mm | Oceľ             | 17-41210480 |
| 138 x 10 / 128 mm | Nerez brúsený    | 17-42210128 |
| 202 x 10 / 192 mm | Nerez brúsený    | 17-42210192 |
| 234 x 10 / 224 mm | Nerez brúsený    | 17-42210224 |
| 330 x 10 / 320 mm | Nerez brúsený    | 17-42210320 |
| 746 x 10 / 736 mm | Nerez brúsený    | 17-42210736 |

**ÚCHYTKA**

| Rozmer            | Povrchová úprava | Obj. číslo  |
|-------------------|------------------|-------------|
| 172 x 12 / 160 mm | Nerez brúsený    | 17-43210160 |
| 204 x 12 / 192 mm | Nerez brúsený    | 17-43210192 |
| 236 x 12 / 224 mm | Nerez brúsený    | 17-43210224 |
| 332 x 12 / 320 mm | Nerez brúsený    | 17-43210320 |
| 492 x 12 / 480 mm | Nerez brúsený    | 17-43210480 |
| 652 x 12 / 640 mm | Nerez brúsený    | 17-43210640 |

**ÚCHYTKA**

| Rozmer            | Povrchová úprava | Obj. číslo  |
|-------------------|------------------|-------------|
| 142 x 14 / 128 mm | Nerez brúsený    | 71-44210128 |
| 206 x 14 / 192 mm | Nerez brúsený    | 71-44210192 |
| 238 x 14 / 224 mm | Nerez brúsený    | 71-44210224 |
| 462 x 14 / 448 mm | Nerez brúsený    | 71-44210448 |

**ÚCHYTKA**

| Rozmer            | Povrchová úprava | Obj. číslo  |
|-------------------|------------------|-------------|
| 175 x 35 / 160 mm | Chróm / sklo     | 17-51290160 |
| 239 x 35 / 224 mm | Chróm / sklo     | 17-51290224 |
| 335 x 35 / 320 mm | Chróm / sklo     | 17-51290320 |
| 495 x 35 / 480 mm | Chróm / sklo     | 17-51290480 |

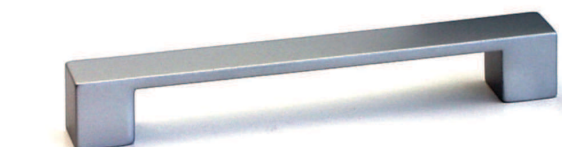
**ÚCHYTKA**

| Rozmer            | Povrchová úprava   | Obj. číslo  |
|-------------------|--------------------|-------------|
| 195 x 24 / 160 mm | Hliník matný chróm | 17-63454631 |

**VEŠIAK**

| Rozmer     | Povrchová úprava | Obj. číslo  |
|------------|------------------|-------------|
| 86 x 17 mm | Chróm            | 17-75031029 |
| 86 x 17 mm | Chróm matný      | 17-75031030 |
| 39 x 17 mm | Chróm            | 17-75031129 |
| 39 x 17 mm | Chróm matný      | 17-75031130 |

**VEŠIAK**

| Rozmer          | Povrchová úprava | Obj. číslo  |
|-----------------|------------------|-------------|
| 30 x 30 x 26 mm | Nerez            | 17-75041017 |
| 35 x 30 x 42 mm | Nerez            | 17-75041217 |

**VEŠIAK**

| Rozmer      | Povrchová úprava | Obj. číslo  |
|-------------|------------------|-------------|
| 155 x 17 mm | Nerez            | 17-75060019 |
| 155 x 17 mm | Chróm matný      | 17-75060030 |
| 80 x 17 mm  | Nerez            | 17-75060119 |
| 80 x 17 mm  | Chróm matný      | 17-75060130 |

**VEŠIAK**

| Rozmer           | Povrchová úprava | Obj. číslo  |
|------------------|------------------|-------------|
| 150 x 53 / 22 mm | Chróm            | 17-75070129 |
| 150 x 53 / 22 mm | Chróm matný      | 17-75070130 |

**VEŠIAK**

| Rozmer      | Povrchová úprava | Obj. číslo  |
|-------------|------------------|-------------|
| 175 x 18 mm | Hliník           | 17-75090047 |
| 72 x 18 mm  | Hliník           | 17-75090147 |



**VEŠIAK**

| Rozmer      | Povrchová úprava | Obj. číslo  |
|-------------|------------------|-------------|
| 180 x 55 mm | Hliník           | 17-75091047 |
| 80 x 55 mm  | Hliník           | 17-75091147 |

**VEŠIAK**

| Rozmer      | Povrchová úprava | Obj. číslo  |
|-------------|------------------|-------------|
| 142 x 20 mm | Nerez škrabaný   | 17-75105017 |
| 60 x 20 mm  | Nerez škrabaný   | 17-75105117 |

**VEŠIAK**

| Rozmer          | Povrchová úprava | Obj. číslo  |
|-----------------|------------------|-------------|
| 90 x 90 / 66 mm | Nerez            | 17-75106019 |
| 90 x 90 / 66 mm | Chróm matný      | 17-75106030 |

**VEŠIAK**

| Rozmer      | Povrchová úprava | Obj. číslo  |
|-------------|------------------|-------------|
| 114 x 90 mm | Chróm            | 17-75626029 |
| 114 x 90 mm | Chróm matný      | 17-75626030 |
| 45 x 58 mm  | Chróm            | 17-75626129 |
| 45 x 58 mm  | Chróm matný      | 17-75626130 |

**VEŠIAK**

| Rozmer              | Povrchová úprava | Obj. číslo  |
|---------------------|------------------|-------------|
| 217 x 445 x d 15 mm | Nerez škrabaný   | 17-75900017 |



**ÚCHYTKA**

| Rozmer            | Povrchová úprava | Obj. číslo  |
|-------------------|------------------|-------------|
| 318 x 14 / 290 mm | Nerez škrabaný   | 17-85412102 |



**ÚCHYTKA**

| Rozmer            | Povrchová úprava | Obj. číslo  |
|-------------------|------------------|-------------|
| 172 x 12 / 160 mm | Chróm matný      | 17-85452301 |
| 332 x 12 / 320 mm | Chróm matný lak. | 17-85452303 |
| 812 x 12 / 800 mm | Chróm matný      | 17-85452308 |
| 812 x 12 / 800 mm | Chróm zamak      | 17-85452908 |



**ÚCHYTKA**

| Rozmer                 | Povrchová úprava | Obj. číslo  |
|------------------------|------------------|-------------|
| 224 x 8 / 192 mm       | Nerez matný      | 17-85472101 |
| 224 x 8 / 192 mm       | Nerez matný      | 17-85472111 |
| 352 x 8 / 160 & 320 mm | Nerez matný      | 17-85473103 |

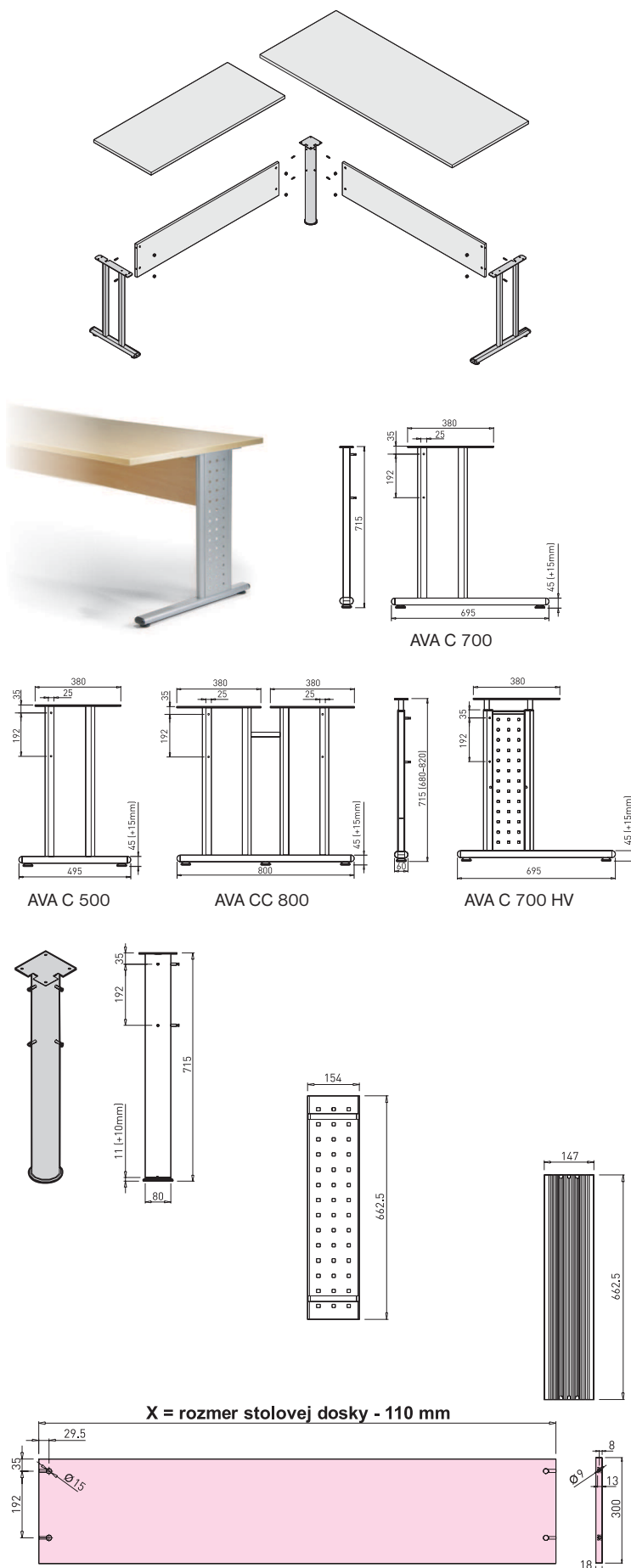

**4.1 SYSTÉM CHRÁT**

Na vyžiadanie vám radi zašleme samostatný katalóg nábytkových nôh a podnoží.

**SYSTÉM CHRÁT**

Systém chrát predstavuje spôsob vzájomného prepojenia nôh perforovanými kovovými chrátami alebo chrátami z DTD. Určený je na stolové dosky s hrúbkou nad 24 mm.

**NOHY AVA**

| Typ          | Šírka  | Výška        | Povrchová úprava | Obj. číslo |
|--------------|--------|--------------|------------------|------------|
| AVA C 700    | 695 mm | 715 mm       | Šedá RAL 9006 G  | 80-30172   |
| AVA C 500    | 495 mm | 715 mm       | Šedá RAL 9006 G  | 80-30173   |
| AVA CC 800   | 800 mm | 715 mm       | Šedá RAL 9006 G  | 80-30251   |
| AVA C 700 HV | 695 mm | 680 - 820 mm | Šedá RAL 9006 G  | 80-30252   |

**NOHA UHLOVÁ**

| Typ      | Výška  | Povrchová úprava | Obj. číslo |
|----------|--------|------------------|------------|
| ∅ 80/90° | 715 mm | Šedá RAL 9006 G  | 80-30174   |

**VLOŽKA KOVOVÁ S PERFORÁCIU**

| Rozmery        | Povrchová úprava | Obj. číslo |
|----------------|------------------|------------|
| 662,5 x 154 mm | Šedá RAL 9006 G  | 80-30220   |

**VLOŽKA PLASTOVÁ**

| Rozmery        | Povrchová úprava | Obj. číslo |
|----------------|------------------|------------|
| 662,5 x 147 mm | RAL 7015         | 80-30219   |

**CHRÁT Z DTD**

## 4.2 SYSTÉM SPOJKA

### SYSTÉM SPOJKA

Systém spojka predstavuje spôsob vzájomného prepojenia nôh spojkami rôznych dĺžok, čím vznikne stabilná kovová podnož. Spojky sú určené na rôzne dĺžky stolových dosiek (800 – 2000 mm) s hrúbkou nad 24 mm.

### NOHY COMO

| Typ           | Šírka  | Výška        | Povrchová úprava | Obj. číslo |
|---------------|--------|--------------|------------------|------------|
| COMO C 700    | 695 mm | 715 mm       | Šedá RAL 9006 G  | 80-30145   |
| COMO C 500    | 495 mm | 715 mm       | Šedá RAL 9006 G  | 80-30143   |
| COMO C 700 HV | 695 mm | 680 – 820 mm | Šedá RAL 9006 G  | 80-30182   |
| COMO C 500 HV | 495 mm | 680 – 820 mm | Šedá RAL 9006 G  | 80-30057   |

### NOHY TEMPO

| Typ          | Šírka  | Výška  | Povrchová úprava | Obj. číslo |
|--------------|--------|--------|------------------|------------|
| TEMPO T 600  | 625 mm | 715 mm | Šedá RAL 9006 G  | 80-30000   |
| TEMPO T 400  | 425 mm | 715 mm | Šedá RAL 9006 G  | 80-30002   |
| TEMPO TT 800 | 810 mm | 715 mm | Šedá RAL 9006 G  | 80-30006   |

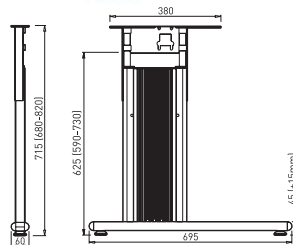
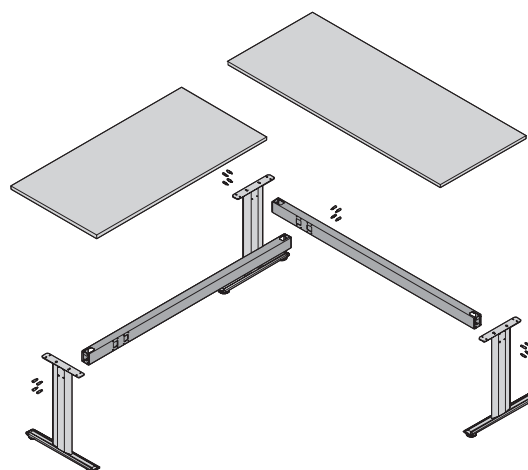

COMO C 700 HV

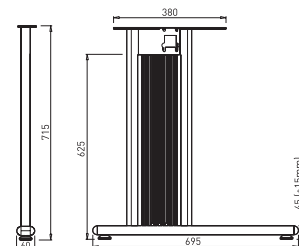

COMO C 700

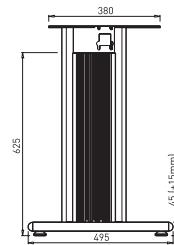

COMO C 500

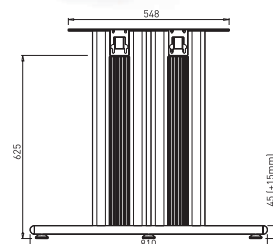

TEMPO TT 800

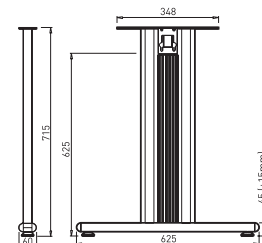

TEMPO T 600

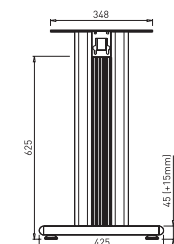

TEMPO T 400

# NOHY, PODNOŽE A KOLIESKA

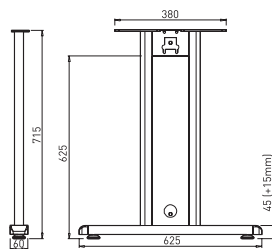

WORK T 600

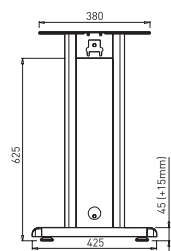

WORK T 400

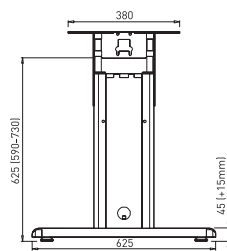

WORK T 600 HV

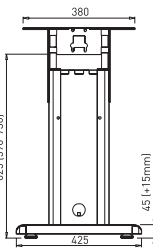

WORK T 400 HV

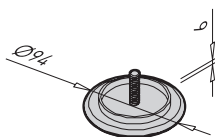
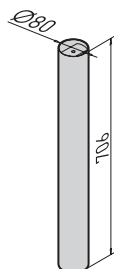
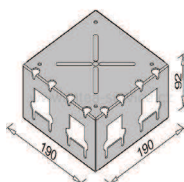
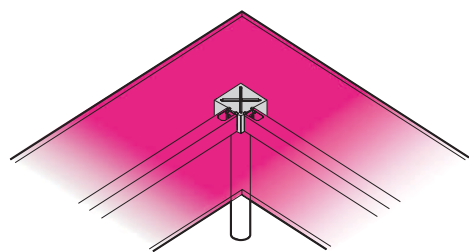
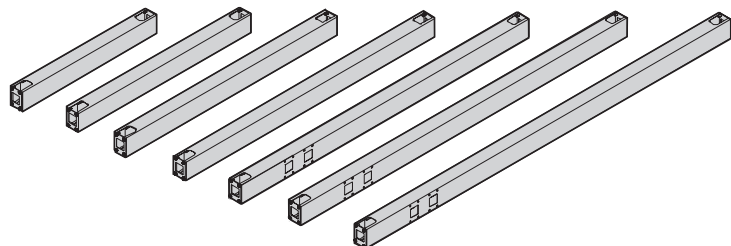

## NOHY WORK

| Typ           | Šírka  | Výška        | Povrchová úprava | Obj. číslo |
|---------------|--------|--------------|------------------|------------|
| WORK T 600    | 625 mm | 715 mm       | Šedá RAL 9006 G  | 80-30199   |
| WORK T 400    | 425 mm | 715 mm       | Šedá RAL 9006 G  | 80-30198   |
| WORK T 600 HV | 625 mm | 680 - 820 mm | Šedá RAL 9006 G  | 80-30201   |
| WORK T 400 HV | 425 mm | 680 - 820 mm | Šedá RAL 9006 G  | 80-30200   |

## SPOJKY

| Typ  | Dĺžka   | Povrchová úprava | Obj. číslo |
|------|---------|------------------|------------|
| 800  | 703 mm  | Šedá RAL 9006 G  | 80-30014   |
| 1000 | 903 mm  | Šedá RAL 9006 G  | 80-30015   |
| 1200 | 1103 mm | Šedá RAL 9006 G  | 80-30017   |
| 1400 | 1303 mm | Šedá RAL 9006 G  | 80-30019   |
| 1600 | 1503 mm | Šedá RAL 9006 G  | 80-30021   |
| 1800 | 1703 mm | Šedá RAL 9006 G  | 80-30022   |
| 2000 | 1903 mm | Šedá RAL 9006 G  | 80-30023   |

## DOSKA NOSNÁ

| Typ | Určenie       | Obj. číslo |
|-----|---------------|------------|
| 90° | SYSTEM SPOJKA | 80-30879   |

## NOHA UHLOVÁ

| Typ        | Výška  | Povrchová úprava | Obj. číslo |
|------------|--------|------------------|------------|
| TERRA ø 80 | 706 mm | Šedá RAL 9006 G  | 80-30115   |

## ČAP REGULAČNÝ

| Typ  | Priemer | Povrchová úprava | Obj. číslo |
|------|---------|------------------|------------|
| ø 80 | 94 mm   | Plast RAL 7015   | 80-30276   |



### 4.3 SYSTÉM RÁM

#### SYSTÉM RÁM

Systém rám predstavuje spôsob vzájomného prepojenia nôh priečnikmi rôznych dĺžok. Priečniky sú určené na rôzne dĺžky stolových dosiek (600 – 2000 mm) s hrúbkou aj pod 24 mm.

#### NOHY CUBO 50

| Typ         | Šírka  | Výška  | Povrchová úprava | Obj. číslo |
|-------------|--------|--------|------------------|------------|
| CUBO 50/800 | 780 mm | 715 mm | Šedá RAL 9006 G  | 80-30228   |
| CUBO 50/600 | 580 mm | 715 mm | Šedá RAL 9006 G  | 80-30229   |

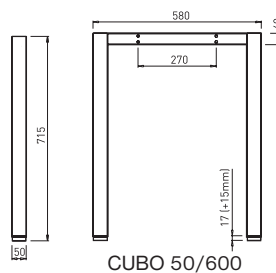

CUBO 50/600

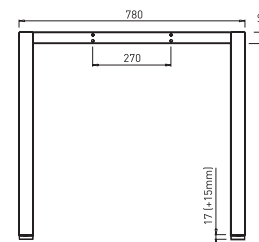

CUBO 50/800

#### NOHY OXO 50

| Typ        | Šírka  | Výška  | Povrchová úprava | Obj. číslo |
|------------|--------|--------|------------------|------------|
| OXO 50/800 | 780 mm | 715 mm | Šedá RAL 9006 G  | 80-30221   |
| OXO 50/600 | 580 mm | 715 mm | Šedá RAL 9006 G  | 80-30187   |

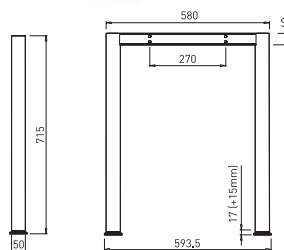

OXO 50/600

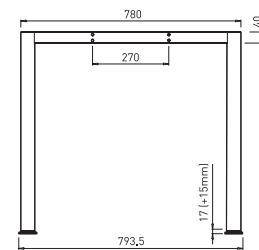

OXO 50/800

#### PRIEČNIKY

| Typ         | Dĺžka     | Povrchová úprava | Obj. číslo |
|-------------|-----------|------------------|------------|
| 600         | 510 mm    | Šedá RAL 9006 G  | 80-30232   |
| 800         | 710 mm    | Šedá RAL 9006 G  | 80-30234   |
| 1000        | 910 mm    | Šedá RAL 9006 G  | 80-30236   |
| 1200        | 1110 mm   | Šedá RAL 9006 G  | 80-30238   |
| 1400        | 1310 mm   | Šedá RAL 9006 G  | 80-30240   |
| 1600        | 1510 mm   | Šedá RAL 9006 G  | 80-30242   |
| 1800        | 1710 mm   | Šedá RAL 9006 G  | 80-30244   |
| 2000        | 1910 mm   | Šedá RAL 9006 G  | 80-30246   |
| 900 – 1400  | 810–1310  | Šedá RAL 9006 G  | 80-30376   |
| 1500 – 2000 | 1410–1910 | Šedá RAL 9006 G  | 80-30377   |

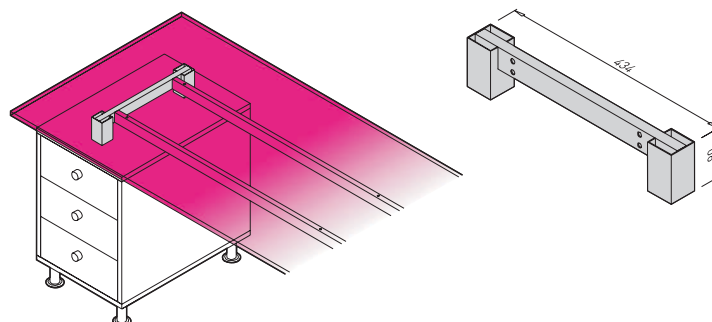
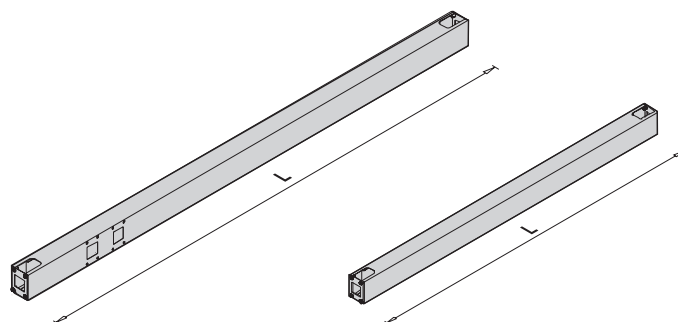

#### NOSNÍK ZÁSUVKY

| Typ  | Šírka  | Výška | Povrchová úprava | Obj. číslo |
|------|--------|-------|------------------|------------|
| CUBO | 434 mm | 80 mm | Šedá RAL 9006 G  | 80-30092   |

## 4.4 SAMOSTATNÉ NOHY

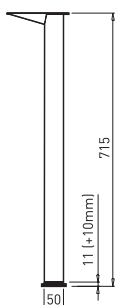

FIFTY

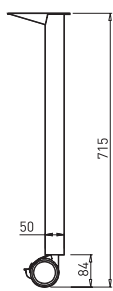

FIFTY K

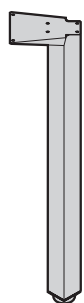

FIFTY CUBO

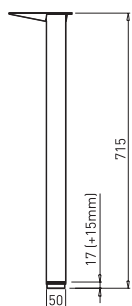

FIFTY CUBO K

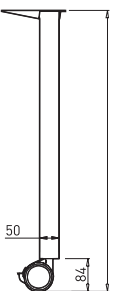
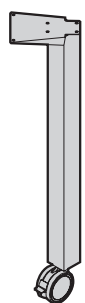

EIGHTY P

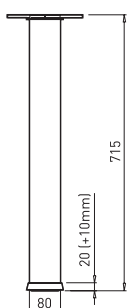

EIGHTY AL

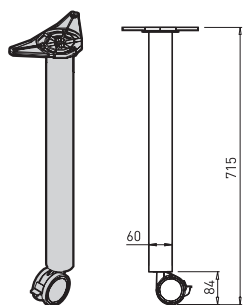

SIXTY K

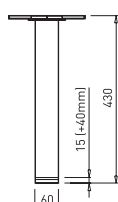

SIXTY CLUB

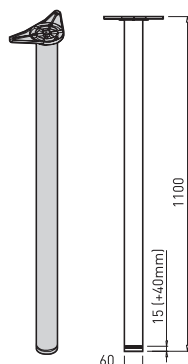

SIXTY BAR

### NOHY FIFTY

| Typ     | Priemer | Výška  | Povrchová úprava | Obj. číslo |
|---------|---------|--------|------------------|------------|
| FIFTY   | 50 mm   | 715 mm | Šedá RAL 9006 G  | 80-30052   |
| FIFTY K | 50 mm   | 715 mm | Šedá RAL 9006 G  | 80-30055   |

### NOHY CUB IN

| Typ          | Šírka | Výška  | Povrchová úprava | Obj. číslo |
|--------------|-------|--------|------------------|------------|
| FIFTY CUBO   | 50 mm | 715 mm | Šedá RAL 9006 G  | 80-30385   |
| FIFTY CUBO K | 50 mm | 715 mm | Šedá RAL 9006 G  | 80-30387   |

### NOHY EIGHTY

| Typ       | Priemer | Výška  | Povrchová úprava | Obj. číslo |
|-----------|---------|--------|------------------|------------|
| EIGHTY P  | 80 mm   | 715 mm | Šedá RAL 9006 G  | 80-30080   |
| EIGHTY AL | 80 mm   | 715 mm | Šedá RAL 9006 G  | 80-30078   |

### NOHA STOLOVÁ

**PRIAZNIVÁ  
CENA** 1

| Priemer | Výška  | Povrchová úprava | Obj. číslo  |
|---------|--------|------------------|-------------|
| 60 mm   | 710 mm | chróm            | 24-33112060 |
| 60 mm   | 710 mm | čierna           | 24-33112062 |
| 60 mm   | 710 mm | RAL 9006         | 24-33112061 |

### NOHY SIXTY

| Typ        | Priemer | Výška        | Povrchová úprava | Obj. číslo |
|------------|---------|--------------|------------------|------------|
| SIXTY K    | 60 mm   | 715 mm       | Šedá RAL 9006 G  | 80-30018   |
| SIXTY CLUB | 60 mm   | 430 - 470 mm | Šedá RAL 9006 G  | 80-30398   |
| SIXTY BAR  | 60 mm   | 1100 mm      | Šedá RAL 9006 G  | 80-30132   |

## 4.5 SAMOSTATNÉ PODNOŽE

### PODNOŽ TERRA STŤPIK TERRA

| Typ              | Výška        | Povrchová úprava | Obj. číslo |
|------------------|--------------|------------------|------------|
| TERRA<br>ø 80    | 706 mm       | Šedá RAL 9006 G  | 80-30115   |
| TERRA<br>ø 50    | 706 mm       | Šedá RAL 9006 G  | 80-30098   |
| TERRA<br>ø 80 HV | 540 - 820 mm | Šedá RAL 9006 G  | 80-30009   |
| TERRA<br>50x50   | 706 mm       | Šedá RAL 9006 G  | 80-30630   |

### DOSKA TERRA

| Rozmery      | Hrúbka | Povrchová úprava | Obj. číslo |
|--------------|--------|------------------|------------|
| 200 x 200 mm | 3 mm   | Šedá RAL 9006 G  | 80-30120   |
| 330 x 330 mm | 3 mm   | Šedá RAL 9006 G  | 80-30162   |

### TANIER TERRA

| Typ            | Priemer | Hrúbka | Povrchová úprava | Obj. číslo |
|----------------|---------|--------|------------------|------------|
| TERRA<br>ø 400 | 395 mm  | 6 mm   | Šedá RAL 9006 G  | 80-30117   |
| TERRA<br>ø 500 | 495 mm  | 6 mm   | Šedá RAL 9006 G  | 80-30118   |
| TERRA<br>ø 600 | 595 mm  | 6 mm   | Šedá RAL 9006 G  | 80-30119   |
| 400 x 400 mm   |         | 6 mm   | Šedá RAL 9006 G  | 80-30632   |

### DRŽIAK SKLA

| Priemer | Povrchová úprava | Obj. číslo |
|---------|------------------|------------|
| 80 mm   | Hliník           | 80-20675   |

### ČAP REGULAČNÝ

| Typ  | Priemer | Povrchová úprava | Obj. číslo |
|------|---------|------------------|------------|
| ø 50 | 63,5 mm | Plast RAL 7015   | 80-30275   |
| ø 80 | 94 mm   | Plast RAL 7015   | 80-30276   |

### PODNOŽ PIEFA

| Typ              | Priemer    | Výška  | Povrchová úprava | Obj. číslo |
|------------------|------------|--------|------------------|------------|
| PIEFA<br>BAROKO  | 450 mm     | 730 mm | Čierna RAL 9005  | 80-60049   |
| PIEFA<br>KRUH    | 450 mm     | 725 mm | Čierna RAL 9005  | 80-60050   |
| PIEFA<br>ŠTVOREC | 400x400 mm | 720 mm | Čierna RAL 9005  | 80-60051   |

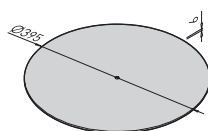
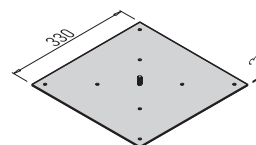
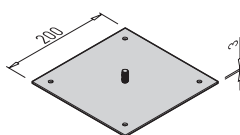
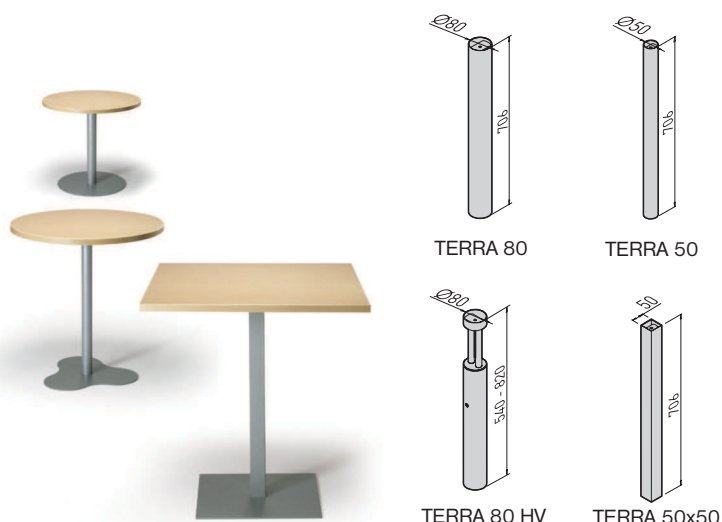

TERRA ø 400

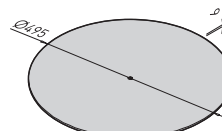

TERRA ø 500

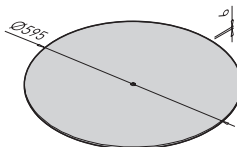

TERRA ø 600

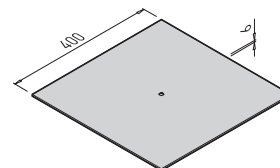

400 x 400 mm

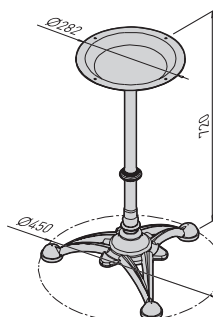
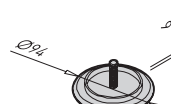
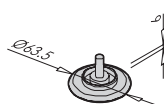

PIEFA BAROKO

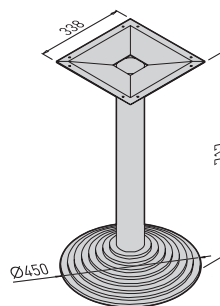

PIEFA KRUH

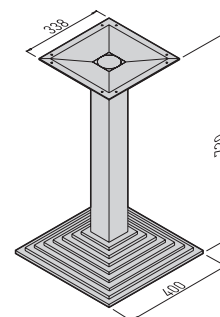

PIEFA ŠTVOREC

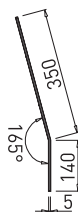
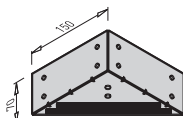
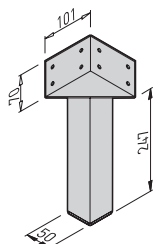
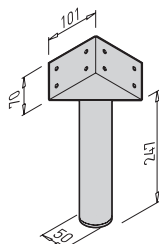
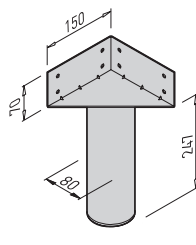
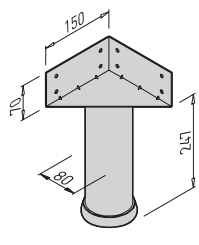
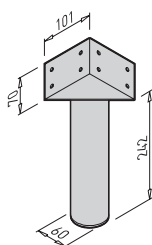
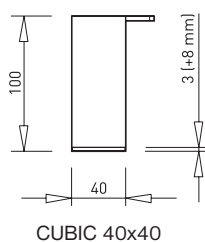
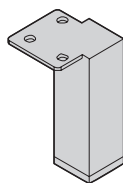
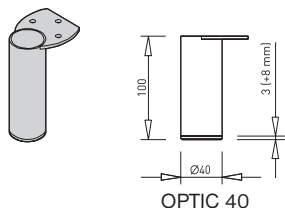
**4.6 SAMOSTATNÉ NOŽIČKY**

**NOHY OPTIC**

| Typ           | Priemer | Výška  | Povrchová úprava   | Obj. číslo |
|---------------|---------|--------|--------------------|------------|
| OPTIC<br>ø 40 | 40 mm   | 100 mm | Šedá<br>RAL 9006 G | 80-30699   |

**NOHY CUBIC**

| Typ            | Šírka | Výška  | Povrchová úprava   | Obj. číslo |
|----------------|-------|--------|--------------------|------------|
| CUBIC<br>40x40 | 40 mm | 100 mm | Šedá<br>RAL 9006 G | 80-30643   |

**NOHY SILK**

| Typ             | Priemer     | Výška  | Povrchová úprava   | Obj. číslo |
|-----------------|-------------|--------|--------------------|------------|
| SILK ø 60       | 60 mm       | 242 mm | Šedá<br>RAL 9006 G | 80-30183   |
| SILK<br>ø 80 AL | 80 mm       | 247 mm | Šedá<br>RAL 9006 G | 80-30209   |
| SILK ø 80 P     | 80 mm       | 247 mm | Šedá<br>RAL 9006 G | 80-30121   |
| SILK ø 50 P     | 50 mm       | 247 mm | Šedá<br>RAL 9006 G | 80-30208   |
| SILK 50<br>CUBO | 50x50<br>mm | 247 mm | Šedá<br>RAL 9006 G | 80-30644   |

**UHOLNÍK SILK**

| Povrchová úprava | Obj. číslo |
|------------------|------------|
| Šedá RAL 9006 G  | 80-30180   |

**NOSNÍK OPERADLA SILK**

| Povrchová úprava | Obj. číslo |
|------------------|------------|
| Šedá RAL 9006 G  | 80-30091   |

## 4.7 SOKLOVÉ NOŽIČKY

### NOHA SOKLOVÁ PLASTOVÁ ČIERNA



| Výška sokla | Obj. číslo  |
|-------------|-------------|
| 150 mm      | 71-63745371 |
| 120 mm      | 71-63745344 |
| 100 mm      | 71-63745326 |
| 80 mm       | 71-63745308 |

\*otočný spodný tanier

### NOHA SOKLOVÁ PLASTOVÁ ČIERNA



| Výška sokla | Obj. číslo  |
|-------------|-------------|
| 150 mm      | 24-22101004 |
| 120 mm      | 24-22101003 |
| 100 mm      | 24-22101001 |

### DRŽIAK SOKLA



| Pre sokle   | Obj. číslo  |
|-------------|-------------|
| 150 mm      | 71-63719906 |
| 80 - 120 mm | 71-63745906 |

### DRŽIAK SOKLA



| Pre sokle   | Obj. číslo  |
|-------------|-------------|
| 80 - 120 mm | 24-22901001 |

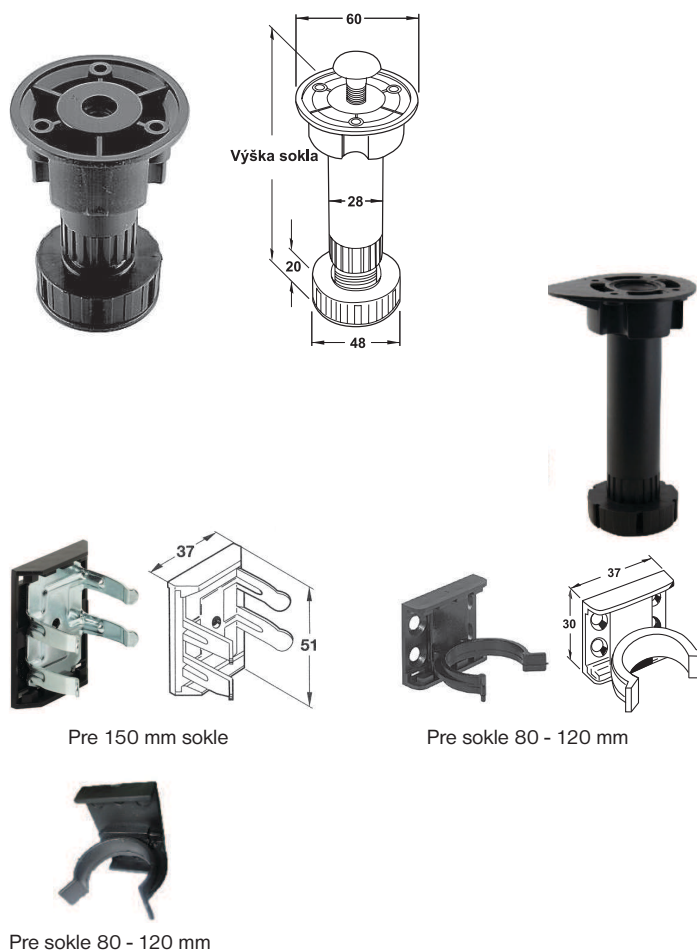

NOHY, PODNOŽE A KOLIESKA

## 4.8 NOŽIČKY NÁBYTKOVÉ

### NOŽIČKA Ø 35

| Výška  | Povrchová úprava | Obj. číslo  |
|--------|------------------|-------------|
| 100 mm | Hliník           | 17-23151031 |
| 150 mm | Hliník           | 17-23151531 |
| 200 mm | Hliník           | 17-23152031 |

### NOŽIČKA Ø 50

| Výška  | Povrchová úprava | Obj. číslo |
|--------|------------------|------------|
| 100 mm | Hliník           | 62-5109    |
| 150 mm | Hliník           | 62-5159    |
| 180 mm | Hliník           | 62-5189    |

### NOŽIČKA Ø 32

| Výška  | Povrchová úprava | Obj. číslo |
|--------|------------------|------------|
| 100 mm | Chróm            | 62-3925    |
| 100 mm | Nikel satén      | 62-1511    |

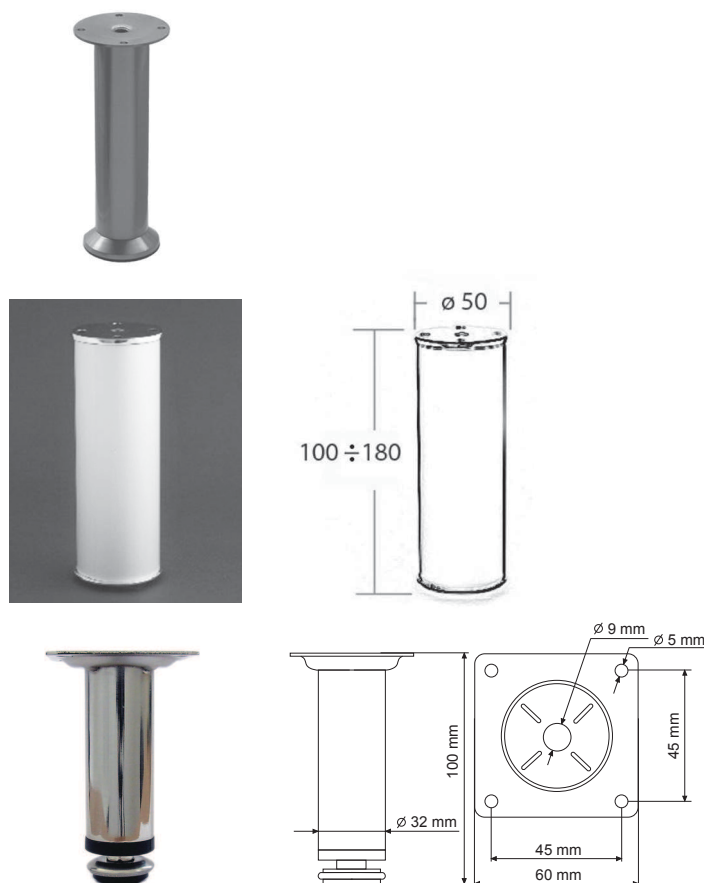

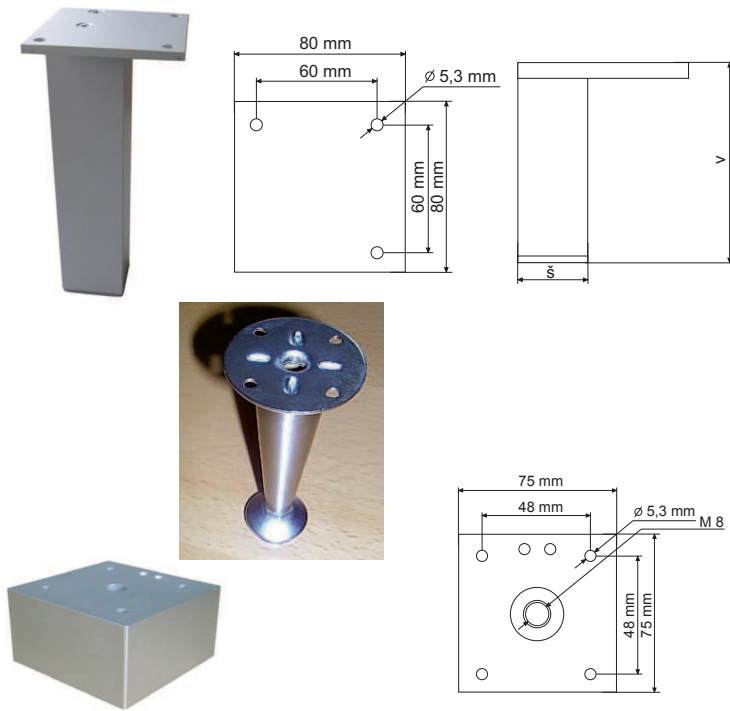
**NOŽIČKA 45 x 45**

| Výška  | Povrchová úprava | Obj. číslo |
|--------|------------------|------------|
| 80 mm  | Hliník           | 62-2018    |
| 100 mm | Hliník           | 62-2017    |
| 120 mm | Hliník           | 62-2019    |
| 160 mm | Hliník           | 62-2016    |

**NOŽIČKA Ø 40**

| Výška  | Povrchová úprava | Obj. číslo |
|--------|------------------|------------|
| 100 mm | Nikel satén      | 62-1925    |
| 100 mm | CR               | 62-0925    |

**NOŽIČKA PLASTOVÁ 75 x 75**

| Výška | Povrchová úprava | Obj. číslo |
|-------|------------------|------------|
| 50 mm | Hliník           | 62-2020    |

**4.9 KOLIESKA**

**KOLIESKO DVOJITÉ BEZ BRZDY**

| Priemer | Nosnosť | Montáž    | Povrchová úprava | Obj. číslo  |
|---------|---------|-----------|------------------|-------------|
| 35 mm   | 25 kg   | Závit M8  | Čierna           | 71-66007304 |
| 35 mm   | 25 kg   | Platnička | Čierna           | 71-66007301 |
| 40 mm   | 30 kg   | Závit M8  | Čierna           | 71-66050333 |
| 40 mm   | 30 kg   | Platnička | Čierna           | 71-66007311 |
| 50 mm   | 50 kg   | Platnička | Čierna           | 71-66007321 |

| Priemer | Montáž    | Povrchová úprava | Obj. číslo  |
|---------|-----------|------------------|-------------|
| 40 mm   | Platnička | čierna           | 24-06101040 |
| 50 mm   | Platnička | čierna           | 24-06101050 |

**KOLIESKO DVOJITÉ S BRZDOU**

| Priemer | Nosnosť | Montáž    | Povrchová úprava | Obj. číslo  |
|---------|---------|-----------|------------------|-------------|
| 50 mm   | 50 kg   | Platnička | Čierna           | 71-66008321 |

**KOLESO BEZ BRZDY**

| Priemer | Nosnosť | Montáž    | Povrchová úprava   | Obj. číslo  |
|---------|---------|-----------|--------------------|-------------|
| 75 mm   | 60 kg   | Platnička | Oceľ galvanizovaná | 71-66306920 |

**KOLESO S BRZDOU**

| Priemer | Nosnosť | Montáž    | Povrchová úprava   | Obj. číslo  |
|---------|---------|-----------|--------------------|-------------|
| 75 mm   | 60 kg   | Platnička | Oceľ galvanizovaná | 71-66316920 |

**KOLESO DVOJITÉ S BRZDOU**

| Priemer | Nosnosť | Montáž    | Povrchová úprava | Obj. číslo |
|---------|---------|-----------|------------------|------------|
| 75 mm   | 50 kg   | Platnička | Plast šedý       | 80-20677   |

## 4.10 KLZÁKY

### KLZÁK SKRUTKOVACÍ PLASTOVÝ

| Výška | Povrchová úprava | Obj. číslo |
|-------|------------------|------------|
| 17 mm | Čierna           | 62-2051    |
| 27 mm | Čierna           | 62-2050    |

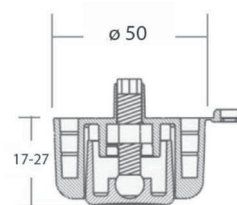
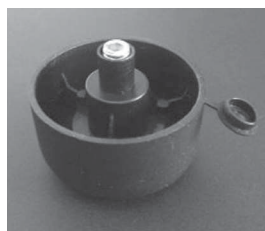

## 4.11 SOKLE A SOKLOVÉ TESNENIE

### SOKEL

| Výška  | Povrchová úprava | Obj. číslo |
|--------|------------------|------------|
| 100 mm | ALU fólia        | 02-282785  |
|        | ALU papier       | 02-276748  |
| 150 mm | ALU fólia        | 02-283770  |
|        | ALU papier       | 02-276708  |

dĺžka 4m



### PRÍCHYTKA SOKLA

|  | Obj. číslo |
|--|------------|
|  | 02-269733  |

### SOKLOVÉ TESNENIE

| Šírka | Obj. číslo |
|-------|------------|
| 16 mm | 80-6930    |
| 18 mm | 80-6845    |

dĺžka 5 m



### TESNIACE LIŠTY K PRACOVNÝM DOSKÁM

| Farba  | Dĺžka | Obj. číslo |
|--------|-------|------------|
| Nerez  | 5 m   | 80-1083    |
| Hliník | 5 m   | 80-1084    |
| Čierna | 5 m   | 80-1085    |
| Biela  | 5 m   | 80-1096    |

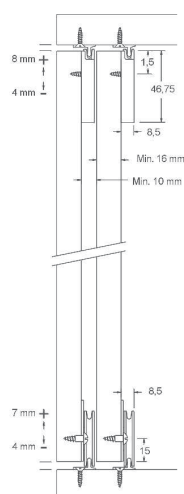
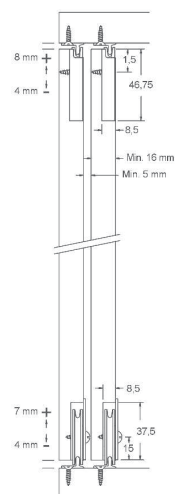
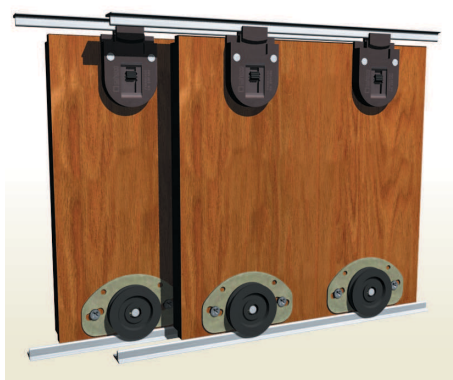
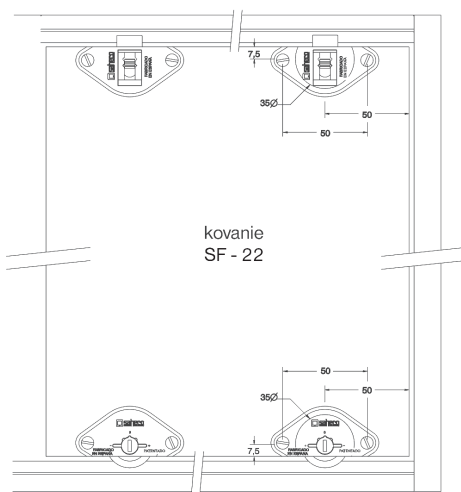
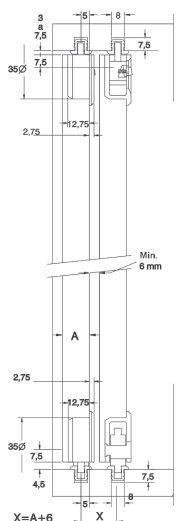
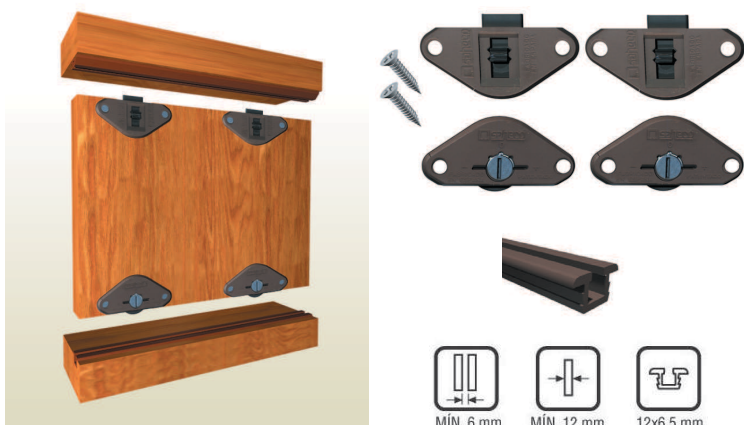

**5.1 SYSTÉM POSUVNÝCH DVERÍ S DOLNÝM VEDENÍM**

Na vyžiadanie vám radi zašleme samostatný katalóg kovania na posuvné dvere.

**KOVANIE SF-22**

| Typ   | Nosnosť  | Hrúbka dverí | Povrchová úprava | Obj. číslo |
|-------|----------|--------------|------------------|------------|
| SF-22 | do 22 kg | od 12 mm     | Šedá             | 99-002200  |

**PROFIL PLASTOVÝ**

| Typ   | Dĺžka | Povrchová úprava | Obj. číslo |
|-------|-------|------------------|------------|
| SF-22 | 3 m   | Béžová           | 99-002230  |
| SF-22 | 3 m   | Tmavohnedá       | 99-002231  |

**KOVANIE SF-25**

| Typ   | Nosnosť  | Hrúbka dverí | Povrchová úprava | Obj. číslo |
|-------|----------|--------------|------------------|------------|
| SF-25 | do 25 kg | od 16 mm     | Čierna           | 99-002500  |

**PROFIL HLINÍKOVÝ**

| Typ   | Dĺžka | Povrchová úprava | Obj. číslo |
|-------|-------|------------------|------------|
| SF-25 | 2 m   | Zlatá            | 99-002520  |
| SF-25 | 2 m   | Čierna           | 99-002521  |
| SF-25 | 2 m   | Hliník           | 99-002522  |
| SF-25 | 3 m   | Čierna           | 99-002531  |
| SF-25 | 3 m   | Hliník           | 99-002532  |



**KOVANIE SF-51**

| Typ   | Nosnosť  | Hrúbka dverí | Povrchová úprava | Obj. číslo |
|-------|----------|--------------|------------------|------------|
| SF-51 | do 50 kg | od 16 mm     | Zlatá            | 99-005100  |



**PROFIL HLINÍKOVÝ**

| Typ   | Dĺžka | Povrchová úprava | Obj. číslo |
|-------|-------|------------------|------------|
| SF-51 | 2 m   | Zlatá            | 99-005120  |
| SF-51 | 2 m   | Čierna           | 99-005121  |
| SF-51 | 2 m   | Hliník           | 99-005122  |
| SF-51 | 3 m   | Zlatá            | 99-005130  |
| SF-51 | 3 m   | Čierna           | 99-005131  |
| SF-51 | 3 m   | Hliník           | 99-005132  |

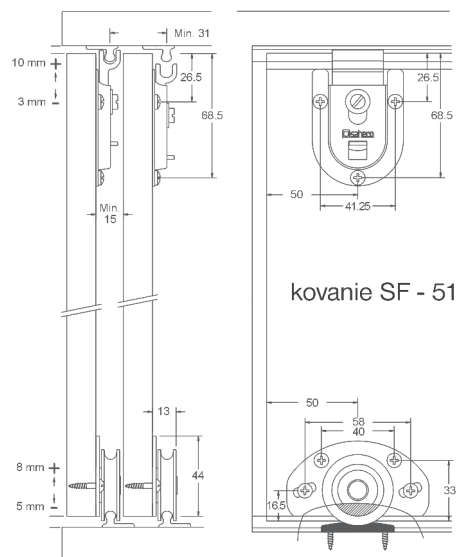

**KOVANIE NA POSUVNÉ DVERE**

# KOVANIE NA POSUVNÉ DVERE

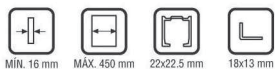
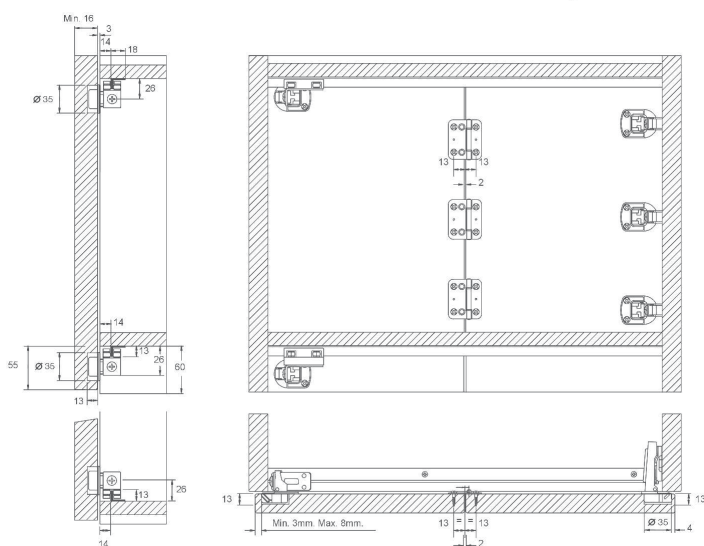
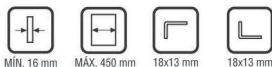

PROFIL HORNÝ

PROFIL DOLNÝ

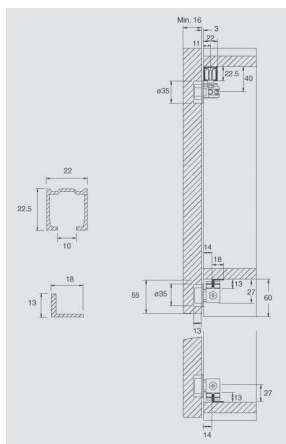

## KOVANIE SF-16D

| Typ    | Nosnosť  | Hrúbka dverí | Povrchová úprava | Obj. číslo |
|--------|----------|--------------|------------------|------------|
| SF-16D | do 16 kg | od 16 mm     | Zinok            | 99-001600  |

## PROFIL HLINÍKOVÝ

| Typ    | Dĺžka | Povrchová úprava | Obj. číslo |
|--------|-------|------------------|------------|
| SF-16D | 2 m   | Hliník           | 99-001620  |
| SF-16D | 3 m   | Hliník           | 99-001630  |

## KOVANIE SF-25D

| Typ    | Nosnosť  | Hrúbka dverí | Povrchová úprava | Obj. číslo |
|--------|----------|--------------|------------------|------------|
| SF-25D | do 25 kg | od 16 mm     | Zinok            | 99-002600  |

## PROFIL HLINÍKOVÝ

| Typ          | Dĺžka | Povrchová úprava | Obj. číslo |
|--------------|-------|------------------|------------|
| SF-25D horný | 2 m   | Hliník           | 99-003120  |
| SF-25D horný | 3 m   | Hliník           | 99-003130  |
| SF-16D dolný | 2 m   | Hliník           | 99-001620  |
| SF-16D dolný | 3 m   | Hliník           | 99-001630  |

## 5.2 SYSTÉM POSUVNÝCH DVERÍ S HORNÝM VEDENÍM

### KOVANIE SF-20

| Typ   | Nosnosť  | Hrúbka dverí | Povrchová úprava | Obj. číslo |
|-------|----------|--------------|------------------|------------|
| SF-20 | do 20 kg | od 16 mm     | Zinok            | 99-002000  |

### PROFIL OCEĽOVÝ

| Typ         | Dĺžka | Povrchová úprava | Obj. číslo |
|-------------|-------|------------------|------------|
| SF-20 horný | 2 m   | Zinok            | 99-3115    |
| SF-20 horný | 3 m   | Zinok            | 99-3116    |

### VODIACI PRVOK PLASTOVÝ

| Typ   | Povrchová úprava | Obj. číslo |
|-------|------------------|------------|
| SF-20 | Čierny           | 99-002052  |

### KOVANIE SF-S60

| Typ              | Nosnosť  | Hrúbka dverí | Povrchová úprava | Obj. číslo |
|------------------|----------|--------------|------------------|------------|
| SF-S60 vnútorné  | do 60 kg | od 19 mm     | Nikel            | 99-006502  |
| SF-S60 vonkajšie | do 60 kg | od 19 mm     | Nikel            | 99-006503  |

### PROFIL HLINÍKOVÝ

| Typ          | Dĺžka | Povrchová úprava | Obj. číslo |
|--------------|-------|------------------|------------|
| SF-S60 horný | 5 m   | Hliník           | 99-006551  |
| SF-S60 horný | 5 m   | Hliník           | 99-006552  |
| SF-S60 dolný | 5 m   | Hliník           | 99-006556  |

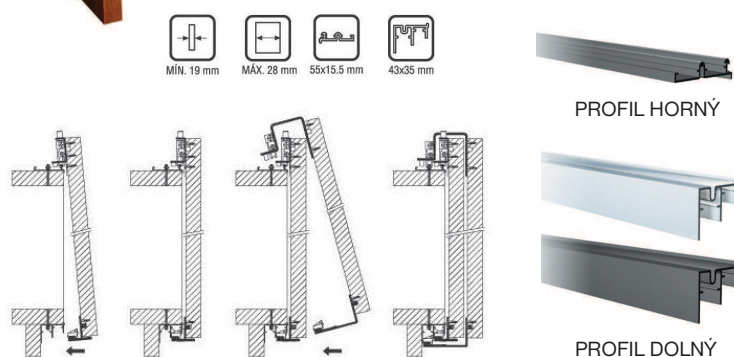
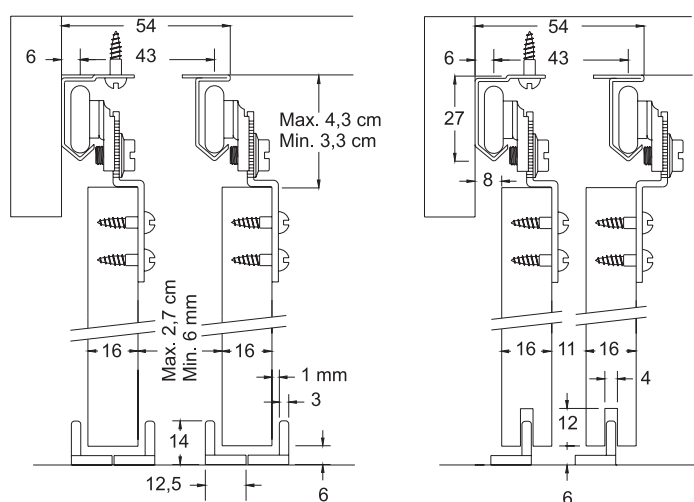
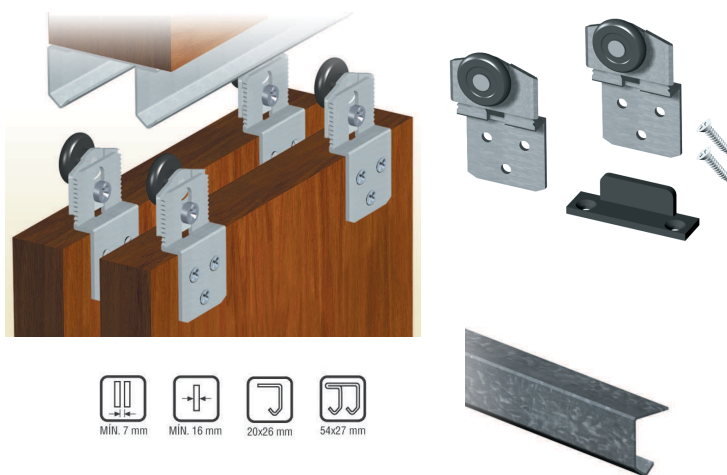

# KOVANIE NA POSUVNÉ DVERE

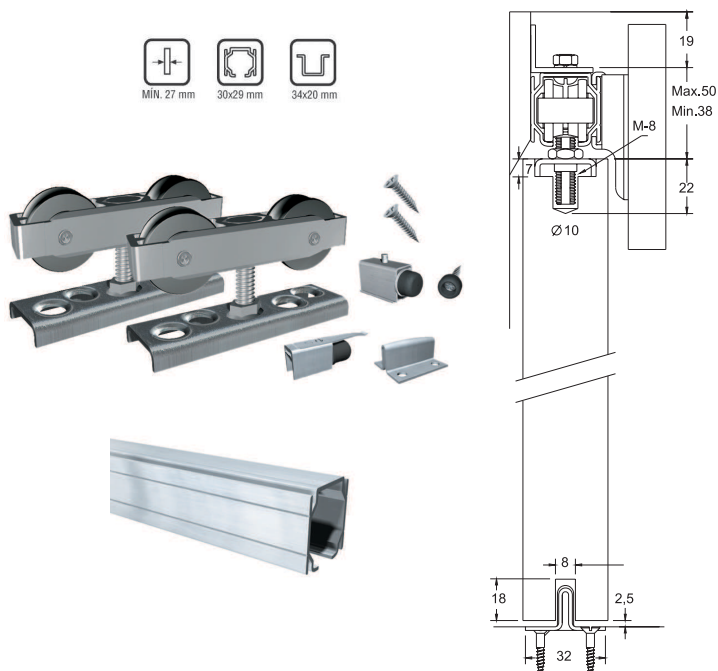
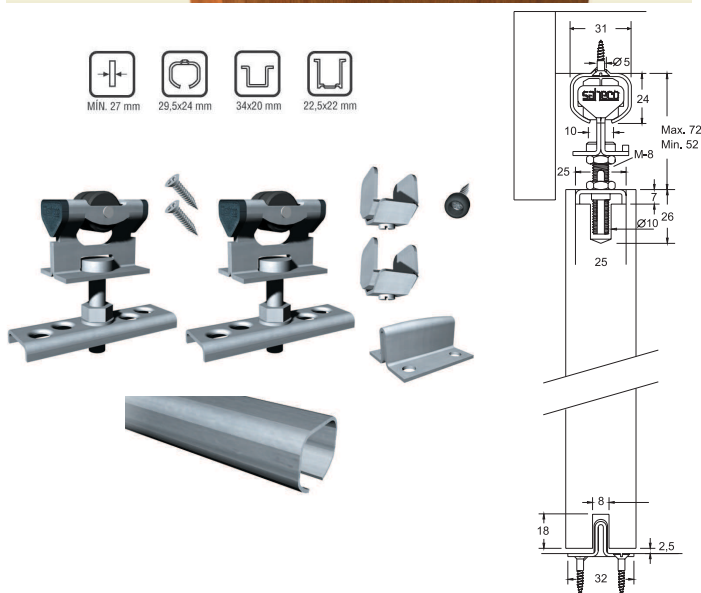

## KOVANIE SF-35, SF-40, SF-75

| Typ   | Nosnosť  | Hrúbka dverí | Povrchová úprava | Obj. číslo |
|-------|----------|--------------|------------------|------------|
| SF-35 | do 35 kg | od 27 mm     | Nikel            | 99-003500  |
| SF-40 | do 40 kg | od 27 mm     | Nikel            | 99-004000  |
| SF-75 | do 75 kg | od 27 mm     | Nikel            | 99-007500  |

## PROFIL OCEĽOVÝ

| Typ         | Dĺžka | Povrchová úprava | Obj. číslo |
|-------------|-------|------------------|------------|
| SF-35/40/75 | 2 m   | Zinok            | 99-3575    |
| SF-35/40/75 | 3 m   | Zinok            | 99-0246    |

## VODIACI PRVOK PLASTOVÝ

| Typ         | Povrchová úprava | Obj. číslo |
|-------------|------------------|------------|
| SF-35/40/75 | Sivý             | 99-004054  |

## KOVANIE SF-A60, SF-A80

| Typ    | Nosnosť  | Hrúbka dverí | Povrchová úprava | Obj. číslo |
|--------|----------|--------------|------------------|------------|
| SF-A60 | do 60 kg | od 27 mm     | Nikel            | 99-006000  |
| SF-A80 | do 80 kg | od 27 mm     | Nikel            | 99-008000  |

## PROFIL HLINÍKOVÝ

| Typ       | Dĺžka | Povrchová úprava | Obj. číslo |
|-----------|-------|------------------|------------|
| SF-A60/80 | 2 m   | Hliník           | 99-006120  |
| SF-A60/80 | 3 m   | Hliník           | 99-006130  |

## VODIACI PRVOK PLASTOVÝ

| Typ       | Povrchová úprava | Obj. číslo |
|-----------|------------------|------------|
| SF-A60/80 | Sivý             | 99-004054  |

**KOVANIE SF-A62D, SF-A63D**

| Typ     | Nosnosť  | Hrúbka dverí | Povrchová úprava | Obj. číslo |
|---------|----------|--------------|------------------|------------|
| SF-A62D | do 35 kg | od 32 mm     | Nikel            | 99-006200  |
| SF-A63D | do 35 kg | od 27 mm     | Nikel            | 99-006300  |
| SF-A64D | do 35 kg | od 27 mm     | Nikel            | 99-006400  |



**PROFIL HLINÍKOVÝ**

| Typ                    | Dĺžka | Povrchová úprava | Obj. číslo |
|------------------------|-------|------------------|------------|
| SF-A60D/<br>A63D horný | 2 m   | Hliník           | 99-006120  |
| SF-A60D/<br>A63D horný | 3 m   | Hliník           | 99-006130  |

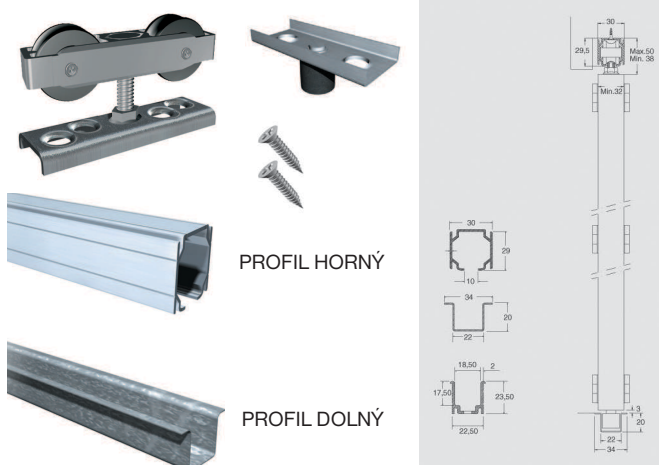

**PROFIL OCEĽOVÝ**

| Typ                    | Dĺžka | Povrchová úprava | Obj. číslo |
|------------------------|-------|------------------|------------|
| SF-A62D/<br>A63D dolný | 3 m   | Zinok            | 99-004130  |
| SF-201/401             | 5 m   | Zinok            | 99-004150  |

**KOVANIE SF-41D, SF-42D, SF-43D**

| Typ    | Nosnosť  | Hrúbka dverí | Povrchová úprava | Obj. číslo |
|--------|----------|--------------|------------------|------------|
| SF-41D | do 40 kg | od 32 mm     | Nikel            | 99-004100  |
| SF-42D | do 40 kg | od 27 mm     | Nikel            | 99-004200  |
| SF-43D | do 40 kg | od 27 mm     | Nikel            | 99-004300  |



**PROFIL OCEĽOVÝ**

| Typ                     | Dĺžka | Povrchová úprava | Obj. číslo |
|-------------------------|-------|------------------|------------|
| S-35D/40D/<br>75D horný | 2 m   | Zinok            | 99-3575    |
| S-35D/40D/<br>75D horný | 3 m   | Zinok            | 99-0246    |

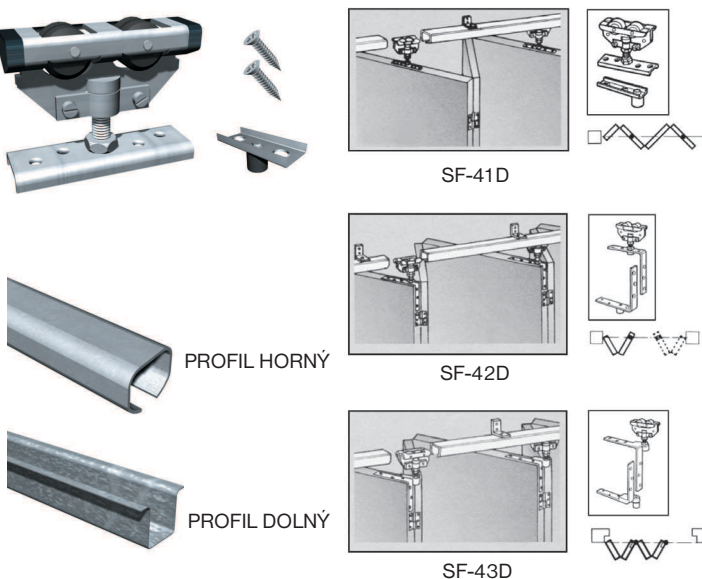

**PROFIL OCEĽOVÝ**

| Typ                      | Dĺžka | Povrchová úprava | Obj. číslo |
|--------------------------|-------|------------------|------------|
| SF-41D/42D/<br>43D dolný | 3 m   | Zinok            | 99-004130  |
| SF-201/401               | 5 m   | Zinok            | 99-004150  |

# KOVANIE NA POSUVNÉ DVERE

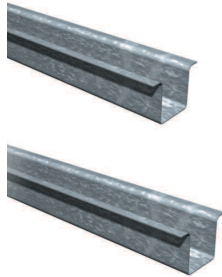
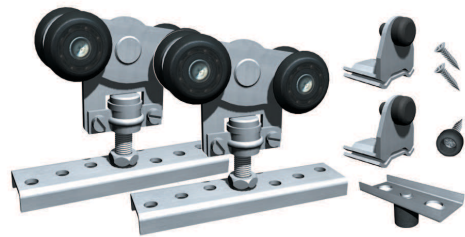
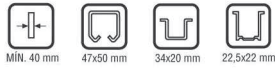

PROFIL HORNÝ

PROFIL DOLNÝ

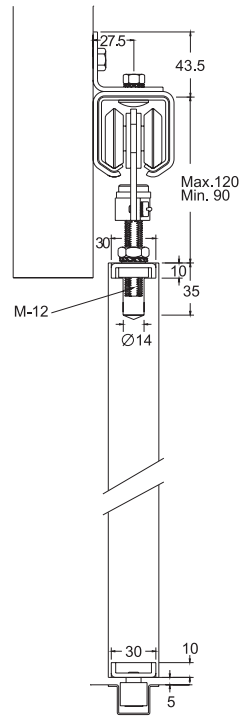

## KOVANIE SF-401

| Typ    | Nosnosť   | Hrúbka dverí | Povrchová úprava | Obj. číslo |
|--------|-----------|--------------|------------------|------------|
| SF-401 | do 300 kg | od 40 mm     | Nikel            | 99-040100  |

## PROFIL OCEĽOVÝ

| Typ          | Dĺžka | Povrchová úprava | Obj. číslo |
|--------------|-------|------------------|------------|
| SF-201 horný | 5 m   | Zinok            | 99-030050  |

## PROFIL OCEĽOVÝ

| Typ          | Dĺžka | Povrchová úprava | Obj. číslo |
|--------------|-------|------------------|------------|
| SF-401 dolný | 3 m   | Zinok            | 99-004130  |
| SF-401 dolný | 5 m   | Zinok            | 99-004150  |



## 5.4 SYSTÉM POSUVNÝCH DVERÍ NA VSTAVANÉ SKRINE

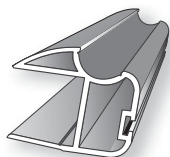

WENUS

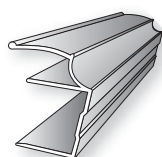

WEGA

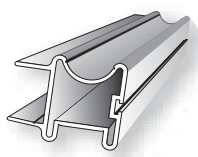

NEPTUN

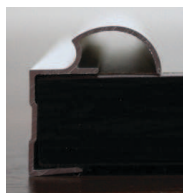

ORION



ERIS

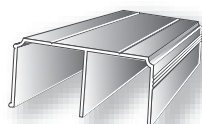

Profil horný

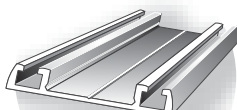

Profil dolný

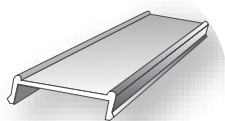

Clip

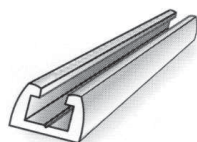

Vymedzovací pre sklo

## ÚCHYTKY 18 MM

PRIAZNIVÁ  
CENA 1

| Typ    | Dĺžka  | Povrchová úprava | Obj. číslo |
|--------|--------|------------------|------------|
| WENUS  | 2,75 m | striebro         | 99-000293  |
| WENUS  | 2,75 m | bronz            | 99-000294  |
| WEGA   | 2,75 m | striebro         | 99-000284  |
| WEGA   | 2,75 m | bronz            | 99-000282  |
| ORION  | 2,75 m | striebro         | 99-000583  |
| ORION  | 2,75 m | bronz            | 99-000582  |
| NEPTUN | 2,75 m | striebro         | 99-000250  |
| NEPTUN | 2,75 m | bronz            | 99-000248  |
| ERIS   | 2,75 m | striebro         | 99-000581  |
| ERIS   | 2,75 m | bronz            | 99-000580  |

## ŠTETINA

PRIAZNIVÁ  
CENA 1

| Typ                            | Obj. číslo |
|--------------------------------|------------|
| Štetina stredová samolepiaca   | 99-000352  |
| Štetina bočná samolepiaca      | 99-000355  |
| Štetina bočná bez lepidla      | 99-000354  |
| Štetina stredová               |            |
| Štetina bez lepidla, zasúvacia |            |

## PROFIL

PRIAZNIVÁ  
CENA 1

| Typ              | Dĺžka v m | Povrchová úprava | Obj. číslo |
|------------------|-----------|------------------|------------|
| Vodiaci 95 horný | 4,05      | striebro         | 99-000452  |
| Vodiaci 95 horný | 4,05      | bronz            | 99-000444  |
| Vodiaci 95 horný | 3         | striebro         | 99-000451  |
| Vodiaci 95 dolný | 4,05      | striebro         | 99-000392  |
| Vodiaci 95 dolný | 4,05      | bronz            | 99-000388  |
| Vodiaci 95 dolný | 3         | striebro         | 99-000391  |
| Vodiaci 75 horný | 4,05      | striebro         | 99-000435  |
| Vodiaci 75 horný | 4,04      | bronz            | 99-000425  |
| Vodiaci 75 horný | 3         | striebro         | 99-000434  |
| Vodiaci 75 horný | 3         | bronz            | 99-000424  |
| Vodiaci 75 dolný | 4,05      | striebro         | 99-000376  |
| Vodiaci 75 dolný | 4,05      | bronz            | 99-000368  |
| Vodiaci 75 dolný | 3         | striebro         | 99-000375  |
| Vodiaci 75 dolný | 3         | bronz            | 99-000376  |
| Stredný H18      | 3,05      | bronz            | 99-000193  |
| Stredný H18      | 3         | striebro         | 99-000195  |
| Stredný H17      | 3         | striebro         | 99-000204  |
| Stredný H17      | 3         | bronz            | 99-000202  |
| Clip 75          | 4,05      | striebro         | 99-000022  |



|                      |      |          |           |
|----------------------|------|----------|-----------|
| Clip 75              | 4,05 | bronz    | 99-000017 |
| Clip 75              | 3    | striebro | 99-000021 |
| Clip 75              | 3    | bronz    | 99-000016 |
| Clip 75              | 1,7  | striebro | 99-000018 |
| Vymedzovací pre sklo |      |          | 99-000565 |

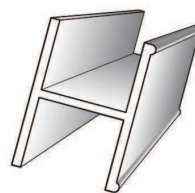

#### LIŠTY

PRIAZNIVÁ  
CENA ①

| Typ                               | Dĺžka<br>v m | Povrchová<br>úprava | Obj. číslo |
|-----------------------------------|--------------|---------------------|------------|
| Dolná 10 mm                       | 3 m          | bronz               | 99-000153  |
| Dolná 10 mm                       | 3 m          | striebro            | 99-000155  |
| Horná 75, 10 mm                   | 3 m          | bronz               | 99-000165  |
| Horná 75, 10 mm                   | 3 m          | striebro            | 99-000167  |
| Vodiaca na skladané dvere - dolná |              |                     | 99-000492  |



Lišta dolná

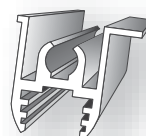

Lišta horná

#### KOVANIE

PRIAZNIVÁ  
CENA ①

| Typ          | Dĺžka | Povrchová<br>úprava | Obj. číslo |
|--------------|-------|---------------------|------------|
| SATURN horné |       |                     | 99-000514  |
| SIGNUM horné |       |                     | 99-000100  |
| MATRIX horné |       |                     | 99-000513  |
| LEXUS horné  |       |                     | 99-000512  |
| MATRIX dolné |       |                     | 99-000510  |
| LEXUS dolné  |       |                     | 99-000509  |



MATRIX horné

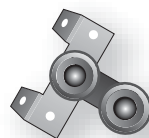

LEXUS horné

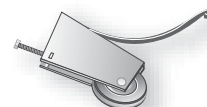

MATRIX dolné



LEXUS dolné

# Drevársky magazín

Odborný časopis na podporu drevárskej a nábytkárskej výroby

Časopis pre odborníkov, ktorí si cenia informácie



- Nositeľ odborných informácií pre vzdelávanie a prax
- Významný informačný partner najväčších profesijných združení (ZSD SR, AČN, SDP ČR) odborných škôl a inštitúcií v SR a ČR
- Mediálny partner odborných veľtrhov v SR a ČR

## www.drevmag.com

odborný denne aktualizovaný internetový portál pre profesionálov

## Drevmagletter

elektronický magazín s aktuálnymi informáciami z odboru

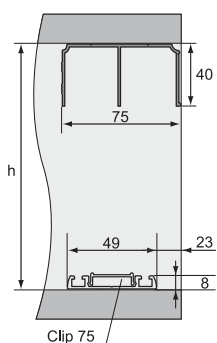

## Posuvné kovanie Eris

Maximálna nosnosť 50 kg



Rozmery otvoru pre dolné kovanie

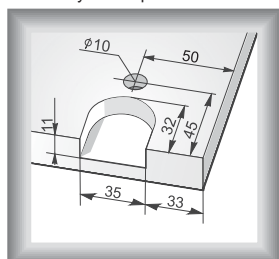

Prekrytie

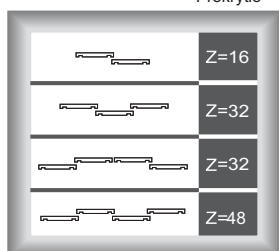

Montáž DTD do úchytky 18 mm

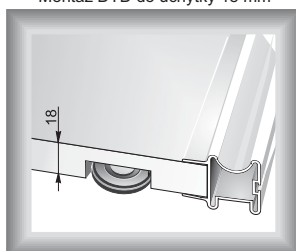

|  | Názov                | Rozmery | Povrch. úp. | Objed. číslo |
|--|----------------------|---------|-------------|--------------|
|  | Úchytka Eris 18 mm   | 275 cm  | bronz       | 99-000580    |
|  | Úchytka Eris 18 mm   | 275 cm  | striebro    | 99-000581    |
|  | Profil vodiaci horný | 300 cm  | bronz       | 99-000424    |
|  | Profil vodiaci horný | 300 cm  | striebro    | 99-000434    |
|  | Profil vodiaci horný | 405 cm  | bronz       | 99-000425    |
|  | Profil vodiaci horný | 405 cm  | striebro    | 99-000435    |
|  | Profil vodiaci dolný | 300 cm  | bronz       | 99-000367    |
|  | Profil vodiaci dolný | 300 cm  | striebro    | 99-000375    |
|  | Profil vodiaci dolný | 405 cm  | bronz       | 99-000368    |
|  | Profil vodiaci dolný | 405 cm  | striebro    | 99-000376    |
|  | Profil Clip 75       | 300 cm  | bronz       | 99-000016    |
|  | Profil Clip 75       | 300 cm  | striebro    | 99-000021    |
|  | Profil Clip 75       | 405 cm  | bronz       | 99-000017    |
|  | Profil Clip 75       | 405 cm  | striebro    | 99-000022    |
|  | Uholník L1           | 300 cm  | bronz       | 99-000111    |
|  | Uholník L1           | 300 cm  | striebro    | 99-000113    |
|  | Kovanie horné Lexus  |         |             | 99-000512    |

|  | Názov                       | Rozmery | Povrch. úp. | Objed. číslo |
|--|-----------------------------|---------|-------------|--------------|
|  | Kovanie dolné Lexus         |         |             | 99-000509    |
|  | Brzda dverí ľavá            |         |             | 99-000297    |
|  | Brzda dverí pravá           |         |             | 99-000298    |
|  | Doraz do vodiacej lišty     |         |             | 99-000301    |
|  | Štetina bočná bez lepom     |         |             | 99-000354    |
|  | Štetina bočná s lepom       |         |             | 99-000355    |
|  | Štetina stredová s lepom    |         |             | 99-000352    |
|  | Profil vymedzovací pre sklo |         |             | 99-000565    |

## Posuvné kovanie Neptun

Maximálna nosnosť 50 kg

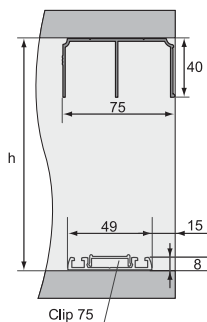

Rozmery otvoru pre dolné kovanie

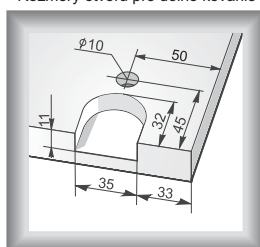

Prekrytie

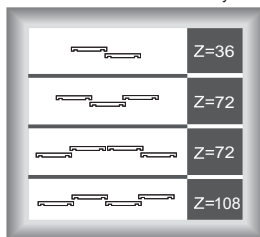

Montáž DTD do úchytky 18 mm

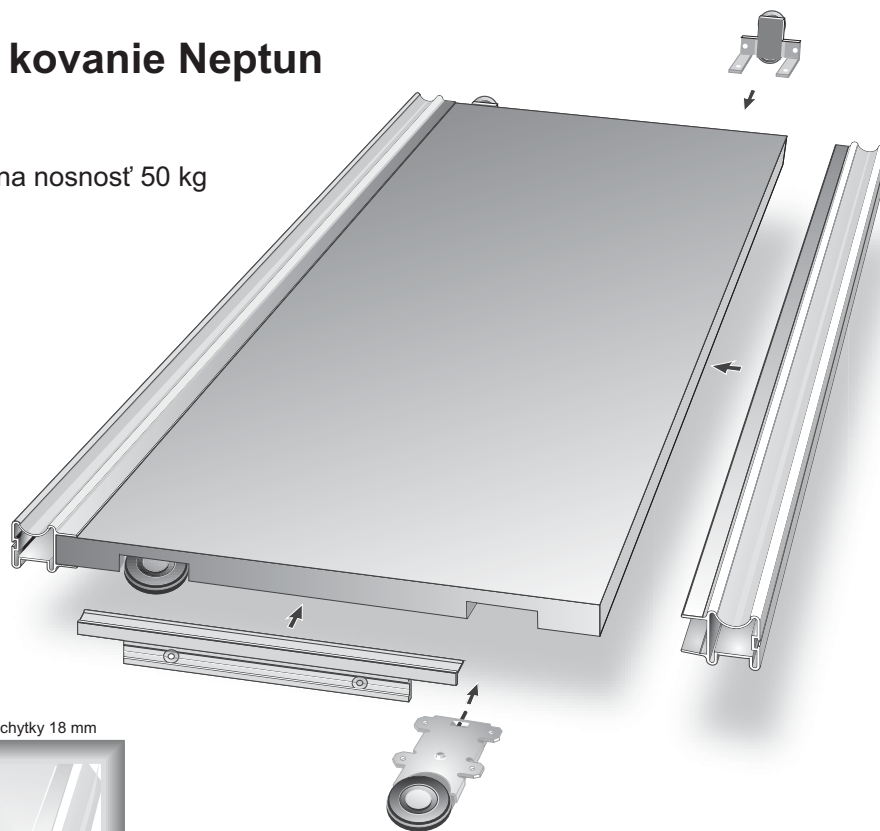
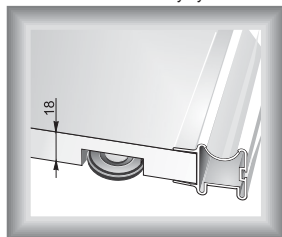

|  | Názov                | Rozmery | Povrch. úp. | Objed. číslo |
|--|----------------------|---------|-------------|--------------|
|  | Úchytka Neptun 18 mm | 275 cm  | bronz       | 99-000248    |
|  | Úchytka Neptun 18 mm | 275 cm  | striebro    | 99-000250    |
|  | Profil vodiaci horný | 300 cm  | bronz       | 99-000424    |
|  | Profil vodiaci horný | 300 cm  | striebro    | 99-000434    |
|  | Profil vodiaci horný | 405 cm  | bronz       | 99-000425    |
|  | Profil vodiaci horný | 405 cm  | striebro    | 99-000435    |
|  | Profil vodiaci dolný | 300 cm  | bronz       | 99-000367    |
|  | Profil vodiaci dolný | 300 cm  | striebro    | 99-000375    |
|  | Profil vodiaci dolný | 405 cm  | bronz       | 99-000368    |
|  | Profil vodiaci dolný | 405 cm  | striebro    | 99-000376    |
|  | Profil Clip 75       | 300 cm  | bronz       | 99-000016    |
|  | Profil Clip 75       | 300 cm  | striebro    | 99-000021    |
|  | Profil Clip 75       | 405 cm  | bronz       | 99-000017    |
|  | Profil Clip 75       | 405 cm  | striebro    | 99-000022    |
|  | Uholník L1           | 300 cm  | bronz       | 99-000111    |
|  | Uholník L1           | 300 cm  | striebro    | 99-000113    |
|  | Kovanie horné Lexus  |         |             | 99-000512    |

|  | Názov                       | Rozmery | Povrch. úp. | Objed. číslo |
|--|-----------------------------|---------|-------------|--------------|
|  | Kovanie dolné Lexus         |         |             | 99-000509    |
|  | Brzda dverí ľavá            |         |             | 99-000297    |
|  | Brzda dverí pravá           |         |             | 99-000298    |
|  | Doraz do vodiacej lišty     |         |             | 99-000301    |
|  | Štetina bočná bez lepu      |         |             | 99-000354    |
|  | Štetina bočná s lepom       |         |             | 99-000355    |
|  | Štetina stredová s lepom    |         |             | 99-000352    |
|  | Profil vymedzovací pre sklo |         |             | 99-000565    |

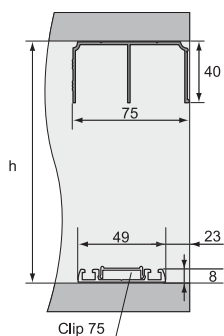

## Posuvné kovanie Orion

Maximálna nosnosť 50 kg



Rozmery otvoru pre dolné kovanie

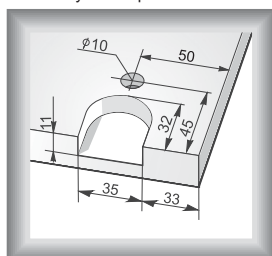

Prekrytie

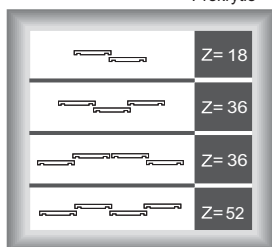

Montáž DTD do úchytky 18 mm

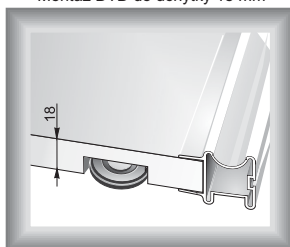

|  | Názov                | Rozmery | Povrch. úp. | Objed. číslo |
|--|----------------------|---------|-------------|--------------|
|  | Úchytka Orion 18 mm  | 275 cm  | bronz       | 99-000582    |
|  | Úchytka Orion 18 mm  | 275 cm  | striebro    | 99-000583    |
|  | Profil vodiaci horný | 300 cm  | bronz       | 99-000424    |
|  | Profil vodiaci horný | 300 cm  | striebro    | 99-000434    |
|  | Profil vodiaci horný | 405 cm  | bronz       | 99-000425    |
|  | Profil vodiaci horný | 405 cm  | striebro    | 99-000435    |
|  | Profil vodiaci dolný | 300 cm  | bronz       | 99-000367    |
|  | Profil vodiaci dolný | 300 cm  | striebro    | 99-000375    |
|  | Profil vodiaci dolný | 405 cm  | bronz       | 99-000368    |
|  | Profil vodiaci dolný | 405 cm  | striebro    | 99-000376    |
|  | Profil Clip 75       | 300 cm  | bronz       | 99-000016    |
|  | Profil Clip 75       | 300 cm  | striebro    | 99-000021    |
|  | Profil Clip 75       | 405 cm  | bronz       | 99-000017    |
|  | Profil Clip 75       | 405 cm  | striebro    | 99-000022    |
|  | Uholník L1           | 300 cm  | bronz       | 99-000111    |
|  | Uholník L1           | 300 cm  | striebro    | 99-000113    |
|  | Kovanie horné Lexus  |         |             | 99-000512    |

|  | Názov                       | Rozmery | Povrch. úp. | Objed. číslo |
|--|-----------------------------|---------|-------------|--------------|
|  | Kovanie dolné Lexus         |         |             | 99-000509    |
|  | Brzda dverí ľavá            |         |             | 99-000297    |
|  | Brzda dverí pravá           |         |             | 99-000298    |
|  | Doraz do vodiacej lišty     |         |             | 99-000301    |
|  | Štetina bočná bez lepu      |         |             | 99-000354    |
|  | Štetina bočná s lepom       |         |             | 99-000355    |
|  | Štetina stredová s lepom    |         |             | 99-000352    |
|  | Profil vymedzovací pre sklo |         |             | 99-000565    |

Montáž úchytky

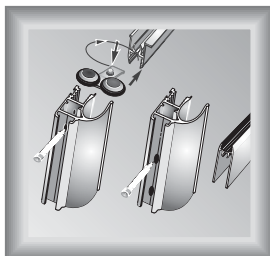

Prekrytie

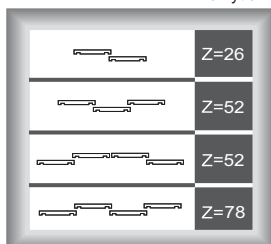

Montáž DTD do úchytky 10 mm

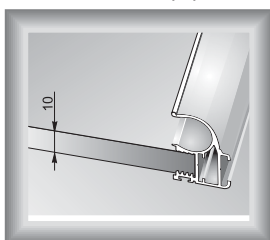

## Posuvné kovanie Saturn

Maximálna nosnosť 40 kg

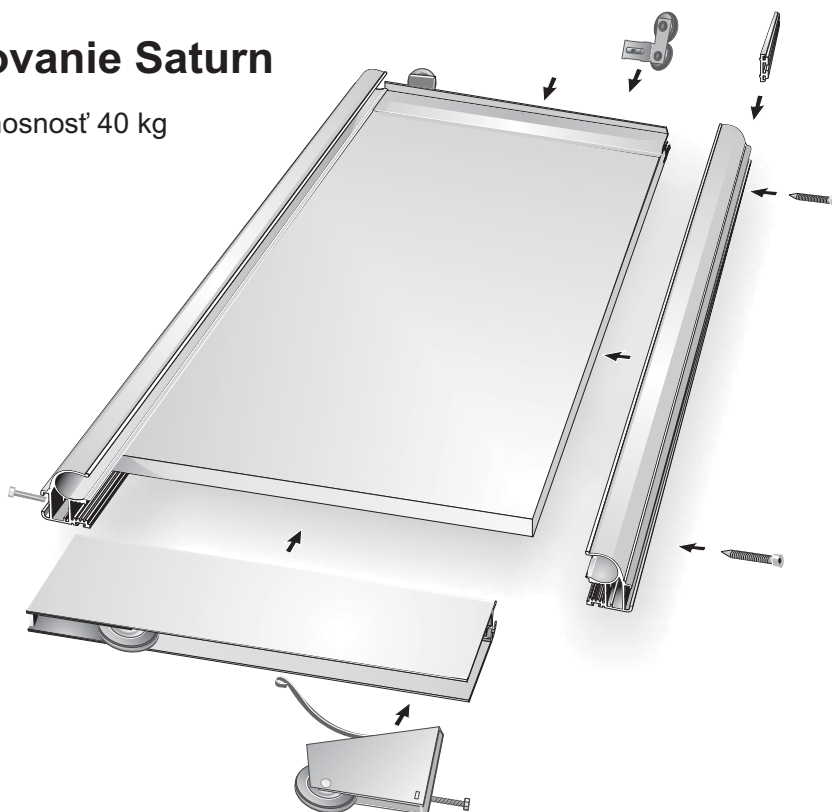
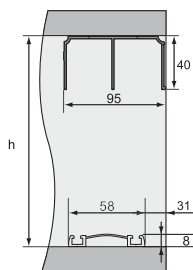

|  | Názov                   | Rozmery | Povrch. úp. | Objed. číslo |
|--|-------------------------|---------|-------------|--------------|
|  | Úchytka Saturn 10 mm    | 275 cm  | bronz       | 99-000266    |
|  | Úchytka Saturn 10 mm    | 275 cm  | striebro    | 99-000269    |
|  | Profil vodiaci horný 95 | 300 cm  | bronz       | 99-000443    |
|  | Profil vodiaci horný 95 | 300 cm  | striebro    | 99-000451    |
|  | Profil vodiaci dolný 95 | 300 cm  | bronz       | 99-000387    |
|  | Profil vodiaci dolný 95 | 300 cm  | striebro    | 99-000391    |
|  | Lišta horná 75/10 mm    | 300 cm  | bronz       | 99-000165    |
|  | Lišta horná 75/10 mm    | 300 cm  | striebro    | 99-000167    |
|  | Lišta dolná 10 mm       | 300 cm  | bronz       | 99-000153    |
|  | Lišta dolná 10 mm       | 300 cm  | striebro    | 99-000155    |
|  | Kovanie dolné Matrix    |         |             | 99-000510    |
|  | Kovanie horné Saturn    |         |             | 99-000514    |

|  | Názov                       | Rozmery   | Povrch. úp. | Objed. číslo |
|--|-----------------------------|-----------|-------------|--------------|
|  | Profil stredný H18          | 300 cm    | bronz       | 99-000193    |
|  | Profil stredný H18          | 300 cm    | striebro    | 99-000195    |
|  | Brzda dverí ľavá            |           |             | 99-000297    |
|  | Brzda dverí pravá           |           |             | 99-000298    |
|  | Doraz do vodiacej lišty     |           |             | 99-000301    |
|  | Štetina bočná bez lepu      |           |             | 99-000354    |
|  | Štetina bočná s lepom       |           |             | 99-000355    |
|  | Štetina stredová s lepom    |           |             | 99-000352    |
|  | Profil vymedzovací pre sklo |           |             | 99-000565    |
|  | Krytka 10 mm                | 270 cm    | bronz       | 99-000169    |
|  | Krytka 10 mm                | 270 cm    | striebro    | 99-000171    |
|  | Skrutka                     | 6,3x32 mm |             | 99-000006    |

Montáž úchytky



Prekrytie

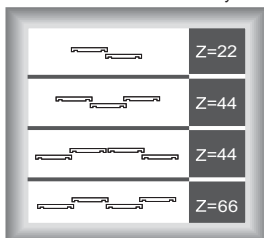

Montáž DTD do úchytky 10 mm

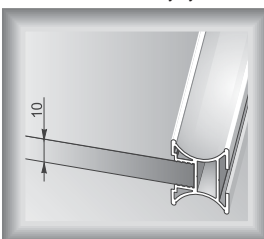

## Posuvné kovanie Uran

Maximálna nosnosť 40 kg

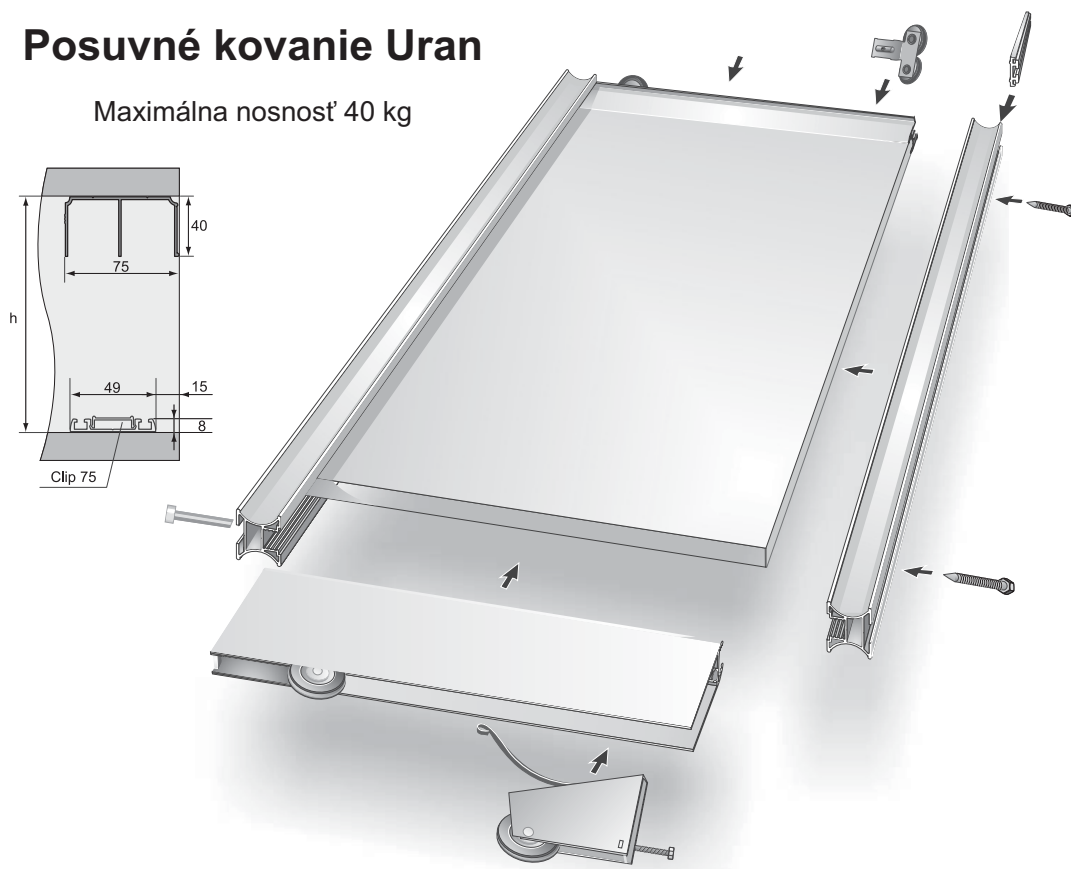

|  | Názov                | Rozmery | Povrch. úp. | Objed. číslo |
|--|----------------------|---------|-------------|--------------|
|  | Úchytka Uran 10 mm   | 275 cm  | striebro    | 99-000276    |
|  | Profil vodiaci horný | 300 cm  | bronz       | 99-000424    |
|  | Profil vodiaci horný | 300 cm  | striebro    | 99-000434    |
|  | Profil vodiaci horný | 405 cm  | bronz       | 99-000425    |
|  | Profil vodiaci horný | 405 cm  | striebro    | 99-000435    |
|  | Profil vodiaci dolný | 300 cm  | bronz       | 99-000367    |
|  | Profil vodiaci dolný | 300 cm  | striebro    | 99-000375    |
|  | Profil vodiaci dolný | 405 cm  | bronz       | 99-000368    |
|  | Profil vodiaci dolný | 405 cm  | striebro    | 99-000376    |
|  | Profil Clip 75       | 300 cm  | bronz       | 99-000016    |
|  | Profil Clip 75       | 300 cm  | striebro    | 99-000021    |
|  | Profil Clip 75       | 405 cm  | bronz       | 99-000017    |
|  | Profil Clip 75       | 405 cm  | striebro    | 99-000022    |
|  | Lišta horná 75/10 mm | 300 cm  | bronz       | 99-000165    |
|  | Lišta horná 75/10 mm | 300 cm  | striebro    | 99-000167    |
|  | Lišta dolná 10 mm    | 300 cm  | bronz       | 99-000153    |
|  | Lišta dolná 10 mm    | 300 cm  | striebro    | 99-000155    |
|  | Kovanie dolné Matrix |         |             | 99-000510    |
|  | Kovanie horné Matrix |         |             | 99-000513    |

|  | Názov                       | Rozmery   | Povrch. úp. | Objed. číslo |
|--|-----------------------------|-----------|-------------|--------------|
|  | Profil stredný H18          | 300 cm    | bronz       | 99-000193    |
|  | Profil stredný H18          | 300 cm    | striebro    | 99-000195    |
|  | Brzda dverí ľavá            |           |             | 99-000297    |
|  | Brzda dverí pravá           |           |             | 99-000298    |
|  | Doraz do vodiacej lišty     |           |             | 99-000301    |
|  | Štetina bočná bez lepu      |           |             | 99-000354    |
|  | Štetina bočná s lepom       |           |             | 99-000355    |
|  | Štetina stredová s lepom    |           |             | 99-000352    |
|  | Profil vymedzovací pre sklo |           |             | 99-000565    |
|  | Krytka 10 mm                | 270 cm    | bronz       | 99-000169    |
|  | Krytka 10 mm                | 270 cm    | striebro    | 99-000171    |
|  | Skrutka                     | 6,3x32 mm |             | 99-000006    |

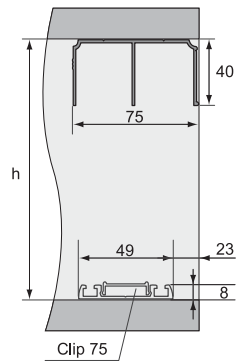

Clip 75

Rozmery otvoru pre dolné kovanie

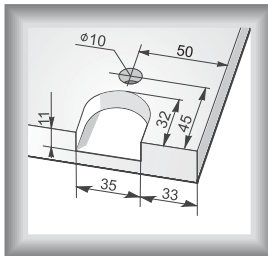

Prekrytie

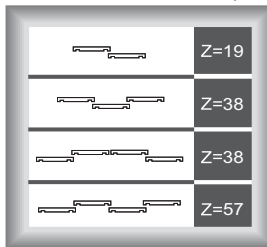

Montáž DTD do úchytky 18 mm

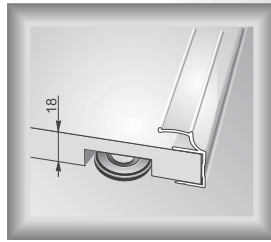

## Posuvné kovanie Vega

Maximálna nosnosť 50 kg



|  | Názov                | Rozmery | Povrch. úp. | Objed. číslo |
|--|----------------------|---------|-------------|--------------|
|  | Úchytka Vega 18 mm   | 275 cm  | bronz       | 99-000282    |
|  | Úchytka Vega 18 mm   | 275 cm  | striebro    | 99-000284    |
|  | Profil vodiaci horný | 300 cm  | bronz       | 99-000424    |
|  | Profil vodiaci horný | 300 cm  | striebro    | 99-000434    |
|  | Profil vodiaci horný | 405 cm  | bronz       | 99-000425    |
|  | Profil vodiaci horný | 405 cm  | striebro    | 99-000435    |
|  | Profil vodiaci dolný | 300 cm  | bronz       | 99-000367    |
|  | Profil vodiaci dolný | 300 cm  | striebro    | 99-000375    |
|  | Profil vodiaci dolný | 405 cm  | bronz       | 99-000368    |
|  | Profil vodiaci dolný | 405 cm  | striebro    | 99-000376    |
|  | Profil Clip 75       | 300 cm  | bronz       | 99-000016    |
|  | Profil Clip 75       | 300 cm  | striebro    | 99-000021    |
|  | Profil Clip 75       | 405 cm  | bronz       | 99-000017    |
|  | Profil Clip 75       | 405 cm  | striebro    | 99-000022    |
|  | Uholník L1           | 300 cm  | bronz       | 99-000111    |
|  | Uholník L1           | 300 cm  | striebro    | 99-000113    |
|  | Kovanie horné Lexus  |         |             | 99-000512    |

|  | Názov                       | Rozmery | Povrch. úp. | Objed. číslo |
|--|-----------------------------|---------|-------------|--------------|
|  | Kovanie dolné Lexus         |         |             | 99-000509    |
|  | Brzda dverí ľavá            |         |             | 99-000297    |
|  | Brzda dverí pravá           |         |             | 99-000298    |
|  | Doraz do vodiacej lišty     |         |             | 99-000301    |
|  | Štetina bočná bez lepu      |         |             | 99-000354    |
|  | Štetina bočná s lepom       |         |             | 99-000355    |
|  | Štetina stredová s lepom    |         |             | 99-000352    |
|  | Profil vymedzovací pre sklo |         |             | 99-000565    |



## Posuvné kovanie Venus

Maximálna nosnosť 50 kg

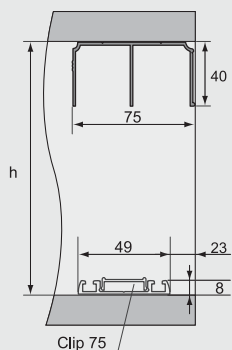

Rozmery otvoru pre dolné kovanie

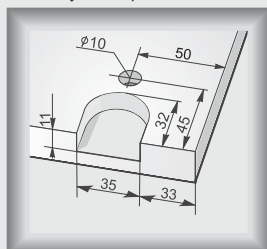

Prekrytie

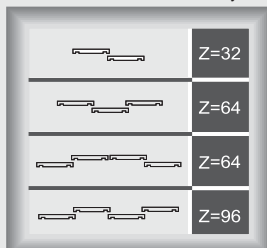

Montáž DTD do úchytky 18 mm

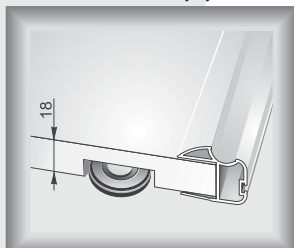

|  | Názov                | Rozmery | Povrch. úp. | Objed. číslo |
|--|----------------------|---------|-------------|--------------|
|  | Úchytka Venus 18 mm  | 275 cm  | bronz       | 99-000294    |
|  | Úchytka Venus 18 mm  | 275 cm  | striebro    | 99-000293    |
|  | Profil vodiaci horný | 300 cm  | bronz       | 99-000424    |
|  | Profil vodiaci horný | 300 cm  | striebro    | 99-000434    |
|  | Profil vodiaci horný | 405 cm  | bronz       | 99-000425    |
|  | Profil vodiaci horný | 405 cm  | striebro    | 99-000435    |
|  | Profil vodiaci dolný | 300 cm  | bronz       | 99-000367    |
|  | Profil vodiaci dolný | 300 cm  | striebro    | 99-000375    |
|  | Profil vodiaci dolný | 405 cm  | bronz       | 99-000368    |
|  | Profil vodiaci dolný | 405 cm  | striebro    | 99-000376    |
|  | Profil Clip 75       | 300 cm  | bronz       | 99-000016    |
|  | Profil Clip 75       | 300 cm  | striebro    | 99-000021    |
|  | Profil Clip 75       | 405 cm  | bronz       | 99-000017    |
|  | Profil Clip 75       | 405 cm  | striebro    | 99-000022    |
|  | Uholník L1           | 300 cm  | bronz       | 99-000111    |
|  | Uholník L1           | 300 cm  | striebro    | 99-000113    |
|  | Kovanie horné Lexus  |         |             | 99-000512    |

|  | Názov                       | Rozmery | Povrch. úp. | Objed. číslo |
|--|-----------------------------|---------|-------------|--------------|
|  | Kovanie dolné Lexus         |         |             | 99-000509    |
|  | Brzda dverí ľavá            |         |             | 99-000297    |
|  | Brzda dverí pravá           |         |             | 99-000298    |
|  | Doraz do vodiacej lišty     |         |             | 99-000301    |
|  | Štetina bočná bez lepu      |         |             | 99-000354    |
|  | Štetina bočná s lepom       |         |             | 99-000355    |
|  | Štetina stredová s lepom    |         |             | 99-000352    |
|  | Profil vymedzovací pre sklo |         |             | 99-000565    |

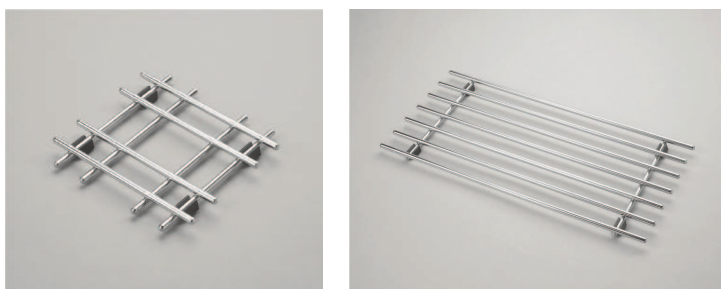
**6.1 KUCHYNSKÉ DOPLNKY**

**ODKVAPÁVAČ NA TANIERE**

| Povrchová úprava | Rozmery       | Obj. číslo  |
|------------------|---------------|-------------|
| chróm            | 305x200x85 mm | 20-10080320 |

**PODLOŽKA POD PLECH**

| Povrchová úprava | Rozmery       | Obj. číslo  |
|------------------|---------------|-------------|
| chróm            | 502x242x20 mm | 20-10080220 |

**PODLOŽKA POD HRNIEC**

| Povrchová úprava | Rozmery       | Obj. číslo  |
|------------------|---------------|-------------|
| chróm            | 200x200x20 mm | 20-10080260 |

**DRŽIAK POHÁROV JEDNORADOVÝ**

| Povrchová úprava | Rozmery       | Obj. číslo  |
|------------------|---------------|-------------|
| chróm            | 110x340x66 mm | 20-10080060 |

**DRŽIAK POHÁROV DVOJRADOVÝ**

| Povrchová úprava | Rozmery       | Obj. číslo  |
|------------------|---------------|-------------|
| chróm            | 210x340x66 mm | 20-10080070 |

**DRŽIAK POHÁROV ŠTVORRADOVÝ**

| Povrchová úprava | Rozmery       | Obj. číslo  |
|------------------|---------------|-------------|
| chróm            | 407x340x66 mm | 20-10080080 |

**ODKVAPKÁVAČ**

| Povrchová úprava | Rozmery        | Obj. číslo  |
|------------------|----------------|-------------|
| chróm            | 350x320x110 mm | 20-10080130 |

**STOJAN NA PAPIEROVÉ UTIERKY**

| Povrchová úprava | Rozmery     | Obj. číslo  |
|------------------|-------------|-------------|
| chróm            | Ø160x278 mm | 20-08033001 |

PRIAZNIVÁ  
CENA 1

#### DVOJKŔŠ PLNOVÝSUVNÝ BOČNÝ S DORAZOM

| Šírka skrinky | Rozmery        | Obj. číslo  |
|---------------|----------------|-------------|
| 150 mm        | 115x445x485 mm | 20-10020010 |
| 200 mm        | 160x460x480 mm | 20-10029320 |

TOP  
KVALITA

#### RÁM

| Výška korpusu | Typ   | Povrchová úprava | Obj. číslo  |
|---------------|-------|------------------|-------------|
| 599 mm        | Ľavý  | Hliník           | 71-54559266 |
| 599 mm        | Pravý | Hliník           | 71-54559276 |

TOP  
KVALITA

#### KOŠE

| Šírka  | Povrchová úprava | Obj. číslo  |
|--------|------------------|-------------|
| 110 mm | Chróm            | 71-54560208 |
| 160 mm | Chróm            | 71-54560217 |
| 210 mm | Chróm            | 71-54560244 |
| 320 mm | Chróm            | 71-54560253 |

PRIAZNIVÁ  
CENA 1

#### KARUSEL 180°

| Šírka skrinky | Rozmery        | Obj. číslo  |
|---------------|----------------|-------------|
| min. 800 mm   | 750x400x140 mm | 20-10021190 |
| min. 900 mm   | 850x450x140 mm | 20-10021200 |

TOP  
KVALITA

#### KARUSEL 180°

| Šírka skrinky | Rozmery                | Obj. číslo  |
|---------------|------------------------|-------------|
| min. 900 mm   | 750 x 420 x 495-652 mm | 71-54252202 |
| min. 1000 mm  | 850 x 476 x 495-652 mm | 71-54252203 |

PRIAZNIVÁ  
CENA 1

#### KARUSEL 270°

| Šírka skrinky | Rozmery    | Obj. číslo  |
|---------------|------------|-------------|
| min. 800 mm   | 620-820 mm | 20-10029010 |
| min. 900 mm   | 620-820 mm | 20-10021180 |

TOP  
KVALITA

#### KARUSEL 270°

| Šírka skrinky | Rozmery          | Obj. číslo  |
|---------------|------------------|-------------|
| min. 800 mm   | 700 x 590-840 mm | 71-54253202 |
| min. 900 mm   | 820 x 590-840 mm | 71-54253203 |

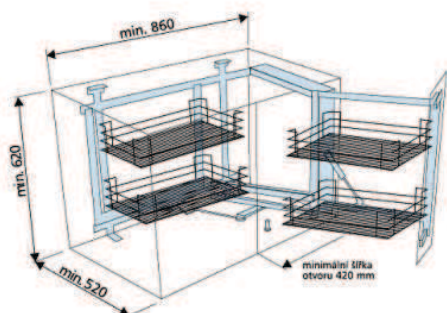
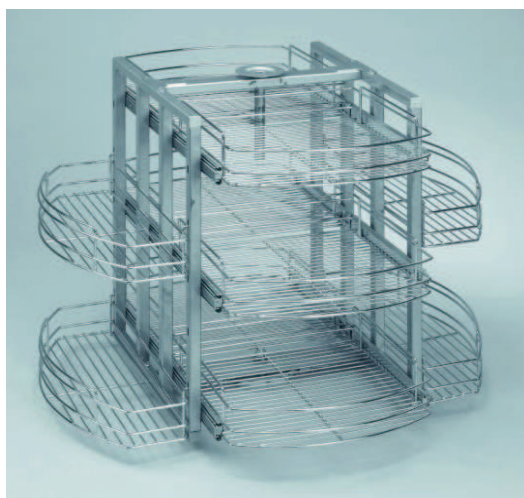

DRŔTENÝ PROGRAM

**6.2 VÝSUVNÉ OTOČNÉ ROHY**

**PRIAZNIVÁ  
CENA** ①

**KARUSEL MULTIFUNKČNÝ 360°**

| Šírka skrinky | Výška      | Obj. číslo  |
|---------------|------------|-------------|
| min. 800 mm   | 650-760 mm | 20-02070001 |

**TOP  
KVALITA**
**RÁM**

| Výška korpusu | Typ   | Povrchová úprava | Obj. číslo  |
|---------------|-------|------------------|-------------|
| 570-770 mm    | Ľavý  | RAL 9006         | 71-54617230 |
| 570-770 mm    | Pravý | RAL 9006         | 71-54617220 |

**TOP  
KVALITA**
**KOŠE**

| Povrchová úprava | Obj. číslo  |
|------------------|-------------|
| Chróm            | 71-54617266 |
| RAL9006          | 71-54617966 |

**ROH VÝSUVNO - OTOČNÝ**

| Typ   | Rozmery     | Obj. číslo  |
|-------|-------------|-------------|
| ľavý  | 360x450x520 | 20-10029410 |
| pravý | 360x450x520 | 20-10029420 |
| ľavý  | 360x520x520 | 20-00051201 |
| pravý | 360x520x520 | 20-00051202 |

**TOP  
KVALITA**
**ROH VÝSUVNO-OTOČNÝ**

| Šírka dverí | Typ   | Obj. číslo  |
|-------------|-------|-------------|
| 450 mm      | Ľavý  | 71-54133245 |
| 450 mm      | Pravý | 71-54133246 |
| 500 mm      | Ľavý  | 71-54133250 |
| 500 mm      | Pravý | 71-54133251 |
| 600 mm      | Ľavý  | 71-54133260 |
| 600 mm      | Pravý | 71-54133261 |

**TYČ**

| Výška      | Povrchová úprava | Obj. číslo  |
|------------|------------------|-------------|
| 720-900 mm | Chróm            | 71-54133201 |

## 6.3 ZÁVESNÝ RELING

### OBLÚK 90°

| Povrchová úprava | Obj. číslo  |
|------------------|-------------|
| chróm            | 20-05056001 |



### VSUVKA

| Povrchová úprava | Obj. číslo  |
|------------------|-------------|
| Biela - plast    | 20-05001601 |



### ÚCHYTKA MADLA

| Povrchová úprava | výška | Obj. číslo  |
|------------------|-------|-------------|
| chróm            | 47 mm | 20-05053001 |
| chróm            | 70 mm | 20-10050540 |
| chróm            |       | 20-05025001 |



### MADLO

| Povrchová úprava | výška       | Obj. číslo  |
|------------------|-------------|-------------|
| chróm            | Ø16x450 mm  | 20-10050490 |
| chróm            | Ø16x600 mm  | 20-10050500 |
| chróm            | Ø16x900 mm  | 20-10050510 |
| chróm            | Ø16x1200 mm | 20-10050520 |



### KONCOVKA MADLA

| Povrchová úprava | Obj. číslo  |
|------------------|-------------|
| chróm            | 20-10050580 |
| chróm            | 20-10050460 |



### KONCOVKA MADLA

| Povrchová úprava | Obj. číslo  |
|------------------|-------------|
| chróm            | 20-05062001 |



### ROHOVÁ POLICA

| Typ           | Povrch. úprava | Rozmery v mm | Obj. číslo  |
|---------------|----------------|--------------|-------------|
| Jednostupňová | chróm          | 275x275x243  | 20-05008001 |
| Dvojestupňová | chróm          | 317x317x425  | 20-05007001 |



**DRŽIAK ROLIEK**

| Typ           | Povrch. úprava | Rozmery v mm | Obj. číslo  |
|---------------|----------------|--------------|-------------|
| Jednostupňová | chróm          | 300x140x200  | 20-05045001 |
| Trojstupňová  | chróm          | 320x180x370  | 20-05044001 |

**DRŽIAK ROLIEK**

| Typ           | Povrch. úprava | Rozmery v mm | Obj. číslo  |
|---------------|----------------|--------------|-------------|
| Jednostupňová | chróm          | 355x100x200  | 20-05065001 |
| Dvojstupňová  | chróm          | 350x80x280   | 20-05011001 |

**DRŽIAK DOPLNKOV**

| Povrchová úprava | Rozmery    | Obj. číslo  |
|------------------|------------|-------------|
| chróm            | Ø90x265 mm | 20-05073001 |

**ODKVAPKAVAČ KOMBINOVANÝ**

| Materiál | Rozmery     | Obj. číslo  |
|----------|-------------|-------------|
| ocel     | 578x233x280 | 20-05073001 |

7.1 ZÁMKY NÁBYTKOVÉ

ZÁMOK NÁBYTKOVÝ

PRIAZNIVÁ  
CENA 1

| Verzia    | Povrchová úprava | Obj. číslo  |
|-----------|------------------|-------------|
| Pravý     | Poniklovaná      | 71-23226600 |
| Ľavý      | Poniklovaná      | 71-23226610 |
| Zásuvkový | Poniklovaná      | 71-23226620 |

VLOŽKA MIX

| Povrchová úprava | Obj. číslo  |
|------------------|-------------|
| Poniklovaná      | 71-21040600 |

ZÁMOK NÁBYTKOVÝ

TOP  
KVALITA

| Verzia    | Povrchová úprava | Obj. číslo  |
|-----------|------------------|-------------|
| Zásuvkový | Nikel matný      | 71-23227620 |
| Zásuvkový | Mosadz lesklá    | 71-23227520 |

Súčasť balenia: krúžok 1 ks, kľúč 2 ks

ZÁMOK NÁBYTKOVÝ

PRIAZNIVÁ  
CENA 1

| Povrchová úprava | Obj. číslo  |
|------------------|-------------|
| Poniklovaná      | 71-23240720 |
| Chróm            | 24-09101130 |

Súčasť balenia: krúžok 1 ks, kľúč 2 ks

PROTIPLECH

| Povrchová úprava | Obj. číslo  |
|------------------|-------------|
| Poniklovaná      | 71-23237991 |

ZÁMOK SKRIŇOVÝ TROJCESTNÝ

PRIAZNIVÁ  
CENA 1

| Povrchová úprava | Obj. číslo |
|------------------|------------|
| Poniklovaná      | 62-4030    |

Súčasť balenia: krúžok 1 ks, uzatvárací hák 2 ks, vodidlo tyče 4 ks, kľúč 2 ks

TYČ ZÁMKU

| Dĺžka | Povrchová úprava | Obj. číslo |
|-------|------------------|------------|
| 1 m   | Poniklovaná      | 62-1902    |
| 1,5 m | Poniklovaná      | 62-1903    |

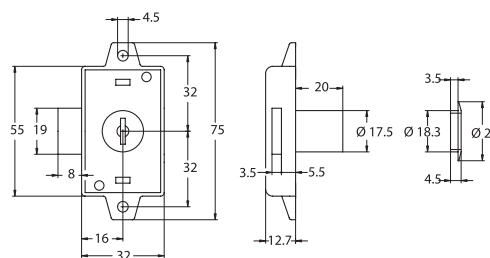
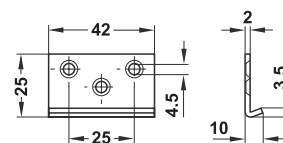
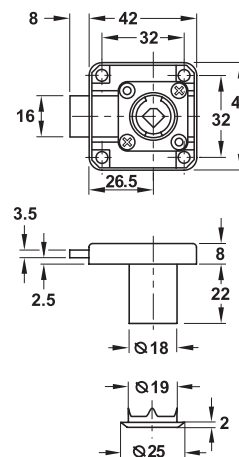
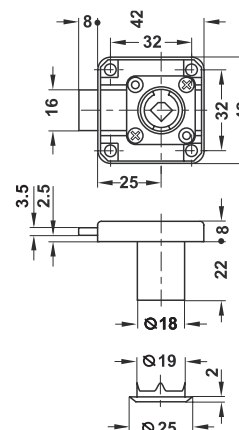
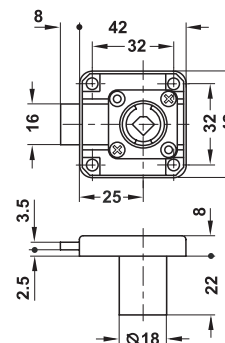
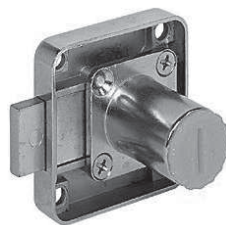

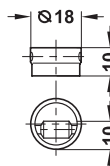
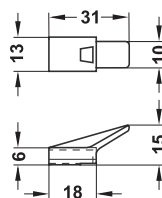
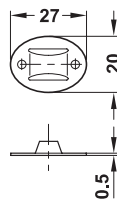
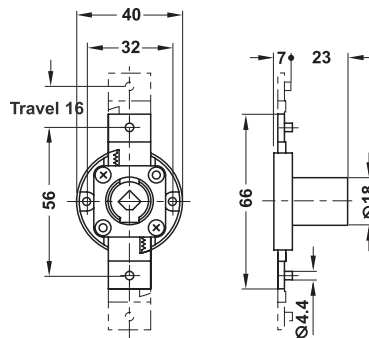
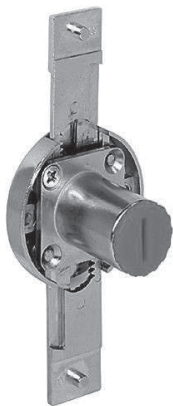
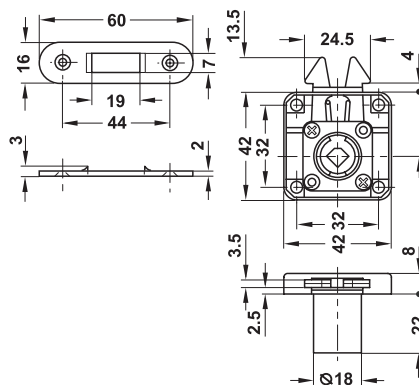
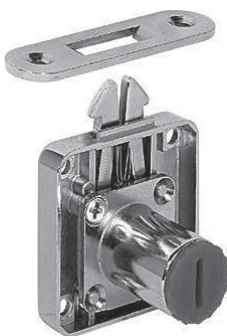
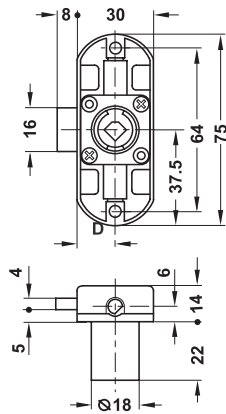
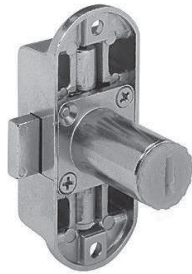

#### ZÁMOK SKRIŇOVÝ TROJCESTNÝ

| Povrchová úprava | Obj. číslo  |
|------------------|-------------|
| Poniklovaná      | 71-22464650 |

#### TYČ ZÁMKU

| Dĺžka | Povrchová úprava | Obj. číslo  |
|-------|------------------|-------------|
| 2 m   | Poniklovaná      | 71-22607209 |

#### VLOŽKA MIX

| Povrchová úprava | Obj. číslo  |
|------------------|-------------|
| Poniklovaná      | 71-21040600 |



#### ZÁMOK ROLETKOVÝ

| Povrchová úprava | Obj. číslo  |
|------------------|-------------|
| Poniklovaná      | 71-23230620 |

Súčasť balenia: protiplech 1 ks

#### VLOŽKA MIX

| Povrchová úprava | Obj. číslo  |
|------------------|-------------|
| Poniklovaná      | 71-21040600 |



#### ZÁMOK ROZVOROVÝ

| Povrchová úprava | Obj. číslo  |
|------------------|-------------|
| Poniklovaná      | 71-23776620 |

#### TYČ ZÁMKU

| Dĺžka | Povrchová úprava | Obj. číslo  |
|-------|------------------|-------------|
| 2 m   | Poniklovaná      | 71-23981930 |

#### VODIDLO TYČE

| Povrchová úprava | Obj. číslo  |
|------------------|-------------|
| Poniklovaná      | 71-23968014 |

#### KONCOVKA TYČE

| Povrchová úprava | Obj. číslo  |
|------------------|-------------|
| Plast čierny     | 71-23774920 |

#### PROTIKUS

| Povrchová úprava | Obj. číslo  |
|------------------|-------------|
| Plast hnedý      | 71-23960152 |

#### VLOŽKA MIX

| Povrchová úprava | Obj. číslo  |
|------------------|-------------|
| Poniklovaná      | 71-21040600 |



**ZÁMOK NA SKLENENÉ DVIERKA**

PRIAZNIVÁ  
CENA 1

| Hrúbka skla | Verzia | Povrchová úprava | Obj. číslo  |
|-------------|--------|------------------|-------------|
| 4 - 10 mm   | Ľavý   | Nikel matný      | 71-23342700 |
| 4 - 10 mm   | Pravý  | Nikel matný      | 71-23342710 |
| 4 - 10 mm   | Ľavý   | Nikel lesklý     | 71-23342600 |
| 4 - 10 mm   | Pravý  | Nikel lesklý     | 71-23342610 |
| 4 - 10 mm   | Ľavý   | Mosadz lesklá    | 71-23342500 |
| 4 - 10 mm   | Pravý  | Mosadz lesklá    | 71-23342510 |

Súčasť balenia: protiplech 1 ks

**VLOŽKA MIX**

| Povrchová úprava | Obj. číslo  |
|------------------|-------------|
| Poniklovaná      | 71-21040600 |

**PROTIKUS**

| Povrchová úprava | Obj. číslo  |
|------------------|-------------|
| Nikel matný      | 71-23340610 |
| Nikel lesklý     | 71-23340712 |
| Mosadz lesklá    | 71-23340810 |

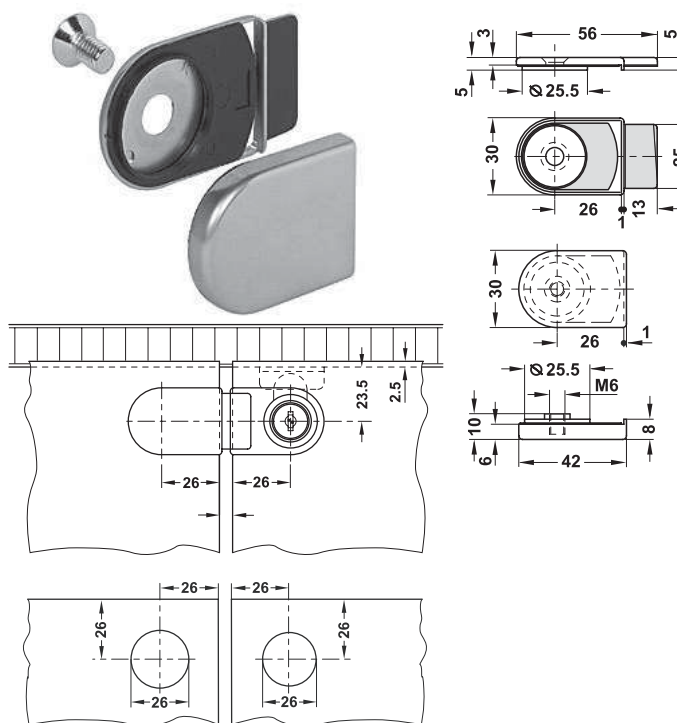
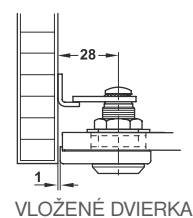
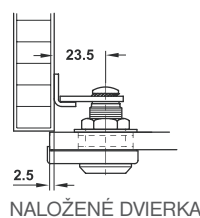
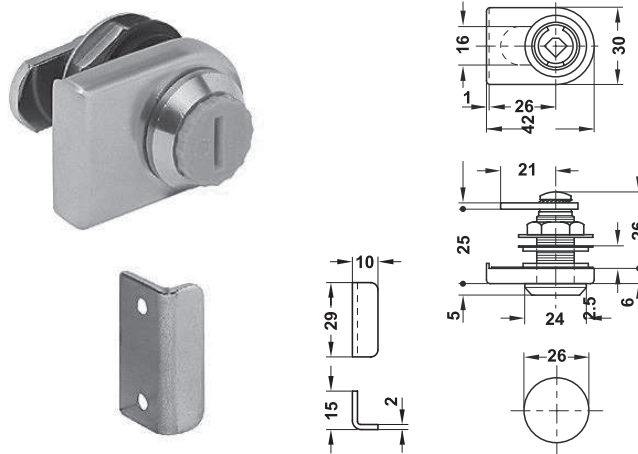

**ZÁMOK NA POSUVNÉ SKLO**

TOP  
KVALITA

| Hrúbka skla | Povrchová úprava | Obj. číslo  |
|-------------|------------------|-------------|
| 4 - 7 mm    | Poniklovaná      | 71-23344200 |

**VLOŽKA MIX**

| Povrchová úprava | Obj. číslo  |
|------------------|-------------|
| Poniklovaná      | 71-21040600 |

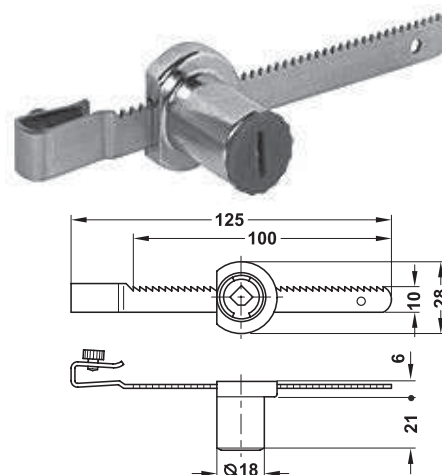

# ZÁMKY

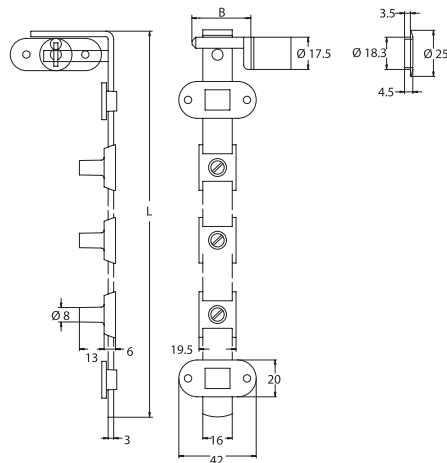
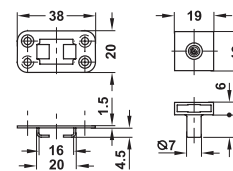
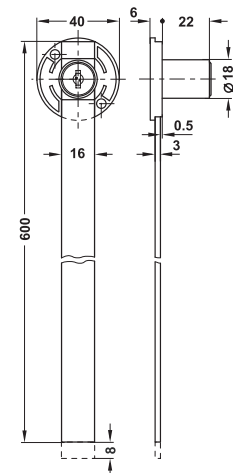
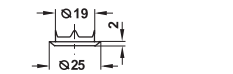
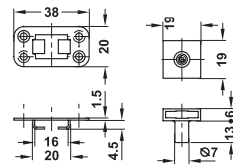
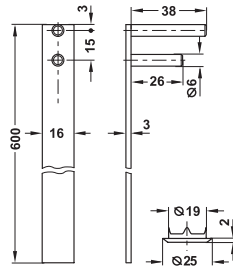
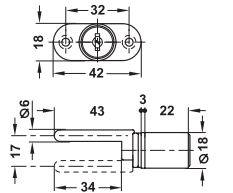
**TOP  
KVALITA**
**ZÁMOK CENTRÁLNY ČELNÝ**

| Dĺžka  | Povrchová úprava | Obj. číslo  |
|--------|------------------|-------------|
| 600 mm | Poniklovaná      | 71-23499600 |

Súčasť balenia: krúžok 1 ks, zaistovací kolík 3 ks, vodidlo 2 ks, kľúč 2 ks

**TOP  
KVALITA**
**ZÁMOK CENTRÁLNY BOČNÝ**

| Dĺžka  | Povrchová úprava | Obj. číslo  |
|--------|------------------|-------------|
| 600 mm | Poniklovaná      | 71-23747600 |

Súčasť balenia: krúžok 1 ks, zaistovací kolík 3 ks, vodidlo 2 ks, kľúč 2 ks

**PRIAZNIVÁ  
CENA**
**ZÁMOK CENTRÁLNY ČELNÝ**

| Dĺžka  | Povrchová úprava | Obj. číslo |
|--------|------------------|------------|
| 600 mm | Poniklovaná      | 62-1679    |

Súčasť balenia: krúžok 1 ks, zaistovací kolík 3 ks, vodidlo 2 ks, kľúč 2 ks

### ZÁMOK CENTRÁLNY BOČNÝ

| Dĺžka  | Povrchová úprava | Obj. číslo |
|--------|------------------|------------|
| 600 mm | Poniklovaná      | 62-1669    |

Súčasť balenia: krúžok 1 ks, zaistovací kolík 3 ks, vodidlo 1 ks, kľúč 2 ks

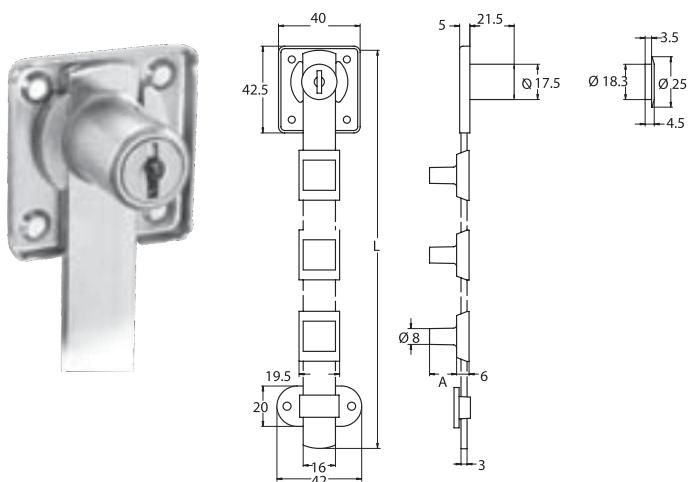

### ZÁMOK NA POSUVNÉ DVERE

| Povrchová úprava | Obj. číslo  |
|------------------|-------------|
| Poniklovaná      | 71-23465600 |

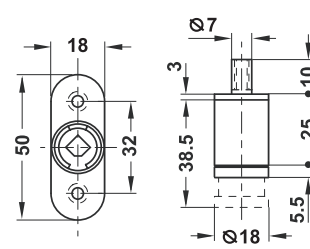

### VLOŽKA MIX

| Povrchová úprava | Obj. číslo  |
|------------------|-------------|
| Poniklovaná      | 71-21040600 |

### ZÁMOK UNIVERZÁLNY

| Hrúbka dverí | Povrchová úprava | Obj. číslo  |
|--------------|------------------|-------------|
| do 17 mm     | Poniklovaná      | 71-23588600 |

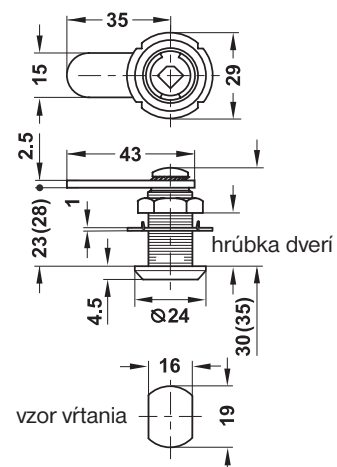

### VLOŽKA MIX

| Povrchová úprava | Obj. číslo  |
|------------------|-------------|
| Poniklovaná      | 71-21040600 |

### KLÚČOVÝ SYSTÉM SYMO 3000

- umožňuje vytvoriť rôzne variácie podľa potrieb užívateľa
- vložky sú opakovane vymeniteľné

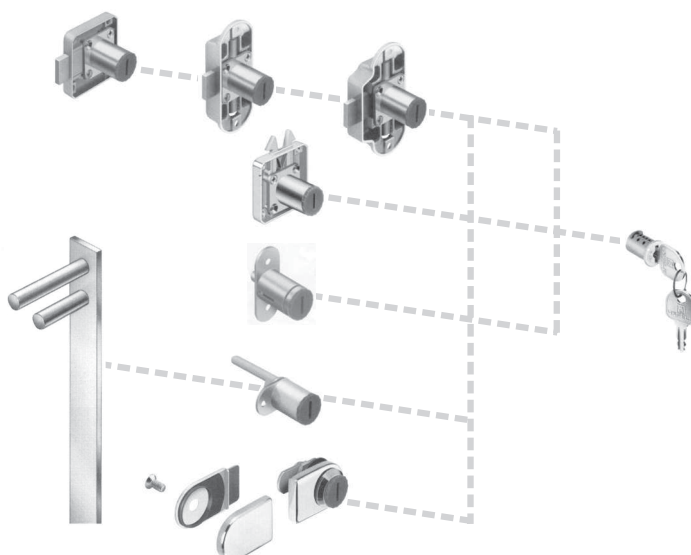

## 8.1 DOPLNKY VSTAVANÝCH SKRÍŇ

# DOPLNKY VSTAVANÝCH SKRÍŇ

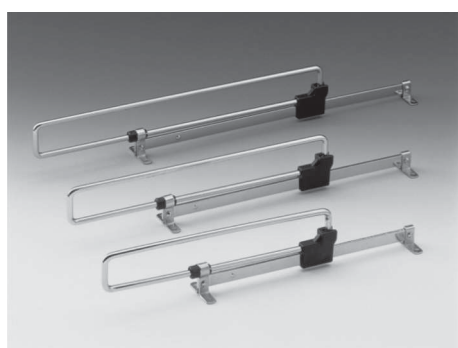
**PRIAZNIVÁ  
CENA** **1**

### VEŠIAK SKLOPNÝ

| Šírka skrine | Povrchová úprava | Obj. číslo |
|--------------|------------------|------------|
| 450-600 mm   | Chróm/čierna     | 62-1045    |
| 600-830 mm   | Chróm/čierna     | 62-1060    |
| 830-1150 mm  | Chróm/čierna     | 62-1083    |

**PRIAZNIVÁ  
CENA** **1**

### VEŠIAK SKLOPNÝ (hliník)

| Šírka skrine | Rozmery                 | Obj. číslo  |
|--------------|-------------------------|-------------|
| 770-1200 mm  | 765-1165 x 100 x 840 mm | 20-00006101 |

**TOP  
KVALITA**

### VEŠIAK SKLOPNÝ (hliník)

| Šírka skrine | Rozmery                 | Obj. číslo  |
|--------------|-------------------------|-------------|
| 770-1200 mm  | 765-1165 x 140 x 850 mm | 71-80520557 |

### VEŠIAK VÝSUVNÝ

| Dĺžka  | Povrchová úprava | Obj. číslo  |
|--------|------------------|-------------|
| 300 mm | Chróm            | 24-17102300 |
| 350 mm | Chróm            | 24-17102350 |
| 400 mm | Chróm            | 24-17102400 |
| 450 mm | Chróm            | 13-0194     |
| 500 mm | Chróm            | 13-0650     |

### VEŠIAK NA KRAVATY

| Šírka  | Povrchová úprava | Obj. číslo  |
|--------|------------------|-------------|
| 425 mm | Nikel            | 71-80720743 |

### VEŠIAK NA KRAVATY (32 ks) PLASTOVÝ

| Rozmery     | Povrchová úprava | Obj. číslo  |
|-------------|------------------|-------------|
| 500 x 76 mm | Běžová           | 71-80721940 |

**VEŠIAK NA OPASKY (8 ks) PLASTOVÝ**

| Rozmery     | Povrchová úprava | Obj. číslo  |
|-------------|------------------|-------------|
| 500 x 76 mm | Transparentná    | 71-80725950 |



**KÔŠ ŠATNÍKOVÝ VÝSUVNÝ**

| Šírka      | Výška  | Povrchová úprava | Obj. číslo  |
|------------|--------|------------------|-------------|
| 340-390 mm | 150 mm | Šedá             | 20-06215240 |
| 440-490 mm | 150 mm | Šedá             | 20-06215250 |
| 540-590 mm | 150 mm | Šedá             | 20-06215260 |



**KÔŠ ŠATNÍKOVÝ VÝSUVNÝ**

| Šírka  | Výška  | Povrchová úprava | Obj. číslo  |
|--------|--------|------------------|-------------|
| 427 mm | 185 mm | Biela            | 71-54494521 |
| 427 mm | 285 mm | Biela            | 71-54494530 |

**LIŠTA VODIACA**

| Dĺžka  | Povrchová úprava | Obj. číslo  |
|--------|------------------|-------------|
| 500 mm | Biela            | 71-54494718 |

**DRŽIAK NA TOPÁNKY VÝSUVNÝ**

| Rozmery            | Povrchová úprava | Obj. číslo  |
|--------------------|------------------|-------------|
| 520-630x450x115 mm | Biela            | 20-30000010 |

**DRŽIAK NA TOPÁNKY**

| Rozmery           | Povrchová úprava | Obj. číslo  |
|-------------------|------------------|-------------|
| 420 x 50 x 225 mm | Biela            | 71-54443210 |

**DRŽIAK NA TOPÁNKY**

| Rozmery      | Povrchová úprava | Obj. číslo  |
|--------------|------------------|-------------|
| 414 x 220 mm | Biela            | 71-54443220 |

**DRŽIAK NA TOPÁNKY PLASTOVÝ**

| Typ           | Povrchová úprava | Obj. číslo  |
|---------------|------------------|-------------|
| Jednopolicový | Biela            | 71-89214719 |
| Dvojpolícový  | Biela            | 71-89214728 |

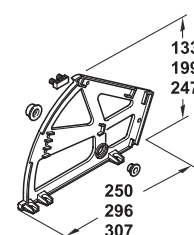
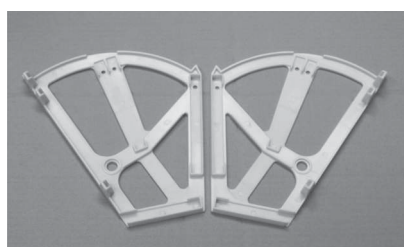
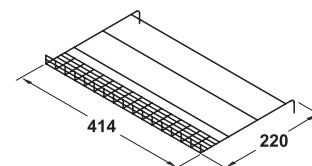
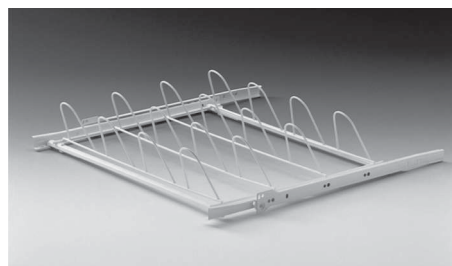

## 9.1 LED REFLEKTORY



## LED REFLEKTORY

| Model  | Farba svetla | Príkon | Obj. číslo  |
|--------|--------------|--------|-------------|
| RC1000 | teplá        | 8 W    | 24-00010000 |
| RC1060 | studená      | 8 W    | 24-00001000 |
| RC2000 | teplá        | 14 W   | 24-00002000 |
| RC2060 | studená      | 14 W   | 24-00002060 |
| RC4000 | teplá        | 18 W   | 24-00004000 |
| RC4060 | studená      | 18 W   | 24-00004060 |
| RC5000 | teplá        | 24 W   | 24-00005000 |
| RC5060 | studená      | 24 W   | 24-00005060 |

## 9.2 SVIETIDLÁ, OSVETLENIE PRE BYTOVÉ ZARIADENIA



LED PÁSKA

PRÍVODNÝ KÁBEL

PREPOJOVACÍ  
KÁBEL

KLIP KONEKTOR

## SVIETIDLO NA HRANU SKLA

| Farba svetla | Dĺžka mm | šírka | Výška | Príkon | Obj. číslo  |
|--------------|----------|-------|-------|--------|-------------|
| Teplá biela  | 563      | 12    | 15 mm | 2,5 W  | 71-83374050 |
| Teplá biela  | 863      | 12    | 15 mm | 4 W    | 71-83374051 |

## LED páska so 150 LED diodami

| Farba svetla                    | napätie | Príkon | Obj. číslo  |
|---------------------------------|---------|--------|-------------|
| teplá biela, svietivosť 3,200 K | 12 V    | 40 W   | 71-83373400 |
| chladná biela, svietiv. 6,500 K | 12 V    | 40 W   | 71-83373410 |
| modrá                           | 12 V    | 40 W   | 71-83373420 |
| červená                         | 12 V    | 40 W   | 71-83373430 |

## LED páska so 300 LED diodami

| Farba svetla                    | napätie | Príkon | Obj. číslo  |
|---------------------------------|---------|--------|-------------|
| teplá biela, svietivosť 3,200 K | 12 V    | 24 W   | 71-83373330 |
| chladná biela, svietiv. 6,500 K | 12 V    | 24 W   | 71-83373340 |
| modrá                           | 12 V    | 24 W   | 71-83373350 |
| červená                         | 12 V    | 24 W   | 71-83373360 |

## SPÍNAČE

| Popis     | rozmer     | Farba      | Obj. číslo  |
|-----------|------------|------------|-------------|
| senzorový | 60 x 13 mm | strieborný | 71-83389040 |
| spínač    | 30 x 13 mm | čierny     | 71-83389044 |
| pohybový  | 60 x 13 mm | strieborný | 71-83389043 |

## PRÍSLUŠENSTVO

|                            | Dĺžka | Obj. číslo  |
|----------------------------|-------|-------------|
| Prívodný kábel             | 2 m   | 71-83374718 |
| Prepojovací kábel          | 0,5 m | 71-83374719 |
| Klip konektor na LED pásku |       | 71-83374720 |

**DRIVER TRANSFORMÁTOR**

| napätie | prikon | Obj. číslo  |
|---------|--------|-------------|
| 12 V    | 30 W   | 71-83374901 |
| 12 V    | 15 W   | 71-83374902 |
| 12 V    | 30 W   | 71-83374903 |



**Stropné svietidlá**

| napätie | prikon | farba svetla                    | Obj. číslo  |
|---------|--------|---------------------------------|-------------|
| 12 V    | 1,7 kW | chladná biela, svietiv. 6,500 K | 71-83373000 |
| 12 V    | 1,5 kW | chladná biela, svietiv. 5,000 K | 71-83373200 |
| 12 V    | 1,5 kW | teplá biela, svietivosť 3,200 K | 71-83373210 |



**Svietidlá pre povrchovú montáž**

| napätie | prikon | upevnenie        | Obj. číslo  |
|---------|--------|------------------|-------------|
| 12 V    | 2 W    | povrchová montáž | 71-83374100 |
| 12 V    | 2 W    | montáž vŕtaním   | 71-83374110 |



**POLICA SVIETIACA**

| Dĺžka police | Výška | Povrchová úprava | Obj. číslo |
|--------------|-------|------------------|------------|
| 450 mm       | 50 mm | Šedá RAL 9006    | 62-5005    |
| 600 mm       | 50 mm | Šedá RAL 9006    | 62-5006    |
| 900 mm       | 50 mm | Šedá RAL 9006    | 62-5009    |
| 1200 mm      | 50 mm | Šedá RAL 9006    | 62-5012    |



**POLICA SVIETIACA**

| Dĺžka police | Povrchová úprava | Obj. číslo |
|--------------|------------------|------------|
| 450 mm       | Šedá RAL 9006    | 62-7049    |
| 600 mm       | Šedá RAL 9006    | 62-7069    |
| 900 mm       | Šedá RAL 9006    | 62-7099    |
| 1200 mm      | Šedá RAL 9006    | 62-7012    |

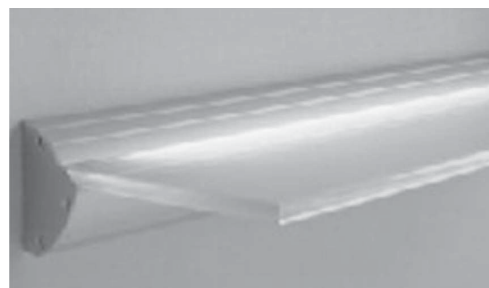

**POLICA SVIETIACA LED**

| Dĺžka police | Povrchová úprava | Obj. číslo |
|--------------|------------------|------------|
| 450 mm       | Šedá RAL 9006    | 62-7104    |
| 600 mm       | Šedá RAL 9006    | 62-7106    |
| 900 mm       | Šedá RAL 9006    | 62-7109    |
| 1200 mm      | Šedá RAL 9006    | 62-7112    |

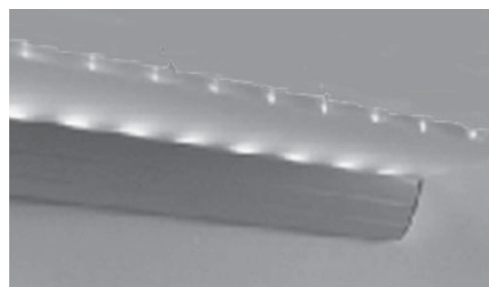

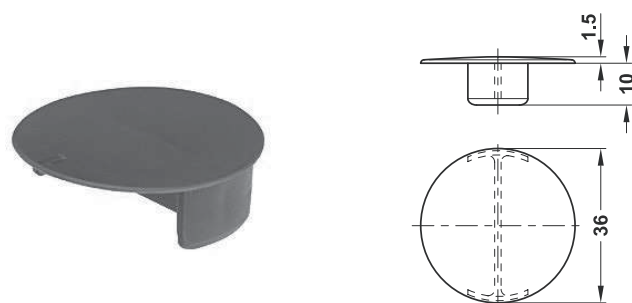
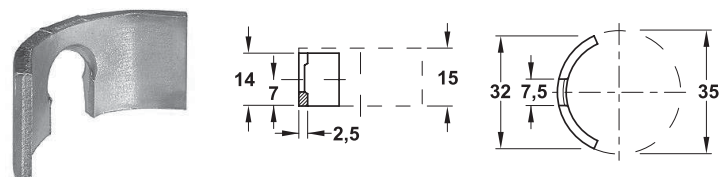
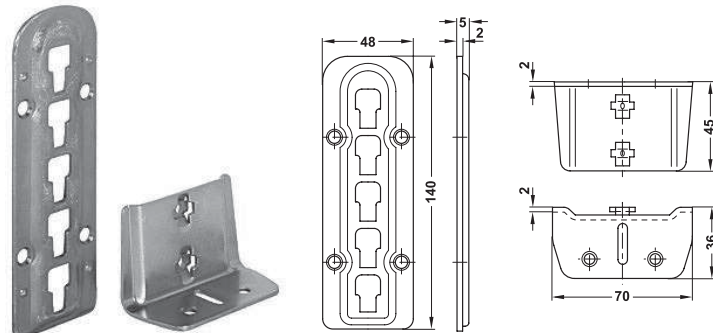
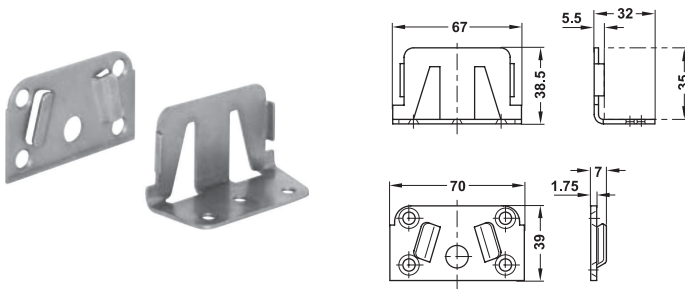
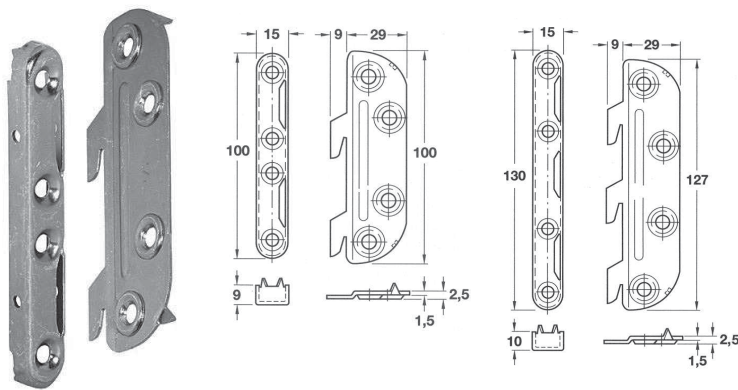
**10.1 SPOJOVACÍ MATERIÁL**

**KOVANIE POSTELOVÉ HREBEŇOVÉ**

| Typ | Povrchová úprava | Obj. číslo  |
|-----|------------------|-------------|
| 100 | Žltý chromát     | 71-27103510 |
| 130 | Žltý chromát     | 71-27103530 |

**KOVANIE POSTELOVÉ STREDOVÉ**

| Povrchová úprava | Obj. číslo  |
|------------------|-------------|
| Žltý chromát     | 71-27303510 |

**KOVANIE POSTELOVÉ STREDOVÉ NASTAVITELNÉ**

| Povrchová úprava | Obj. číslo  |
|------------------|-------------|
| Žltý chromát     | 71-27341540 |

**KOVANIE POSTELOVÉ**

| Povrchová úprava | Obj. číslo  |
|------------------|-------------|
| Žltý chromát     | 71-26051909 |

**KRYTKA PLASTOVÁ**

| Povrchová úprava | Obj. číslo  |
|------------------|-------------|
| Hnedá            | 71-26051196 |



**KOVANIE SPOJOVACIE MAXIFIX**

| Na hrúbku materiálu | Povrchová úprava | Obj. číslo  |
|---------------------|------------------|-------------|
| 24 mm               | Zinok biely      | 71-26286003 |

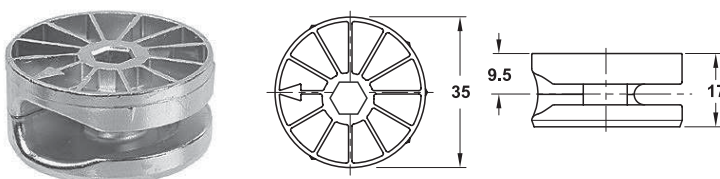

**TIAHLO MAXIFIX**

| Dĺžka L | Povrchová úprava | Obj. číslo  |
|---------|------------------|-------------|
| 29 mm   | Galvanizovaná    | 71-26286911 |
| 49 mm   | Galvanizovaná    | 71-26286912 |

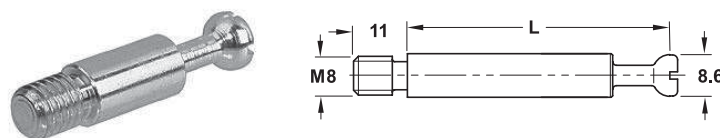

**KOVANIE SPOJOVACIE MINIFIX**

| Na hrúbku materiálu | Povrchová úprava | Obj. číslo  |
|---------------------|------------------|-------------|
| 16 mm               | Galvanizovaná    | 71-26226073 |
| 18 mm               | Galvanizovaná    | 71-26226074 |

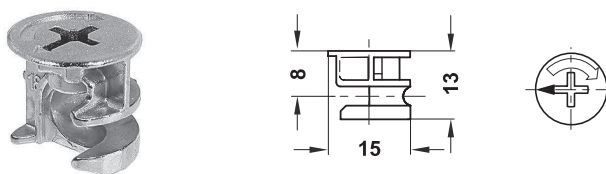

**TIAHLO MINIFIX**

| Dĺžka L | Povrchová úprava | Obj. číslo  |
|---------|------------------|-------------|
| 24 mm   | Galvanizovaná    | 71-26227029 |
| 34 mm   | Galvanizovaná    | 71-26228026 |



**KRYTKA PLASTOVÁ NA MINIFIX**

| Povrchová úprava | Obj. číslo  |
|------------------|-------------|
| Biela            | 71-26224760 |
| Borovica         | 71-26224064 |
| Hnedá            | 71-26224162 |
| Šedá             | 71-26224564 |
| Čierna           | 71-26224368 |

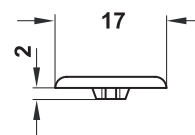

**KOVANIE SPOJOVACIE RAFIX**

| Na hrúbku materiálu | Typ      | Povrchová úprava | Obj. číslo  |
|---------------------|----------|------------------|-------------|
| 16 mm               | Naložený | Hliník biely     | 71-26352203 |
| 16 mm               | Vložený  | Hliník biely     | 71-26350203 |

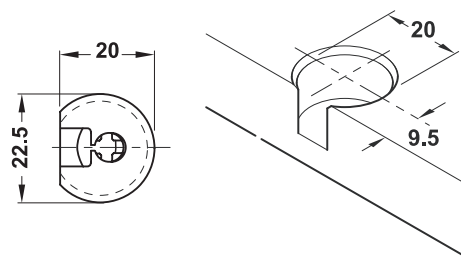

**SKRUTKA RAFIX**

| Povrchová úprava | Obj. číslo  |
|------------------|-------------|
| Galvanizovaná    | 71-26320981 |

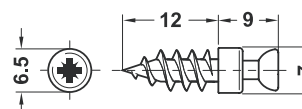

**TIAHLO RAFIX**

| Povrchová úprava | Obj. číslo  |
|------------------|-------------|
| Galvanizovaná    | 71-26324943 |

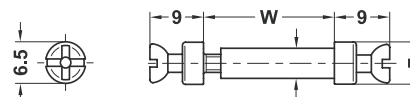

# SPOJOVACÍ MATERIÁL

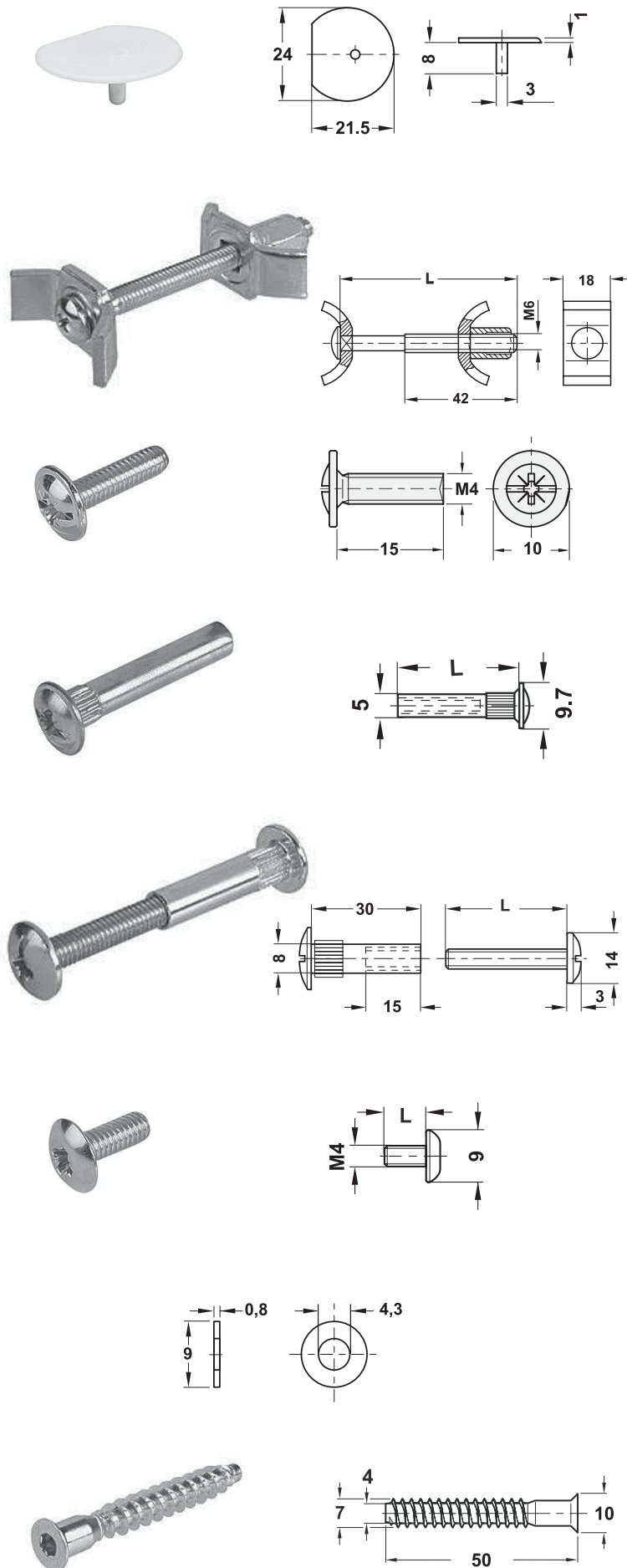

## KRYTKA PLASTOVÁ NA RAFIX

| Povrchová úprava | Obj. číslo  |
|------------------|-------------|
| Hnedá            | 71-26359130 |
| Hliník biely     | 71-26359230 |
| Čierna           | 71-26359330 |
| Béžová           | 71-26359430 |
| Biela            | 71-26359730 |

## KOVANIE SPOJOVACIE NA PRACOVNÉ DOSKY

| Dĺžka L | Povrchová úprava | Obj. číslo  |
|---------|------------------|-------------|
| 65 mm   | Galvanizovaná    | 71-26296211 |
| 150 mm  | Galvanizovaná    | 71-26296220 |

## SKRUTKA SPOJOVACIA M4

| Povrchová úprava | Obj. číslo  |
|------------------|-------------|
| Nikel            | 71-02234157 |

## MATICA SPOJOVACIA M4

| Dĺžka L | Povrchová úprava | Obj. číslo  |
|---------|------------------|-------------|
| 27 mm   | Nikel            | 71-26701715 |
| 35 mm   | Nikel            | 71-26701717 |

## MATICA SPOJOVACIA M6

| Dĺžka L | Povrchová úprava | Obj. číslo  |
|---------|------------------|-------------|
| 20 mm   | Nikel            | 71-26705703 |
| 20 mm   | Čierna           | 71-26705103 |

## SKRUTKY DO ÚCHYTIK

| Povrchová úprava |             | Nikel      |             |
|------------------|-------------|------------|-------------|
| Rozmery          | Obj. číslo  | Rozmery    | Obj. číslo  |
| M4 x 8 mm        | 71-02092711 | M4 x 30 mm | 71-02235305 |
| M4 x 15 mm       | 71-02235154 | M4 x 35 mm | 71-02235350 |
| M4 x 20 mm       | 71-02235207 | M4 x 40 mm | 71-02235403 |
| M4 x 22 mm       | 71-02235225 | M4 x 45 mm | 71-02235458 |
| M4 x 25 mm       | 71-02235252 | M4 x 50 mm | 71-02235501 |

## PODLOŽKA PLASTOVÁ

| Obj. číslo  |
|-------------|
| 71-03701022 |

## KONFIRMÁT

| Rozmery   | Povrchová úprava | Obj. číslo |
|-----------|------------------|------------|
| 7 x 50 mm | Zinok biely      | 44-07050   |
| 7 x 50 mm | Čierna           | 44-07051   |
| 7 x 50 mm | Zinok žltý       | 44-07052   |
| 7 x 50 mm | Zinok            | 44-05050   |

**MATICA ZÁVRTNÁ**

| Rozmery    | Povrchová úprava | Obj. číslo  |
|------------|------------------|-------------|
| M6 x 15 mm | Žltý chromát     | 71-03010564 |
| M8 x 15 mm | Žltý chromát     | 71-03010584 |

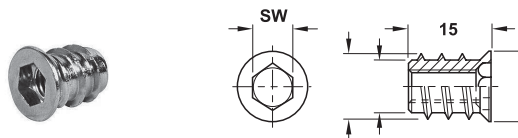

**10.2 SKRUTKY**

**UNIVERZÁLNE SAMOREZNÉ SKRUTKY DO DREVA SO ZAPUSTENOU HLAVOU PZ**

| Rozmery   | Obj. číslo |
|-----------|------------|
| 3,5/45 mm | 44-35045   |
| 3,5/50 mm | 44-35050   |
| 4,12 mm   | 44-40012   |
| 4/16 mm   | 44-40016   |
| 4/20 mm   | 44-40020   |
| 4/25 mm   | 44-40025   |
| 4/30 mm   | 44-40030   |
| 4/35 mm   | 44-40035   |
| 4/40 mm   | 44-40040   |
| 4/45 mm   | 44-40045   |
| 4/50 mm   | 44-40050   |
| 4/60 mm   | 44-40060   |
| 4/70 mm   | 44-40070   |
| 4,5/16 mm | 44-45016   |
| 4,5/25 mm | 44-45025   |
| 4,5/30 mm | 44-45030   |
| 4,5/35 mm | 44-45035   |
| 4,5/40 mm | 44-45040   |
| 4,5/45 mm | 44-45045   |
| 4,5/50 mm | 44-45050   |
| 4,5/55 mm | 44-45055   |
| 4,5/60 mm | 44-45060   |
| 4,5/70 mm | 44-45070   |
| 4,5/80 mm | 44-45080   |
| 5/25 mm   | 44-50025   |
| 5/30 mm   | 44-50030   |
| 5/35 mm   | 44-50035   |
| 5/40 mm   | 44-50040   |
| 5/45 mm   | 44-50045   |
| 5/50 mm   | 44-50050   |
| 5/60 mm   | 44-50060   |
| 5/70 mm   | 44-50070   |
| 5/80 mm   | 44-50080   |
| 5/90 mm   | 44-50090   |
| 5/100 mm  | 44-50100   |
| 5/110 mm  | 44-50110   |
| 5/120 mm  | 44-50120   |
| 6/30 mm   | 44-60030   |
| 6/35 mm   | 44-60035   |
| 6/40 mm   | 44-60040   |
| 6/45 mm   | 44-60045   |
| 6/50 mm   | 44-60050   |
| 6/60 mm   | 44-60060   |
| 6/70 mm   | 44-60070   |
| 6/80 mm   | 44-60080   |
| 6/90 mm   | 44-60090   |
| 6/100 mm  | 44-60100   |
| 6/110 mm  | 44-60110   |
| 6/120 mm  | 44-60120   |
| 6/130 mm  | 44-60130   |
| 6/140 mm  | 44-60140   |
| 6/150 mm  | 44-60150   |
| 6/160 mm  | 44-60160   |
| 6/180 mm  | 44-60180   |
| 6/200 mm  | 44-60200   |



# SPOJOVACÍ MATERIÁL



## UNIVERZÁLNE SAMOREZNÉ SKRUTKY DO DREVA POZINKOVANÉ PZ

| Rozmery   | Obj. číslo |
|-----------|------------|
| 3,5/16 mm | 44-23516   |
| 3,5/25 mm | 44-23525   |
| 3,5/30 mm | 44-23530   |
| 3,5/35 mm | 44-23535   |
| 4/16 mm   | 44-24016   |
| 4/20 mm   | 44-24020   |
| 4/30 mm   | 44-24030   |
| 4/35 mm   | 44-24035   |
| 4/40 mm   | 44-24040   |
| 4/50 mm   | 44-24050   |
| 4,5/25 mm | 44-14525   |
| 4,5/35 mm | 44-14535   |

## UNIVERZÁLNE SAMOREZNÉ SKRUTKY DO DREVA POZINKOVANÉ TORX

| Rozmery   |            |
|-----------|------------|
| 3/16 mm   | 07-1076594 |
| 3/20 mm   | 07-1076595 |
| 3/25 mm   | 07-1076596 |
| 3/30 mm   | 07-1076597 |
| 3/35 mm   | 07-1076603 |
| 3/40 mm   | 07-1076604 |
| 3,5/16 mm | 07-1076606 |
| 3,5/20 mm | 07-1076607 |
| 3,5/25 mm | 07-1076608 |
| 3,5/30 mm | 07-1076609 |
| 4/16 mm   | 07-1076614 |
| 4/20 mm   | 07-1076615 |
| 4/25 mm   | 07-1076616 |
| 4/30 mm   | 07-1076617 |
| 4/35 mm   | 07-1076618 |
| 4/40 mm   | 07-1076619 |
| 4/45 mm   | 07-1076620 |
| 4/50 mm   | 07-1076621 |
| 4/60 mm   | 07-1076622 |
| 4/70 mm   | 07-1076623 |
| 4,5/50 mm | 07-1076627 |
| 5/30 mm   | 07-1076632 |
| 5/35 mm   | 07-1076633 |
| 5/40 mm   | 07-1076634 |
| 5/50 mm   | 07-1076635 |
| 5/60 mm   | 07-1076636 |
| 5/70 mm   | 07-1076637 |
| 5/80 mm   | 07-1076638 |
| 5/90 mm   | 07-1076639 |
| 5/100 mm  | 07-1076640 |
| 5/110 mm  | 07-1076641 |
| 5/120 mm  | 07-1076642 |
| 6/80 mm   | 07-1076646 |
| 6/100 mm  | 07-1076648 |
| 6/120 mm  | 07-1076650 |
| 6/130 mm  | 07-1076651 |
| 6/140 mm  | 07-1076652 |
| 6/150 mm  | 07-1076653 |
| 6/160 mm  | 07-1076654 |
| 6/180 mm  | 07-1076655 |
| 6/200 mm  | 07-1076656 |

### 10.3 PODPERKY POLICOVÉ

#### PODPERKA

| Rozmery  | Povrchová úprava | Obj. číslo  |
|----------|------------------|-------------|
| 3 x 3 mm | Nikel            | 71-28243914 |
| 5 x 5 mm | Nikel            | 71-28243905 |
| 5 x 5 mm | Nikel            | 24-37117001 |

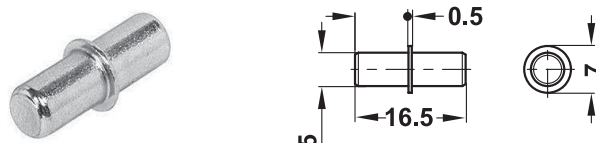

#### PODPERKA

| Rozmery  | Povrchová úprava | Obj. číslo  |
|----------|------------------|-------------|
| 3 x 5 mm | Nikel            | 71-28206706 |
| 3 x 5 mm | Mosadz           | 71-28206500 |

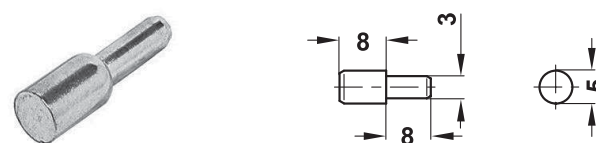

#### PODPERKA S NOSNOSŤOU 100 KG

| Priemer | Povrchová úprava | Obj. číslo  |
|---------|------------------|-------------|
| 7 mm    | Nikel            | 71-28201701 |

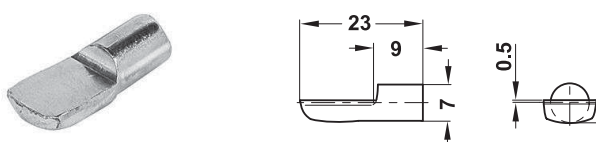

#### PODPERKA NA SKLENENÉ POLICE

| Rozmery  | Povrchová úprava | Obj. číslo  |
|----------|------------------|-------------|
| 3 x 5 mm | Galvanizovaná    | 71-28140712 |
| 5 x 7 mm | Galvanizovaná    | 71-28141966 |

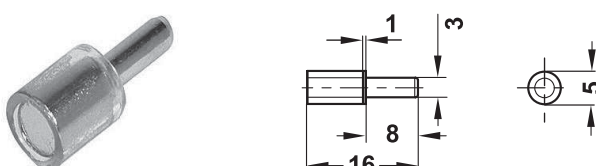

#### PODPERKA NA SKLENENÉ POLICE

| Na hrúbku skla | Povrchová úprava | Obj. číslo  |
|----------------|------------------|-------------|
| do 13 mm       | Nikel            | 71-28220724 |

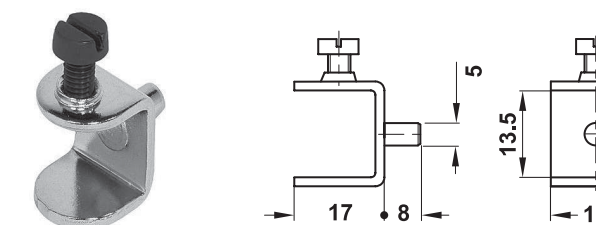

#### PODPERKA NA SKLENENÉ POLICE

| Povrchová úprava | Obj. číslo  |
|------------------|-------------|
| Nikel            | 71-28224730 |

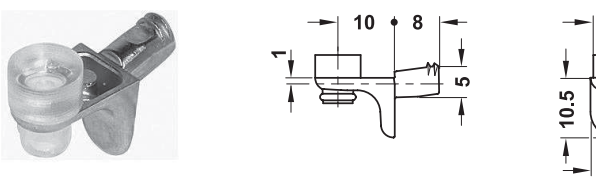

## 11.1 ROLETOVÉ SYSTÉMY



Classic



Top Basic

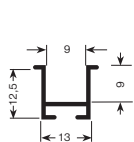
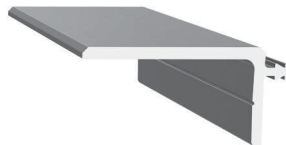
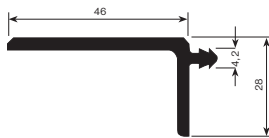
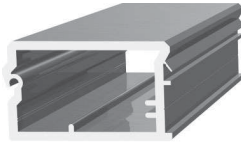
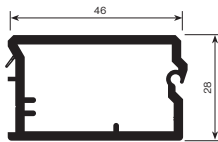
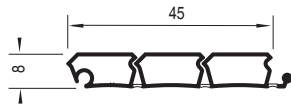

Lišta zápuštná – Classic

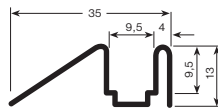
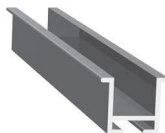

Lišta povrchová – Top Basic



### VODIACI SYSTÉM PLASTOVÝ:

- systém na zafrézovanie – Classic
- nasadené vedenie na naskrutkovanie vo vnútri skrine – Top Basic.

### ROLETKA PLASTOVÁ

| Povrchová úprava | Dĺžka  | Obj. číslo |
|------------------|--------|------------|
| Šedá             | 250 cm | 02-9250    |

### LIŠTA KONCOVÁ NA ÚCHYTKU

| Dĺžka  | Obj. číslo |
|--------|------------|
| 250 cm | 02-9340    |

### LIŠTA KRYCIA

| Dĺžka  | Obj. číslo |
|--------|------------|
| 250 cm | 02-9360    |

### LIŠTA VODIACA

| Typ       | Dĺžka  | Obj. číslo |
|-----------|--------|------------|
| Zápuštná  | 250 cm | 02-9370    |
| Povrchová | 250 cm | 02-9450    |

### BRZDA VERTIKÁLNA

| Obj. číslo |
|------------|
| 02-9680    |

**SLIMÁK VODIACI PÄTCESTNÝ**

| Kapacita | Obj. číslo |
|----------|------------|
| 1590 mm  | 02-9770    |

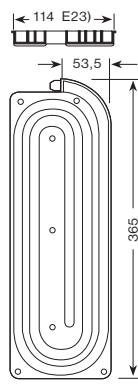

Kapacita slímáka: 1590 mm

**OBLÚK VODIACI 90°**

| Typ       | Obj. číslo |
|-----------|------------|
| Zápusťný  | 02-9690    |
| Povrchový | 02-9950    |

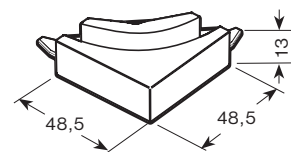
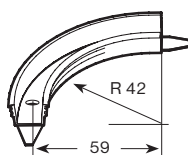

PRÍSLUŠENSTVO

**11.2 ROLETOVÉ SÚPRAVY NA MIERU**

**ROLETOVÉ SÚPRAVY NA MIERU**

Roletový systém RAUVOLET metallic-line 20 a 25 mm.

- Povrchové úpravy: hliník a brúsené antikoro.
- Vysoký užívateľský komfort pri ľahkom a tichom pohybe rolety.
- Exkluzívny povrch z pravého hliníka.
- Roletové súpravy na mieru pripravené na montáž.
- Jednoduchá a rýchla montáž.
- V každom balení dostanete všetky systémové komponenty potrebné na montáž do korpusu spolu s kompletným príslušenstvom.



**RAUVOLET METALLIC-LINE 20 mm**

| Rozmery skrinky | Povrchová úprava | Obj. číslo    |
|-----------------|------------------|---------------|
| 500 x 1000 mm   | Hliník           | 02-773247-400 |
|                 | Antikoro         | 02-773247-300 |
| 600 x 1000 mm   | Hliník           | 02-773257-400 |
|                 | Antikoro         | 02-773257-300 |
| 500 x 1500 mm   | Hliník           | 02-70384-400  |
|                 | Antikoro         | 02-70384-300  |
| 900 x 1000 mm   | Hliník           | 02-773277-400 |
|                 | Antikoro         | 02-773277-300 |
| 600 x 1500 mm   | Hliník           | 02-779088-400 |
|                 | Antikoro         | 02-779088-300 |
| 900 x 1500 mm   | Hliník           | 02-779098-400 |
|                 | Antikoro         | 02-779098-300 |

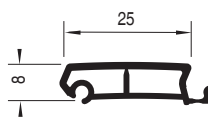
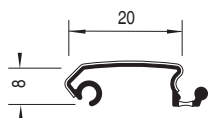

**RAUVOLET METALLIC-LINE 25 mm\***

\* Technické riešenie: ☎ twd-dispečing

## 11.3 TECHNICKÉ PRÍSLUŠENSTVO NÁBYTKU

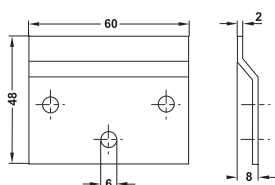
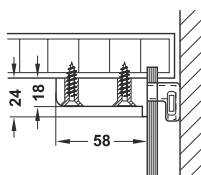
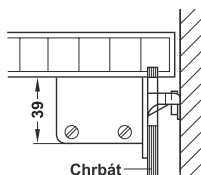
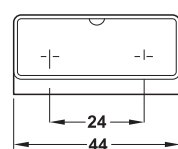
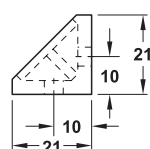
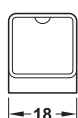
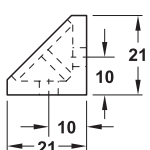
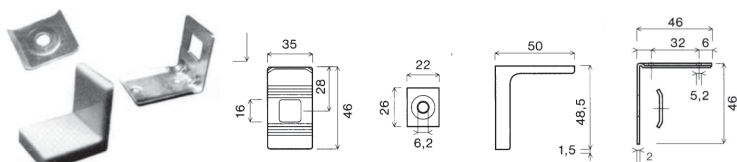

4

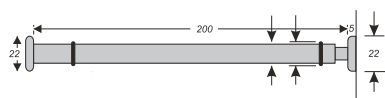
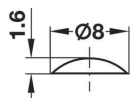

### UHOLNÍK REKTIFIKAČNÝ S KRYTOM

| Povrchová úprava          | Obj. číslo  |
|---------------------------|-------------|
| Zinok + plast biely       | 62-7001     |
| Zinok + plast svetlý buk  | 62-7002     |
| Zinok + plast jelša       | 62-7003     |
| Zinok + plast čerešňa     | 62-7004     |
| Zinok + plast tmavo hnedý | 62-7005     |
| Béžová                    | 24-48104005 |
| Biela                     | 24-48104003 |
| Čierna                    | 24-48104001 |
| Hnedá                     | 24-48104003 |

### UHOLNÍK ROHOVÝ PLASTOVÝ

| Šírka | Povrchová úprava | Obj. číslo  |
|-------|------------------|-------------|
| 17 mm | Biela            | 24-05509002 |
| 17 mm | Béžová           | 24-05509013 |
| 17 mm | Hnedá            | 24-05509001 |
| 18 mm | Biela            | 71-26256708 |
| 18 mm | Béžová           | 71-26256404 |
| 18 mm | Hnedá            | 71-26256155 |
| 42 mm | Biela            | 24-05510002 |
| 42 mm | Béžová           | 24-05509001 |
| 42 mm | Hnedá            | 24-05510001 |
| 44 mm | Biela            | 71-26255710 |
| 44 mm | Béžová           | 71-26255425 |
| 44 mm | Hnedá            | 71-26255112 |

### KOVANIE ZÁVESNÉ

| Typ   | Obj. číslo  |
|-------|-------------|
| Pravý | 71-27000700 |
| Ľavý  | 71-27000701 |

### PLECH

| Povrchová úprava | Obj. číslo  |
|------------------|-------------|
| Galvanizovaná    | 71-29008900 |

### TLMIACA BUBLINA

| Rozmery     | Povrchová úprava     | Obj. číslo  |
|-------------|----------------------|-------------|
| Ø 8         | Transparentná        | 71-35621420 |
| Ø 8 x 10 mm | Plast čierny + biely | 56-0438     |

### DRŽIAK SKLENENÝCH POLÍC - DO STENY

| Šírka police | Povrchová úprava | Obj. číslo  |
|--------------|------------------|-------------|
| 200 mm       | Chróm            | 17-24852005 |
| 200 mm       | Matný chróm      | 17-24852019 |

### DRŽIAK SKLENENÝCH POLÍC - DO DTD

| Šírka police | Povrchová úprava | Obj. číslo  |
|--------------|------------------|-------------|
| 200 mm       | Chróm            | 17-24852105 |
| 200 mm       | Matný chróm      | 17-24852119 |



## 11.4 KONZOLY

### DRŽIAK POLÍC

| Na hrúbku police | Povrchová úprava | Obj. číslo  |
|------------------|------------------|-------------|
| 19 mm            | Galvanizovaná    | 71-28332014 |
| 22 mm            | Galvanizovaná    | 71-28332023 |

### DRŽIAK POLICE REX

| Rozmer    | Obj. číslo |
|-----------|------------|
| 12/100 mm | 62-5100    |

### KONZOLY

| rozmer     | farba | Obj. číslo  |
|------------|-------|-------------|
| 75/100 mm  | biela | 24-39105001 |
| 75/100 mm  | hnedá | 24-39105010 |
| 75/100 mm  | metal | 99-2169     |
| 100/125 mm | biela | 24-39105002 |
| 100/125 mm | hnedá | 24-39105020 |
| 100/125 mm | metal | 99-2170     |
| 125/150 mm | biela | 24-39105003 |
| 125/150 mm | hnedá | 24-39105030 |
| 125/150 mm | metal | 99-2171     |
| 150/175 mm | biela | 99-0172     |
| 150/175 mm | hnedá | 99-1172     |
| 150/175 mm | metal | 99-2172     |
| 150/200 mm | biela | 24-39105004 |
| 150/200 mm | hnedá | 24-39105040 |
| 150/200 mm | metal | 99-2173     |
| 200/225 mm | biela | 99-0174     |
| 200/225 mm | hnedá | 99-1174     |
| 200/225 mm | metal | 99-2174     |
| 200/250 mm | biela | 24-39105005 |
| 200/250 mm | hnedá | 24-39105050 |
| 200/250 mm | metal | 99-2175     |
| 250/300 mm | biela | 24-39105006 |
| 250/300 mm | hnedá | 24-39105060 |
| 250/300 mm | metal | 99-2176     |
| 300/350 mm | biela | 24-39105007 |
| 300/350 mm | hnedá | 24-39105070 |
| 300/350 mm | metal | 99-2177     |
| 350/400 mm | biela | 99-0178     |
| 350/400 mm | hnedá | 99-1178     |
| 350/400 mm | metal | 99-2178     |
| 400/450 mm | biela | 99-0179     |
| 400/450 mm | hnedá | 99-1179     |
| 400/450 mm | metal | 99-2179     |

### KONZOLY SKLOPNÉ

| rozmer     | farba | Obj. číslo |
|------------|-------|------------|
| 200/200 mm | biela | 99-0166    |
| 300/300 mm | biela | 99-0167    |
| 400/400 mm | biela | 99-0168    |



## 11.5 KOŠE NA ODPADKY

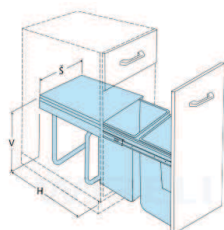

Š (mm) 260  
H (mm) 480  
V (mm) 400

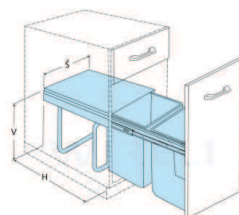

Š (mm) 330  
H (mm) 480  
V (mm) 400

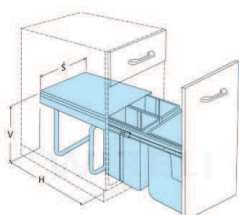

Š (mm) 330  
H (mm) 480  
V (mm) 400

**TOP  
KVALITA**

## KÔŠ NA ODPADKY

| Objem              | Rozmery        | Farba | Obj. číslo  |
|--------------------|----------------|-------|-------------|
| 1x20 l<br>+ 1x10 l | 260x480x400 mm | šedá  | 20-10071106 |
| 2x20 l             | 330x480x400 mm | šedá  | 20-10071126 |
| 2x10 l<br>+ 1x20 l | 330x480x400 mm | šedá  | 20-07122602 |

## KÔŠ NA ODPADKY

| Objem | Rozmery     | Povrchová úprava | Obj. číslo  |
|-------|-------------|------------------|-------------|
| 26 l  | 300x280x320 | Šedá             | 24-23105002 |
| 11 l  | 250x320 mm  | Biela            | 62-6270     |
| 11 l  | 250x320 mm  | Antikoro         | 62-2724     |

**PRIAZNIVÁ  
CENA** 1

## KÔŠ NA ODPADKY

| Objem | Rozmery     | Povrchová úprava | Obj. číslo  |
|-------|-------------|------------------|-------------|
| 26 l  | 300x280x320 | Šedá             | 24-23105002 |
| 11 l  | 250x320 mm  | Biela            | 62-6270     |
| 11 l  | 250x320 mm  | Antikoro         | 62-2724     |

**PRIAZNIVÁ  
CENA** 1

## KÔŠ NA ODPADKY

| Objem  | Rozmery        | Povrchová úprava | Obj. číslo |
|--------|----------------|------------------|------------|
| 2x18 l | 340x460x375 mm | Biela            | 62-6221    |

## 11.6 OSTATNÉ

### DRŽIAK POLÍC\*

| Na hrúbku police | Povrchová úprava | Obj. číslo  |
|------------------|------------------|-------------|
| 6 - 25 mm        | Antikoro         | 17-05095019 |
| 6 - 25 mm        | Matný nikel      | 17-05095027 |
| 6 - 25 mm        | Chróm            | 17-05095029 |
| 6 - 25 mm        | Matný chróm      | 17-05095030 |

\* Balenie v kusoch

### DRŽIAK POLÍC\*

| Na hrúbku police | Povrchová úprava | Obj. číslo  |
|------------------|------------------|-------------|
| 6 - 38 mm        | Antikoro         | 17-05095519 |
| 6 - 38 mm        | Mosadz           | 17-05095523 |
| 6 - 38 mm        | Chróm            | 17-05095529 |
| 6 - 38 mm        | Matný chróm      | 17-05095531 |

\* Balenie v pároch

### DRŽIAK POLÍC

| Na hrúbku police | Povrchová úprava | Obj. číslo |
|------------------|------------------|------------|
| do 10 mm         | Chróm            | 99-5767    |
| do 10 mm         | Čierna           | 99-5769    |
| do 10 mm         | Zlatá            | 99-5776    |
| do 10 mm         | Nikel brúsený    | 99-6477    |

### DRŽIAK POLÍC

| Na hrúbku police | Povrchová úprava | Obj. číslo |
|------------------|------------------|------------|
| do 10 mm         | Chróm            | 99-4944    |
| do 10 mm         | Čierna           | 99-4945    |
| do 10 mm         | Zlatá            | 99-4946    |
| do 10 mm         | Nikel brúsený    | 99-6223    |

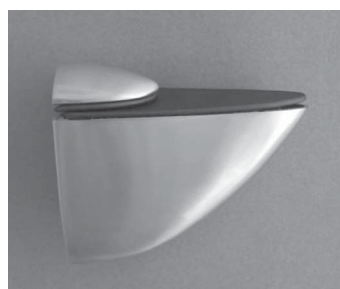

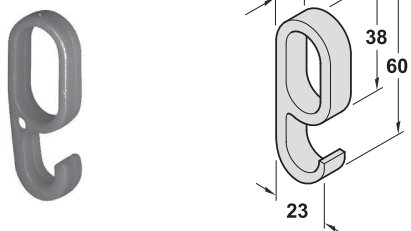
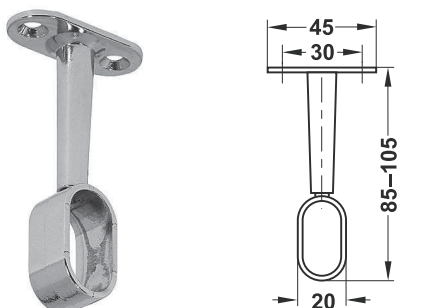
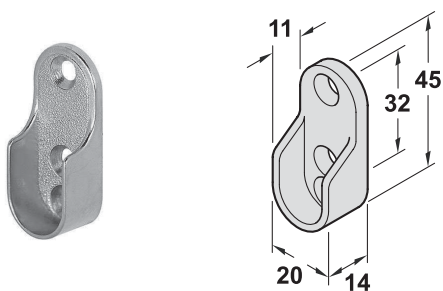

## TYČ VEŠIAKOVÁ

PRIAZNIVÁ  
CENA 1

| Rozmery    | Dĺžka | Povrchová úprava | Obj. číslo |
|------------|-------|------------------|------------|
| 15 x 22 mm | 2 m   | Nikel            | 62-1200    |
| 15 x 22 mm | 3 m   | Nikel            | 62-1041    |
| 15 x 30 mm | 2 m   | Nikel            | 62-4200    |
| 15 x 30 mm | 3 m   | Nikel            | 62-3300    |

## TYČ VEŠIAKOVÁ

TOP  
KVALITA

| Rozmery    | Dĺžka | Povrchová úprava | Obj. číslo  |
|------------|-------|------------------|-------------|
| 15 x 30 mm | 2 m   | Strieborná       | 99-2001     |
| 15 x 30 mm | 2 m   | Zlatá            | 99-2004     |
| 15 x 30 mm | 2 m   | Biela            | 99-2006     |
| 15 x 30 mm | 2 m   | Bronz            | 99-2002     |
| 15 x 30 mm | 3 m   | CR               | 24-13102503 |
| D 25       | 3 m   | CR               | 24-13105009 |

## DRŽIAK VEŠIAKOVEJ TYČE

PRIAZNIVÁ  
CENA 1

| Povrchová úprava |        | Obj. číslo  |
|------------------|--------|-------------|
| Nikel            | oválny | 62-1506     |
| Nikel            | oválny | 71-80333758 |
| Nikel            | oválny | 24-12102001 |
| Nikel            | D25    | 24-12114001 |

## DRŽIAK VEŠIAKOVEJ TYČE

TOP  
KVALITA

| Povrchová úprava | Obj. číslo |
|------------------|------------|
| Strieborná       | 99-2007    |
| Bronzová         | 99-2008    |
| Zlatá            | 99-2009    |
| Biela            | 99-2010    |

## ZÁVES VEŠIAKOVEJ TYČE

| Povrchová úprava | Obj. číslo |
|------------------|------------|
| Zlatá            | 99-2012    |
| Bronzová         | 99-2013    |
| Strieborná       | 99-2014    |
| Biela            | 99-2015    |

## HÁK VEŠIAKOVÝ PLASTOVÝ

| Povrchová úprava | Obj. číslo  |
|------------------|-------------|
| Čierna           | 71-80329317 |

## VÝSUV NA KLÁVESNICU

| Rozmery        | Povrchová úprava | Obj. číslo  |
|----------------|------------------|-------------|
| 550 x 260 mm   | Šedá             | 62-5750     |
| + výsuv na myš | Šedá             | 62-5705     |
| 350 mm         | Šedá             | 24-32102001 |

**VÝSUV NA KLÁVESNICU KH 2**

| Rozmery    | Povrchová úprava | Obj. číslo |
|------------|------------------|------------|
| 512x603 mm | Šedá RAL 9006 G  | 80-30036   |

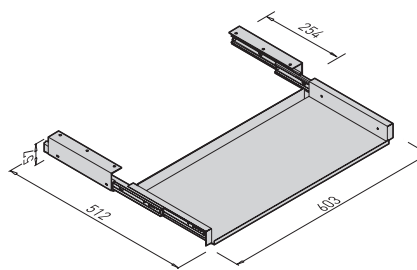

**POLICA POD PC**

| Rozmery       | Povrchová úprava | Obj. číslo |
|---------------|------------------|------------|
| 520x215x80 mm | Šedá RAL 9006 G  | 80-30056   |

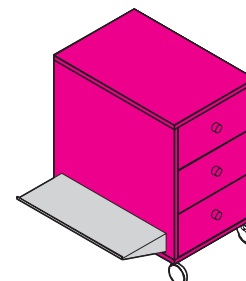
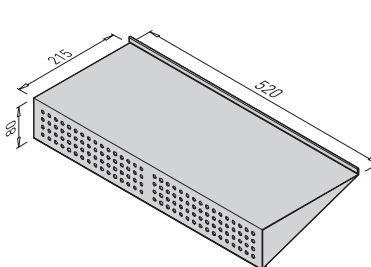

**NOSNÉ TYČE POLICE POD PC**

| Dĺžka  | Povrchová úprava | Obj. číslo |
|--------|------------------|------------|
| 633 mm | Šedá RAL 9006 G  | 80-30066   |

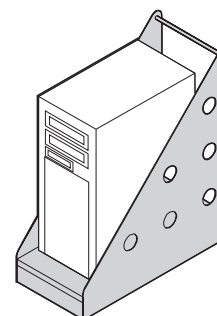
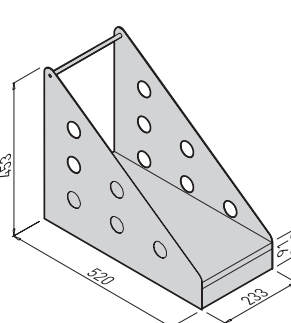

**KONTAJNER NA PC**

| Rozmery        | Povrchová úprava | Obj. číslo |
|----------------|------------------|------------|
| 520x453x233 mm | Šedá RAL 9006 G  | 80-30641   |

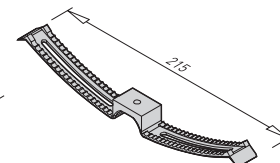
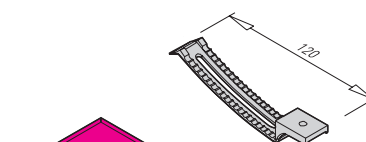

**DRŽIAK VODIČOV**

| Typ        | Dĺžka  | Povrchová úprava | Obj. číslo |
|------------|--------|------------------|------------|
| Jednoduchý | 120 mm | Plast RAL 7035   | 80-30048   |
| Dvojitý    | 215 mm | Plast RAL 7035   | 80-20640   |

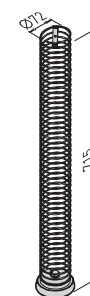
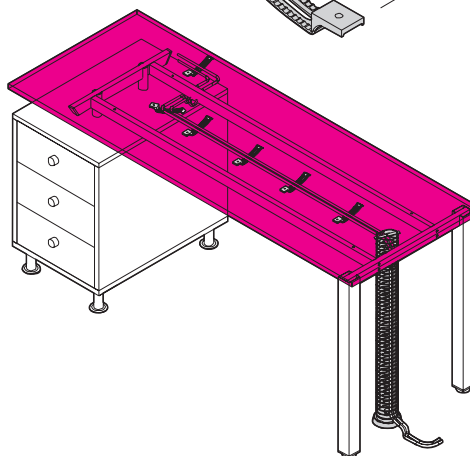

**KRYT VODIČOV**

| Priemer | Výška  | Povrchová úprava | Obj. číslo |
|---------|--------|------------------|------------|
| 72 mm   | 715 mm | Šedá RAL 9006 G  | 80-30077   |

**POLICA NA VODIČE**

| Rozmery       | Povrchová úprava | Obj. číslo |
|---------------|------------------|------------|
| 300x130x70 mm | Šedá RAL 9006 G  | 80-30525   |

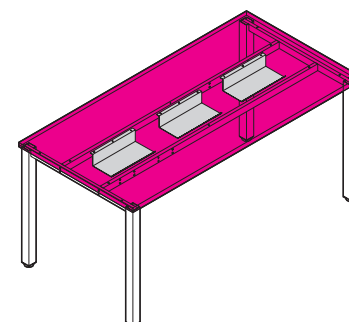
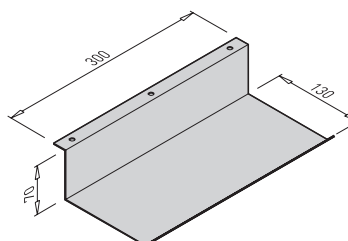

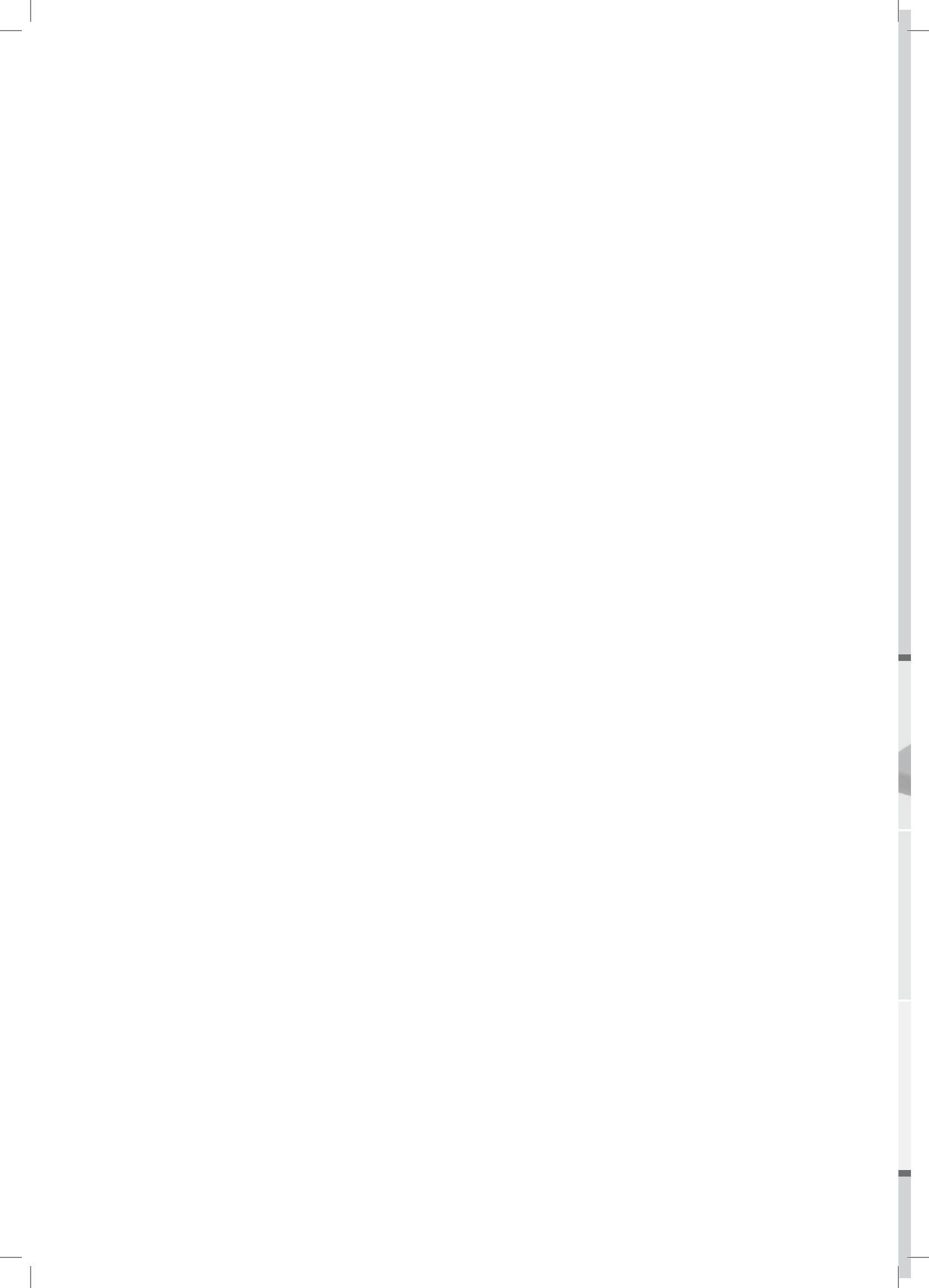

# STAVEBNÉ KOVANIE

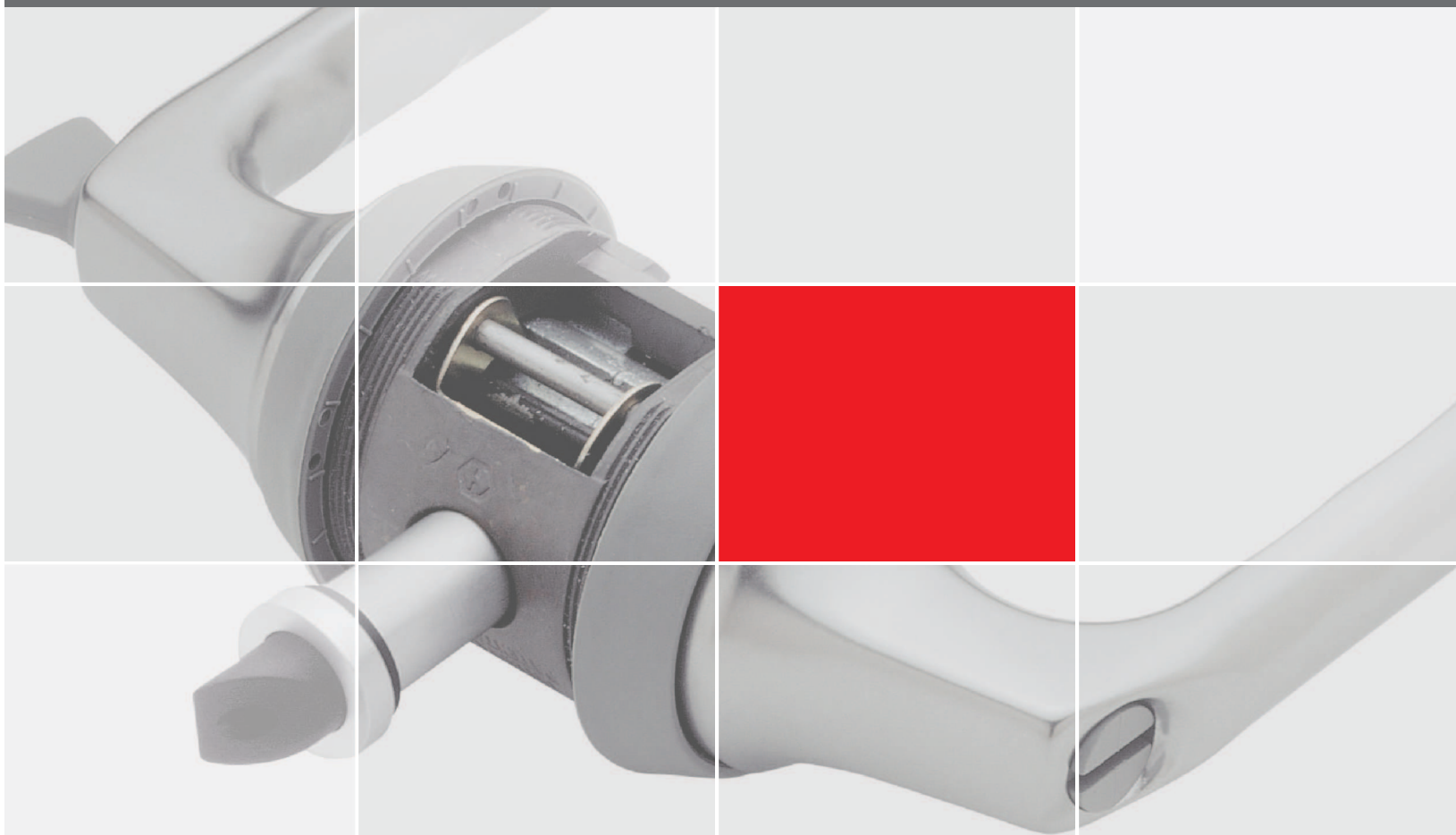

**SIEGENIA AUBI**<sup>®</sup>  
SOLUTIONS INSIDE

# TITAN AF

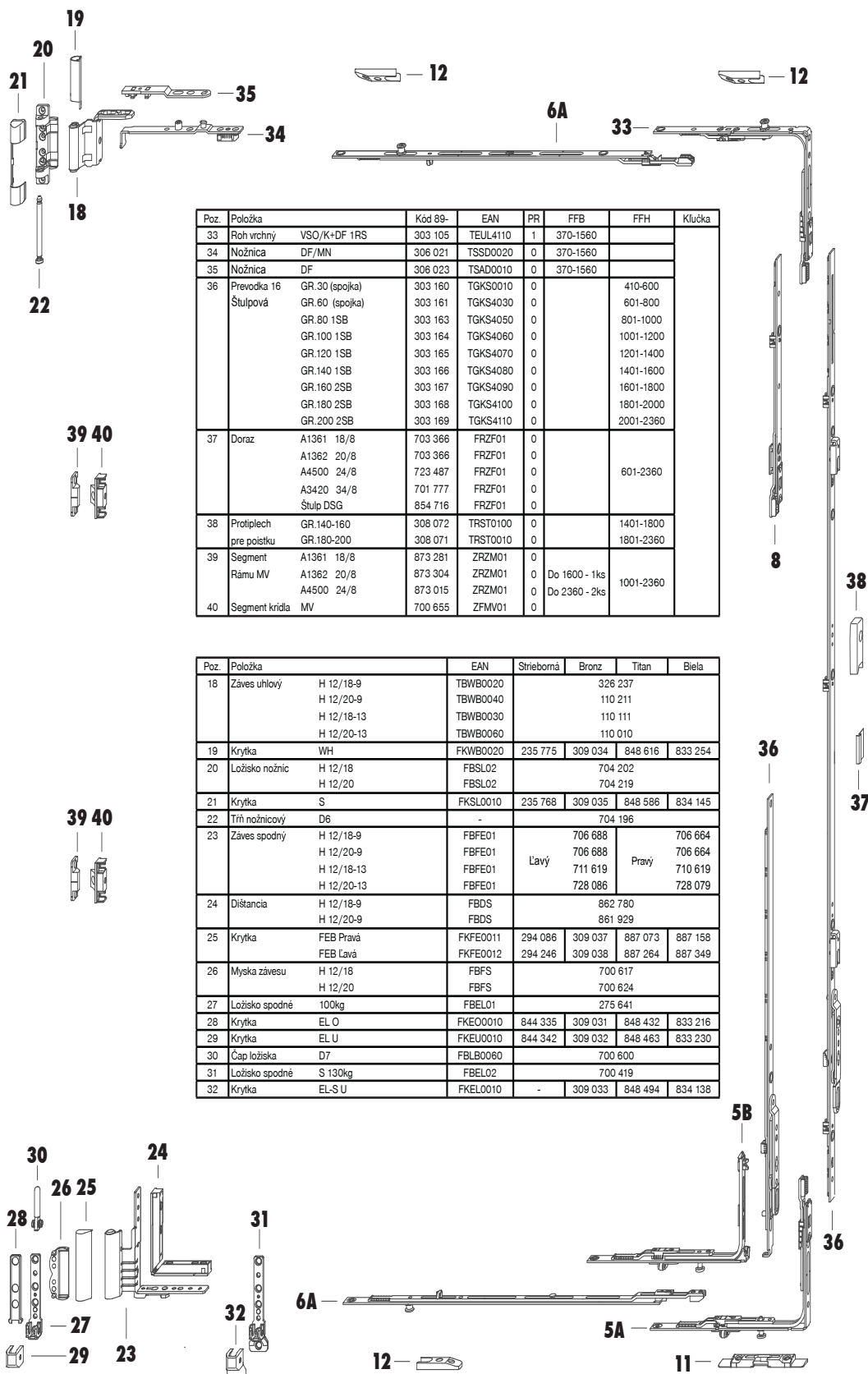
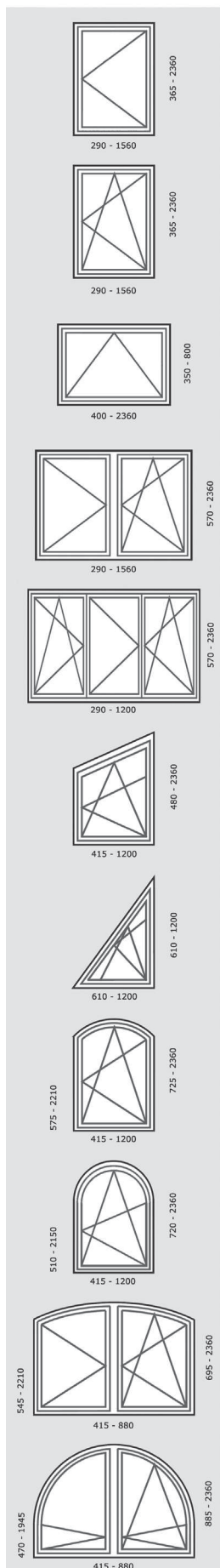
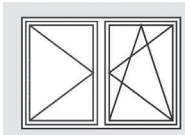

| Poz. | Položka                    | Kód 89- | EAN      | PR | FFB           | FFH       | Kľučka |
|------|----------------------------|---------|----------|----|---------------|-----------|--------|
| 33   | Roh vrchný VSO/K+DF 1RS    | 303 105 | TEUL4110 | 1  | 370-1560      |           |        |
| 34   | Nožnica DF/MN              | 306 021 | TSSD0020 | 0  | 370-1560      |           |        |
| 35   | Nožnica DF                 | 306 023 | TSAD0010 | 0  | 370-1560      |           |        |
| 36   | Prevodka 16 GR.30 (spojka) | 303 160 | TGKS0010 | 0  |               | 410-600   |        |
|      | Štulpová GR.60 (spojka)    | 303 161 | TGKS4030 | 0  |               | 601-800   |        |
|      | GR.80 1SB                  | 303 163 | TGKS4050 | 0  |               | 801-1000  |        |
|      | GR.100 1SB                 | 303 164 | TGKS4060 | 0  |               | 1001-1200 |        |
|      | GR.120 1SB                 | 303 165 | TGKS4070 | 0  |               | 1201-1400 |        |
|      | GR.140 1SB                 | 303 166 | TGKS4080 | 0  |               | 1401-1600 |        |
|      | GR.160 2SB                 | 303 167 | TGKS4090 | 0  |               | 1601-1800 |        |
|      | GR.180 2SB                 | 303 168 | TGKS4100 | 0  |               | 1801-2000 |        |
|      | GR.200 2SB                 | 303 169 | TGKS4110 | 0  |               | 2001-2360 |        |
| 37   | Doraz A1361 18/8           | 703 366 | FRZF01   | 0  |               |           |        |
|      | A1362 20/8                 | 703 366 | FRZF01   | 0  |               |           |        |
|      | A4500 24/8                 | 723 487 | FRZF01   | 0  |               | 601-2360  |        |
|      | A3420 34/8                 | 701 777 | FRZF01   | 0  |               |           |        |
|      | Štulp DSG                  | 854 716 | FRZF01   | 0  |               |           |        |
| 38   | Protiplech GR.140-160      | 308 072 | TRST0100 | 0  |               | 1401-1800 |        |
|      | GR.180-200                 | 308 071 | TRST0010 | 0  |               | 1801-2360 |        |
| 39   | Segment A1361 18/8         | 873 281 | ZRZM01   | 0  |               |           |        |
|      | Rámu MV A1362 20/8         | 873 304 | ZRZM01   | 0  | Do 1600 - 1ks | 1001-2360 |        |
|      | A4500 24/8                 | 873 015 | ZRZM01   | 0  | Do 2360 - 2ks |           |        |
| 40   | Segment krídla MV          | 700 655 | ZFMV01   | 0  |               |           |        |

| Poz. | Položka                | EAN      | Strieborná | Bronz   | Titan   | Bielea  |
|------|------------------------|----------|------------|---------|---------|---------|
| 18   | Záves uhľový H 12/18-9 | TBWB0020 |            |         | 326 237 |         |
|      | H 12/20-9              | TBWB0040 |            |         | 110 211 |         |
|      | H 12/18-13             | TBWB0030 |            |         | 110 111 |         |
|      | H 12/20-13             | TBWB0060 |            |         | 110 010 |         |
| 19   | Krytka WH              | FKWB0020 | 235 775    | 309 034 | 848 616 | 833 254 |
| 20   | Ložisko nožnic H 12/18 | FBSL02   |            |         | 704 202 |         |
|      | H 12/20                | FBSL02   |            |         | 704 219 |         |
| 21   | Krytka S               | FKSL0010 | 235 768    | 309 035 | 848 586 | 834 145 |
| 22   | Tříh nožnicový D6      | -        |            |         | 704 196 |         |
| 23   | Záves spodný H 12/18-9 | FBFE01   |            | 706 688 |         | 706 664 |
|      | H 12/20-9              | FBFE01   |            | 706 688 |         | 706 664 |
|      | H 12/18-13             | FBFE01   | Lavý       | 711 619 |         | 710 619 |
|      | H 12/20-13             | FBFE01   |            | 728 086 |         | 728 079 |
| 24   | Dištancia H 12/18-9    | FBDS     |            |         | 862 780 |         |
|      | H 12/20-9              | FBDS     |            |         | 861 929 |         |
| 25   | Krytka FEB Pravá       | FKFE0011 | 294 086    | 309 037 | 887 073 | 887 158 |
|      | FEB Lavá               | FKFE0012 | 294 246    | 309 038 | 887 264 | 887 349 |
| 26   | Myska závesu H 12/18   | FBFS     |            |         | 700 617 |         |
|      | H 12/20                | FBFS     |            |         | 700 624 |         |
| 27   | Ložisko spodné 100kg   | FBEL01   |            |         | 275 641 |         |
| 28   | Krytka EL O            | FKE00010 | 844 335    | 309 031 | 848 432 | 833 216 |
| 29   | Krytka EL U            | FKEU0010 | 844 342    | 309 032 | 848 463 | 833 230 |
| 30   | Čap ložiska D7         | FBLB0060 |            |         | 700 600 |         |
| 31   | Ložisko spodné S 130kg | FBEL02   |            |         | 700 419 |         |
| 32   | Krytka EL-S U          | FKEL0010 | -          | 309 033 | 848 494 | 834 138 |



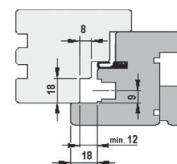
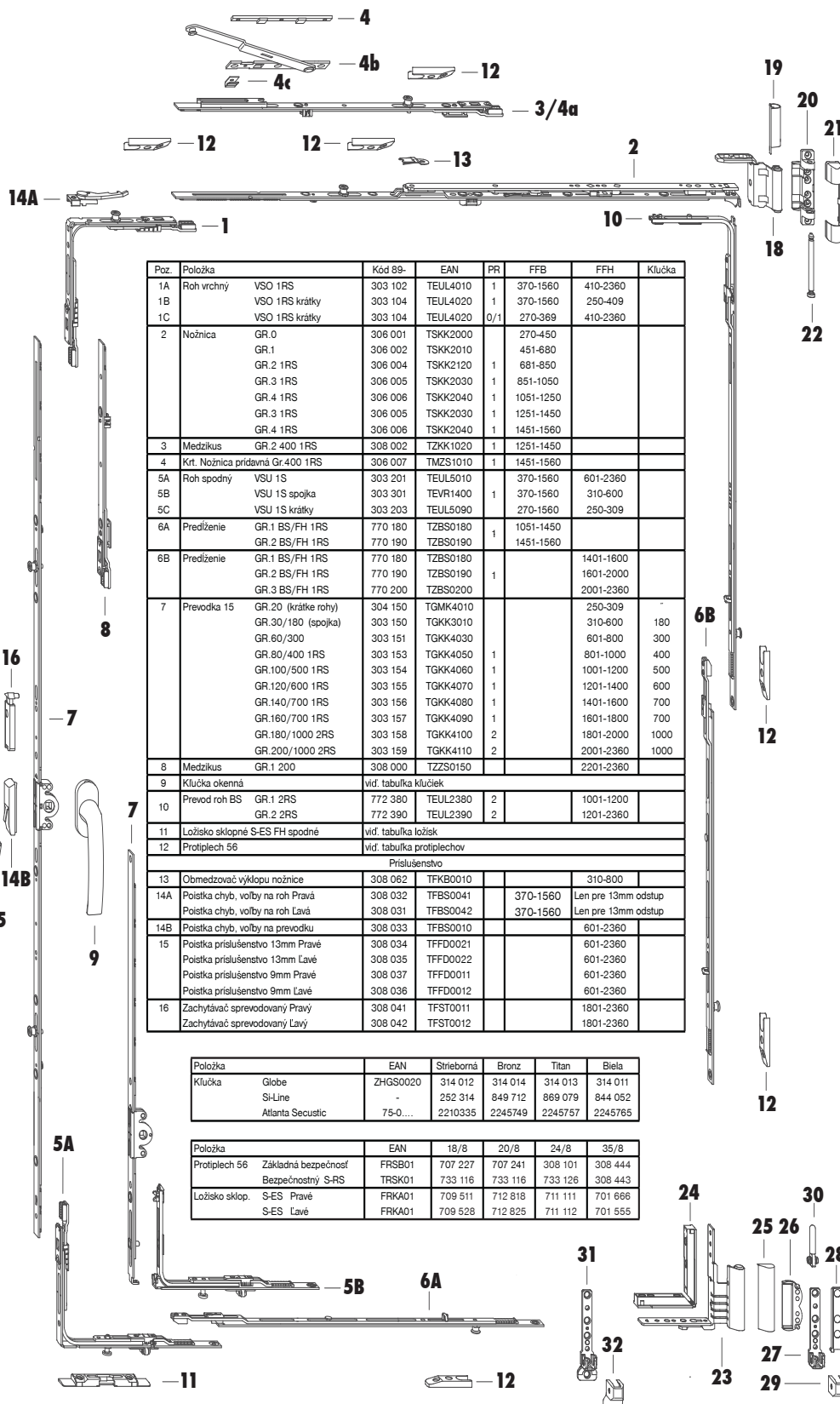
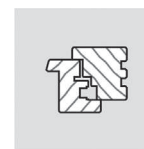
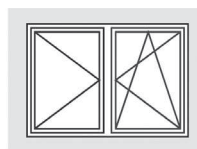
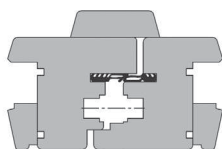

H 12/18-9

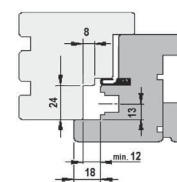

H 12/20-9

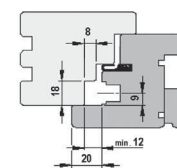

H 12/18-13

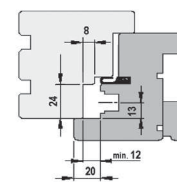

H 12/20-13

| Poz. | Položka                          | Kód 89-                   | EAN      | PR  | FFB       | FFH                 | Kľučka |
|------|----------------------------------|---------------------------|----------|-----|-----------|---------------------|--------|
| 1A   | Roh vrchný VSO 1RS               | 303 102                   | TEUL4010 | 1   | 370-1560  | 410-2360            |        |
| 1B   | VSO 1RS krátky                   | 303 104                   | TEUL4020 | 1   | 370-1560  | 250-409             |        |
| 1C   | VSO 1RS krátky                   | 303 104                   | TEUL4020 | 0/1 | 270-369   | 410-2360            |        |
| 2    | Nožnica GR.0                     | 306 001                   | TSKK2000 |     | 270-450   |                     |        |
|      | GR.1                             | 306 002                   | TSKK2010 |     | 451-680   |                     |        |
|      | GR.2 1RS                         | 306 004                   | TSKK2120 | 1   | 681-850   |                     |        |
|      | GR.3 1RS                         | 306 005                   | TSKK2030 | 1   | 851-1050  |                     |        |
|      | GR.4 1RS                         | 306 006                   | TSKK2040 | 1   | 1051-1250 |                     |        |
|      | GR.3 1RS                         | 306 005                   | TSKK2030 | 1   | 1251-1450 |                     |        |
|      | GR.4 1RS                         | 306 006                   | TSKK2040 | 1   | 1451-1560 |                     |        |
| 3    | Medzikus GR.2 400 1RS            | 308 002                   | TZKK1020 | 1   | 1251-1450 |                     |        |
| 4    | Krt. Nožnica prídavná Gr.400 1RS | 306 007                   | TMZS1010 | 1   | 1451-1560 |                     |        |
| 5A   | Roh spodný VSU 1S                | 303 201                   | TEUL5010 |     | 370-1560  | 601-2360            |        |
| 5B   | VSU 1S spojka                    | 303 301                   | TEVR1400 | 1   | 370-1560  | 310-600             |        |
| 5C   | VSU 1S krátky                    | 303 203                   | TEUL5090 |     | 270-1560  | 250-309             |        |
| 6A   | Predženie GR.1 BS/FH 1RS         | 770 180                   | TZBS0180 | 1   | 1051-1450 |                     |        |
|      | GR.2 BS/FH 1RS                   | 770 190                   | TZBS0190 |     | 1451-1560 |                     |        |
| 6B   | Predženie GR.1 BS/FH 1RS         | 770 180                   | TZBS0180 |     |           | 1401-1600           |        |
|      | GR.2 BS/FH 1RS                   | 770 190                   | TZBS0190 | 1   |           | 1601-2000           |        |
|      | GR.3 BS/FH 1RS                   | 770 200                   | TZBS0200 |     |           | 2001-2360           |        |
| 7    | Prevodka 15 GR.20 (krátke rohy)  | 304 150                   | TGMK4010 |     |           | 250-309             |        |
|      | GR.30/180 (spojka)               | 303 150                   | TGKK3010 |     |           | 310-600             | 180    |
|      | GR.60/300                        | 303 151                   | TGKK4030 |     |           | 601-800             | 300    |
|      | GR.80/400 1RS                    | 303 153                   | TGKK4050 | 1   |           | 801-1000            | 400    |
|      | GR.100/500 1RS                   | 303 154                   | TGKK4060 | 1   |           | 1001-1200           | 500    |
|      | GR.120/600 1RS                   | 303 155                   | TGKK4070 | 1   |           | 1201-1400           | 600    |
|      | GR.140/700 1RS                   | 303 156                   | TGKK4080 | 1   |           | 1401-1600           | 700    |
|      | GR.160/700 1RS                   | 303 157                   | TGKK4090 | 1   |           | 1601-1800           | 700    |
|      | GR.180/1000 2RS                  | 303 158                   | TGKK4100 | 2   |           | 1801-2000           | 1000   |
|      | GR.200/1000 2RS                  | 303 159                   | TGKK4110 | 2   |           | 2001-2360           | 1000   |
| 8    | Medzikus GR.1 200                | 308 000                   | TZZS0150 |     |           | 2201-2360           |        |
| 9    | Kľučka okenná                    | vid. tabuľka kľučiek      |          |     |           |                     |        |
| 10   | Prevod roh BS GR.1 2RS           | 772 380                   | TEUL2380 | 2   |           | 1001-1200           |        |
|      | GR.2 2RS                         | 772 390                   | TEUL2390 | 2   |           | 1201-2360           |        |
| 11   | Ložisko sklopné S-ES FH spodné   | vid. tabuľka ložísk       |          |     |           |                     |        |
| 12   | Protiplech 56                    | vid. tabuľka protiplechov |          |     |           |                     |        |
|      |                                  | Príslušenstvo             |          |     |           |                     |        |
| 13   | Obmedzovač výklopu nožnice       | 308 062                   | TFKB0010 |     |           | 310-600             |        |
| 14A  | Poistka chyb, voľby na roh Pravá | 308 032                   | TFBS0041 |     | 370-1560  | Len pre 13mm odstup |        |
|      | Poistka chyb, voľby na roh Ľavá  | 308 031                   | TFBS0042 |     | 370-1560  | Len pre 13mm odstup |        |
| 14B  | Poistka chyb, voľby na prevodku  | 308 033                   | TFBS0010 |     |           | 601-2360            |        |
| 15   | Poistka príslušenstvo 13mm Pravé | 308 034                   | TFFD0021 |     |           | 601-2360            |        |
|      | Poistka príslušenstvo 13mm Ľavé  | 308 035                   | TFFD0022 |     |           | 601-2360            |        |
|      | Poistka príslušenstvo 9mm Pravé  | 308 037                   | TFFD0011 |     |           | 601-2360            |        |
|      | Poistka príslušenstvo 9mm Ľavé   | 308 036                   | TFFD0012 |     |           | 601-2360            |        |
| 16   | Zachytávač sprevodovaný Pravý    | 308 041                   | TFST0011 |     |           | 1801-2360           |        |
|      | Zachytávač sprevodovaný Ľavý     | 308 042                   | TFST0012 |     |           | 1801-2360           |        |

| Položka          | EAN      | Strieborná | Bronz   | Titan   | Biela   |
|------------------|----------|------------|---------|---------|---------|
| Kľučka Globe     | ZHGS0020 | 314 012    | 314 014 | 314 013 | 314 011 |
| Si-Line          | -        | 252 314    | 849 712 | 869 079 | 844 052 |
| Atlanta Secustic | 75-0...  | 2210335    | 2245749 | 2245757 | 2245765 |

| Položka                           | EAN    | 18/8    | 20/8    | 24/8    | 35/8    |
|-----------------------------------|--------|---------|---------|---------|---------|
| Protiplech 56 Základná bezpečnosť | FRSB01 | 707 227 | 707 241 | 308 101 | 308 444 |
| Bezpečnostný S-RS                 | TRSK01 | 733 116 | 733 116 | 733 126 | 308 443 |
| Ložisko sklop. S-ES Pravé         | FRKA01 | 709 511 | 712 818 | 711 111 | 701 666 |
| S-ES Ľavé                         | FRKA01 | 709 528 | 712 825 | 711 112 | 701 555 |

**SIEGENIA AUBI**<sup>®</sup>  
SOLUTIONS INSIDE

# TITAN AF

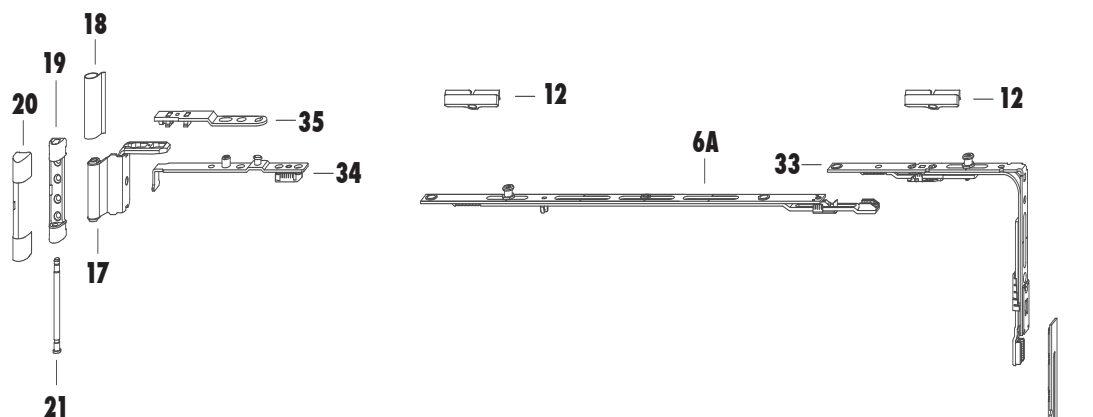
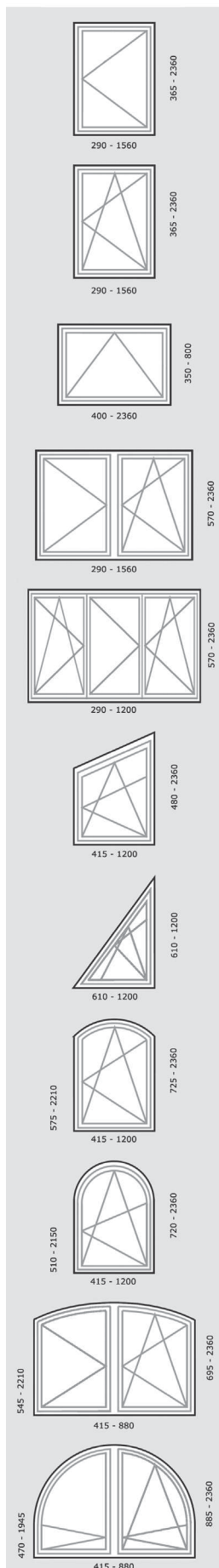
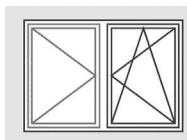

| Poz. | Položka                    | Kód 89- | EAN      | PR | FFB           | FFH       | Kľučka |
|------|----------------------------|---------|----------|----|---------------|-----------|--------|
| 33   | Roh vrchný VSO/K+DF 1RS    | 303 105 | TEUL4110 | 1  | 370-1560      |           |        |
| 34   | Nožnica DF/MN              | 306 021 | TSSD0020 | 0  | 370-1560      |           |        |
| 35   | Nožnica DF                 | 306 023 | TSAD0010 | 0  | 370-1560      |           |        |
| 36   | Prevodka 16 GR.30 (spojka) | 303 160 | TGKS0010 | 0  |               | 410-600   |        |
|      | Štulpová GR.60 (spojka)    | 303 161 | TGKS4030 | 0  |               | 601-800   |        |
|      | GR.80 1SB                  | 304 163 | TGMS4040 | 0  |               | 801-1200  |        |
|      | GR.120 1SB                 | 304 165 | TGMS4070 | 0  |               | 1201-1600 |        |
|      | GR.160 2SB                 | 304 166 | TGMS4060 | 0  |               | 1601-2000 |        |
|      | GR.200 2SB                 | 304 167 | TGMS4080 | 0  |               | 2001-2360 |        |
| 38   | Protiplech GR.140-160      | 308 072 | TRST0100 | 0  |               | 1401-1800 |        |
|      | GR.180-200                 | 308 071 | TRST0010 | 0  |               | 1801-2360 |        |
| 39   | Segment rámu MV GEALAN     | 873 427 | ZRZM01   | 0  |               |           |        |
|      | MV GEALAN 1800 Pa          | 316 924 | ZRZM01   | 0  | Do 1600 - 1ks |           |        |
| 40   | Segment křídla MV+MN       | 700 655 | ZFMV01   | 0  |               | 801-2360  |        |
|      | MV+W+MN 1800 Pa            | 701 655 | ZFMV01   | 0  | Do 2360 - 2ks |           |        |

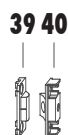

| Poz. | Položka                    | EAN      | Strieborná | Bronz   | Titan   | Biele   |
|------|----------------------------|----------|------------|---------|---------|---------|
| 17   | Záves uhlavý KF 12/20-13   | TBWB6050 |            |         | 307 031 |         |
| 18   | Krytka WKF                 | FKWB0010 | 309 044    | 309 024 | 309 056 | 309 014 |
| 19   | Ložisko nožnic KF D3X3     | TBSL6010 |            |         | 307 061 |         |
|      | KF D6X8                    | TBSL6150 |            |         | 307 042 |         |
| 20   | Krytka S                   | TKSL0020 | 309 045    | 309 025 | 309 055 | 309 015 |
| 21   | Tři nožnicový D6           | TBSB6020 |            |         | 307 071 |         |
| 23   | Ložisko spodné KF D3x3/3   | TBEL6010 |            |         | 307 041 |         |
|      | KF D6x3/8                  | TBEL6140 |            |         | 307 143 |         |
| 24   | Krytka EL O MB             | TKEO0010 | 309 141    | 309 021 | 309 051 | 309 011 |
| 25   | Krytka EL U                | TKEU0010 | 309 142    | 309 022 | 309 052 | 309 012 |
| 27   | Záves spodný EB KF 6x16/20 | TBEB6130 |            |         | 307 051 |         |
|      | KF ADV 6x16/20 s prilakom  | TBEB6150 |            |         | 307 052 |         |
| 28   | Krytka EB                  | FKEB0020 | 309 046    | 309 036 | 309 136 | 309 016 |

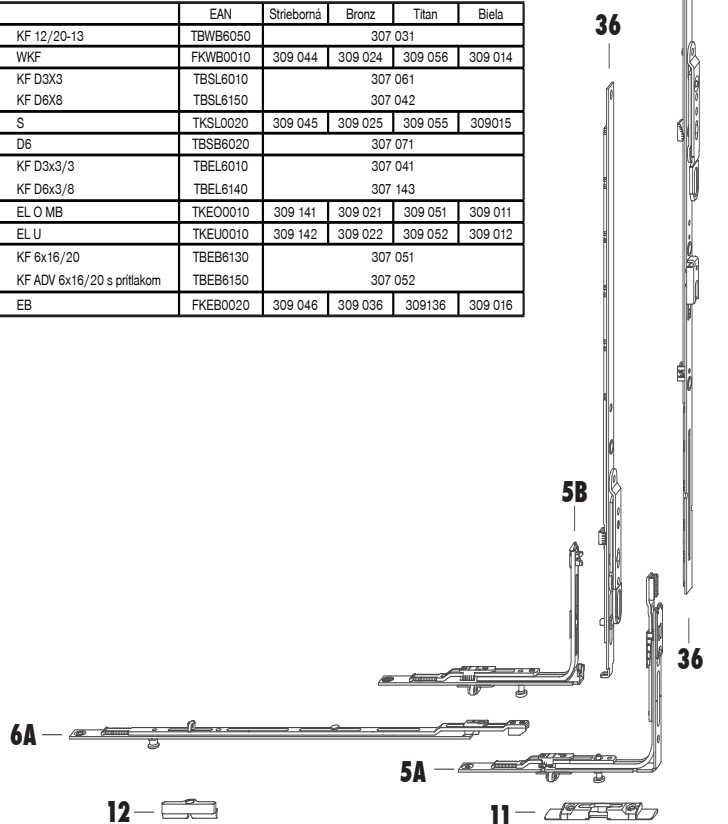
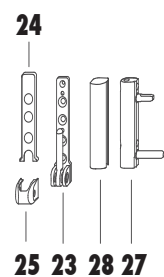

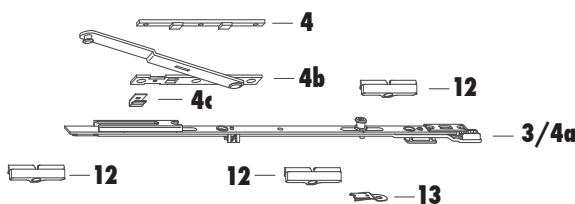
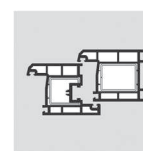
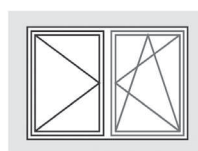

14A



KF 12/20-9



KF 12/20-13

| Poz. | Položka                          | Kód 89-                   | EAN      | PR  | FFB       | FFH                 | Kľučka    |  |
|------|----------------------------------|---------------------------|----------|-----|-----------|---------------------|-----------|--|
| 1A   | Roh vrchný VSO 1RS               | 303 102                   | TEUL4010 | 1   | 370-1560  | 410-2360            |           |  |
| 1B   | VSO 1RS krátky                   | 303 104                   | TEUL4020 | 1   | 370-1560  | 250-409             |           |  |
| 1C   | VSO 1RS krátky                   | 303 104                   | TEUL4020 | 0/1 | 270-369   | 410-2360            |           |  |
| 2    | Nožnica GR.0                     | 306 001                   | TSKK2000 |     | 270-450   |                     |           |  |
|      | GR.1                             | 306 002                   | TSKK2010 |     | 451-680   |                     |           |  |
|      | GR.2 1RS                         | 306 004                   | TSKK2120 | 1   | 681-850   |                     |           |  |
|      | GR.3 1RS                         | 306 005                   | TSKK2030 | 1   | 851-1050  |                     |           |  |
|      | GR.4 1RS                         | 306 006                   | TSKK2040 | 1   | 1051-1250 |                     |           |  |
|      | GR.3 1RS                         | 306 005                   | TSKK2030 | 1   | 1251-1450 |                     |           |  |
|      | GR.4 1RS                         | 306 006                   | TSKK2040 | 1   | 1451-1560 |                     |           |  |
| 3    | Medzikus GR.2 400 1RS            | 308 002                   | TZKK1020 | 1   | 1251-1450 |                     |           |  |
| 4    | Krt. Nožnica prídavná Gr.400 1RS | 306 007                   | TMZS1010 | 1   | 1451-1560 |                     |           |  |
| 5A   | Roh spodný VSU 1S                | 303 201                   | TEUL5010 |     | 370-1560  | 601-2360            |           |  |
| 5B   | VSU 1S spojka                    | 303 301                   | TEVR1400 | 1   | 370-1560  | 310-600             |           |  |
| 5C   | VSU 1S krátky                    | 303 203                   | TEUL5090 |     | 270-1560  | 250-309             |           |  |
| 6A   | Predženie GR.1 BS/FH 1RS         | 770 180                   | TZBS0180 |     | 851-1050  |                     |           |  |
|      | GR.2 BS/FH 1RS                   | 770 190                   | TZBS0190 | 1   | 1051-1450 |                     |           |  |
|      | GR.3 BS/FH 1RS                   | 770 200                   | TZBS0200 |     | 1451-1560 |                     |           |  |
| 6B   | Predženie GR.1 BS/FH 1RS         | 770 180                   | TZBS0180 |     |           | 1401-1600           |           |  |
|      | GR.2 BS/FH 1RS                   | 770 190                   | TZBS0190 | 1   |           | 1601-2000           |           |  |
|      | GR.3 BS/FH 1RS                   | 770 200                   | TZBS0200 |     |           | 2001-2360           |           |  |
| 7    | Prevodka 15 GR.20                | 304 150                   | TGMK4010 |     |           | 250-600             | 125-300   |  |
|      | GR.60                            | 304 151                   | TGMK4020 |     |           | 601-800             | 300-400   |  |
|      | GR.80 1RS                        | 304 153                   | TGMK4040 | 1   |           | 801-1200            | 400-600   |  |
|      | GR.120 1RS                       | 304 155                   | TGMK4070 | 1   |           | 1201-1600           | 600-800   |  |
|      | GR.160 2RS                       | 304 156                   | TGMK4080 | 2   |           | 1601-2000           | 800-1000  |  |
|      | GR.200 2RS                       | 304 157                   | TGMK4080 | 2   |           | 2001-2360           | 1000-1180 |  |
| 9    | Kľučka okenná                    | viď. tabuľka kľúčiek      |          |     |           |                     |           |  |
| 10   | Prevod roh BS GR.1 2RS           | 772 380                   | TEUL2380 | 2   |           | 801-1200            |           |  |
|      | GR.2 2RS                         | 772 390                   | TEUL2390 | 2   |           | 1201-2360           |           |  |
| 11   | Ložisko sklópne S-ES FH spodné   | viď. tabuľka ložísk       |          |     |           |                     |           |  |
| 12   | Protiplech 56                    | viď. tabuľka protiplechov |          |     |           |                     |           |  |
| 13   | Obmedzovač výklopu nožnice       | 308 062                   | TFKB0010 |     |           | 310-800             |           |  |
| 14A  | Poistka chyb, voľby na roh Pravá | 308 032                   | TFBS0041 |     | 370-1560  | Len pre 13mm odstup |           |  |
|      | Poistka chyb, voľby na roh Lavá  | 308 031                   | TFBS0042 |     | 370-1560  | Len pre 13mm odstup |           |  |
| 14B  | Poistka chyb, voľby na prevodku  | 308 033                   | TFBS0010 |     |           | 601-2360            |           |  |
| 15   | Poistka príslušenstvo 13mm Pravé | 308 034                   | TFFD0021 |     |           | 601-2360            |           |  |
|      | Poistka príslušenstvo 13mm Lavé  | 308 035                   | TFFD0022 |     |           | 601-2360            |           |  |
|      | Poistka príslušenstvo 9mm Pravé  | 308 037                   | TFFD0011 |     |           | 601-2360            |           |  |
|      | Poistka príslušenstvo 9mm Lavé   | 308 036                   | TFFD0012 |     |           | 601-2360            |           |  |
| 16   | Zachytávač sprevodovaný Pravý    | 308 041                   | TFST0011 |     |           | 1801-2360           |           |  |
|      | Zachytávač sprevodovaný Lavý     | 308 042                   | TFST0012 |     |           | 1801-2360           |           |  |

| Položka | EAN              | Strieborná | Bronz   | Titan   | Biela   |
|---------|------------------|------------|---------|---------|---------|
| Kľučka  | ZHGS0020         | 314 012    | 314 014 | 314 013 | 314 011 |
|         | Si-Line          | 252 314    | 849 712 | 869 079 | 844 052 |
|         | Atlanta Secustic | 75-0....   | 2210335 | 2245749 | 2245765 |

| Položka        | EAN                 | A4460    | GEALAN  |
|----------------|---------------------|----------|---------|
| Protiplech 56  | Základná bezpečnosť | TRSM0070 | 308 108 |
|                | Zvýšená bezpečnosť  | TRSN0050 | 308 109 |
|                | Bezpečnostný S-RS   | TRSK0590 | 308 106 |
| Ložisko sklóp. | S-ES                | FRKA0200 | 328 477 |

5A

5C

6A

11

12

24

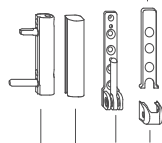

27 28 23 25

**SIEGENIA AUBI**<sup>®</sup>  
SOLUTIONS INSIDE

**PSK PORTAL 160<sup>PLUS</sup> (130<sup>PLUS</sup>, 100<sup>PLUS</sup>)**

 maximálne  
zaťaženie **160 kg**

Schéma A



šírka krídla 670 - 1600 mm

výška krídla 840 - 2360 mm

Schéma G

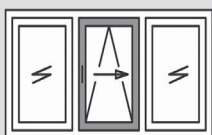

šírka krídla 670 - 1600 mm

výška krídla 840 - 2360 mm

Schéma C1

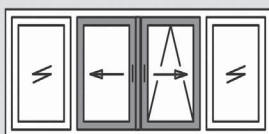

šírka krídla 670 - 1600 mm

výška krídla 840 - 2360 mm

Schéma C2

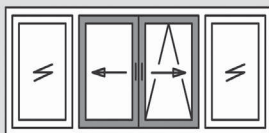

šírka krídla 670 - 1600 mm

výška krídla 1000 - 2360 mm

Schéma K



šírka krídla 670 - 1600 mm

výška krídla 840 - 2360 mm

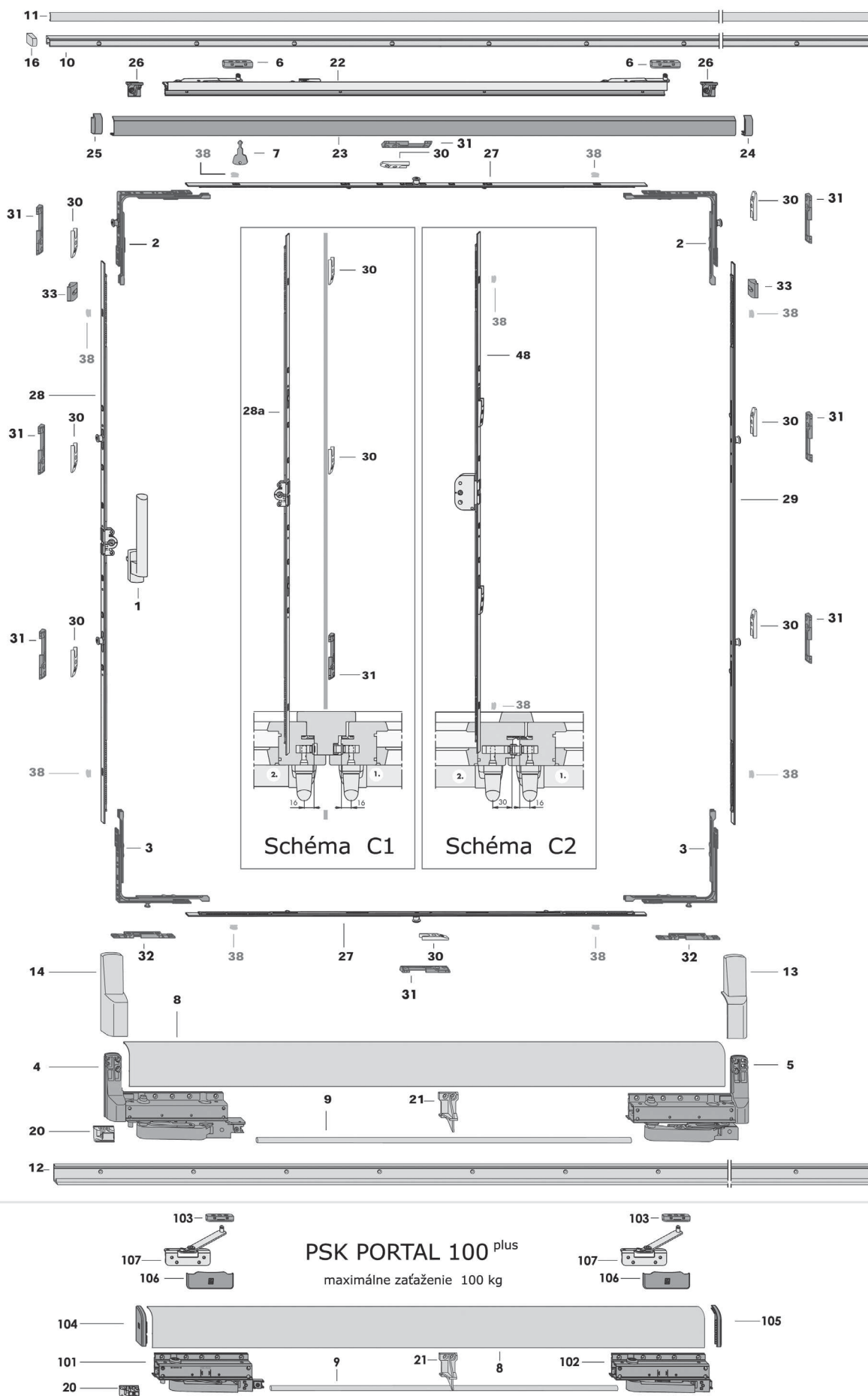



| Poz. | Položka           | Farba  | obj. číslo  | počet ks v schéme |   |    |    |   |
|------|-------------------|--|---|-------------------|---|----|----|---|
|      |                   |  |   | A                 | G | C1 | C2 | K |
| 1    | Kľučka Si-Line HS | Biela RAL 9016<br>Hnedá RAL 8022<br>Strieborná EV1<br>Titan Matný svetlý<br>Bronz tmavý C 33 | 89-875926<br>89-895689<br>89-875902<br>89-884744<br>89-875940 | 1                 | 1 | 2  | 2  | 2 |

| Poz. | Položka            | obj. číslo      |                     |            |                 | počet ks v schéme |           |    |    |   |
|------|--------------------|-----------------|---------------------|------------|-----------------|-------------------|-----------|----|----|---|
|      |                    | Biela           | Hnedá               | Strieborná | Bronz           | A                 | G         | C1 | C2 | K |
| 2    | Prevod roh VS IRS  | 89-716618       |                     |            |                 | 2                 | 2         | 4  | 4  | 4 |
| 3    | Prevod roh VS S-ES | FEUL0250-100040 |                     |            |                 | 2                 | 2         | 4  | 4  | 4 |
| 4-7  | Vozík PSK PLUS     | pravý           | 2/0                 | 2/4        | 89-003110       | 1                 | 1         | 2  | 2  | 2 |
|      |                    | ľavý            | 2/0                 | 2/4        | 89-003210       |                   |           |    |    |   |
| 8-21 | Profil PSK PLUS    | veľkosť         | dĺžka               | predčísle  | PMPJ01xx-xxxxxx |                   |           |    |    |   |
|      |                    | 87/200          | 670-870 do 2000     | 00-502010  | 00-512010       | 00-525010         | 00-531010 | 1  | 1  | 2 |
|      |                    | 107/240         | 871-1070 2001-2400  | 10-502010  | 10-512010       | 10-525010         | 10-531010 |    |    |   |
|      |                    | 130/286         | 1071-1300 2401-2860 | 20-502010  | 20-512010       | 20-525010         | 30-521010 |    |    |   |
|      |                    | 160/346         | 1301-1600 2861-3460 | 30-502010  | 30-512010       | 30-525010         | 30-531010 |    |    |   |

|       |                 |         |           |      |           |           |           |                 |   |   |
|-------|-----------------|---------|-----------|------|-----------|-----------|-----------|-----------------|---|---|
| 22    | Nožnice PSK 160 | veľkosť | dĺžka     |      |           |           |           |                 |   |   |
|       |                 | 87      | 670-870   | 620  |           |           |           | 89-716526       |   |   |
|       |                 | 107     | 871-1070  | 820  |           |           |           | 89-716533       | 1 | 1 |
|       |                 | 130     | 1071-1300 | 1020 |           |           |           | 89-716540       |   |   |
|       |                 | 160     | 1301-1600 | 1220 |           |           |           | 89-716557       |   |   |
| 23-26 | Profil PSK PLUS | veľkosť | dĺžka     |      |           |           |           |                 |   |   |
|       |                 | 87      | 670-870   |      | 89-305850 | 89-305874 | 89-305843 | 89-305867       | 1 | 1 |
|       |                 | 107     | 871-1070  |      | 89-305898 | 89-305911 | 89-305881 | 89-305904       |   |   |
|       |                 | 130     | 1071-1300 |      | 89-305935 | 89-305959 | 89-305928 | 89-305942       |   |   |
|       |                 | 160     | 1301-1600 |      | 89-305973 | 89-305997 | 89-305966 | 89-305980       |   |   |
| 27    | Medzikus RS     | veľkosť | dĺžka     |      |           |           |           |                 |   |   |
|       |                 | 1       | 670-870   | -    | -         | -         | -         | 89-703816       |   |   |
|       |                 | 1 MV    | 871-1070  | 1    | (1)       |           |           | FZZZ0020-100040 | 2 | 2 |
|       |                 | 2 MV    | 1071-1300 | 1    | (1)       |           |           | FZZZ0030-100040 |   |   |
|       |                 | 3 MV    | 1301-1600 | 1    | (1)       |           |           | FZZZ0040-100040 |   |   |

|    |               |         |           |          |   |     |  |                 |   |   |
|----|---------------|---------|-----------|----------|---|-----|--|-----------------|---|---|
| 28 | Prevodka 3 RS | veľkosť | dĺžka     |          |   |     |  |                 |   |   |
|    |               | 1       | 840-1100  | 420-550  | - | -   |  | 89-706992       |   |   |
|    |               | 1A      | 840-1180  | 420-590  | 1 | (1) |  | FGMK3110-100040 |   |   |
|    |               | 2       | 1000-1460 | 500-730  | 1 | (1) |  | FGMK3120-100040 | 1 | 1 |
|    |               | 3       | 1461-1920 | 730-960  | 2 | (2) |  | FGMK3130-100040 |   |   |
|    |               | 4/TL    | 1880-2360 | 940-1180 | 2 | (2) |  | FGMK3140-100040 |   |   |
|    |               | 4A/TL   | 1650-2150 | 940-1180 | 2 | (2) |  | FGMK3150-100040 |   |   |
| 29 | Medzikus RS   | veľkosť | dĺžka     |          |   |     |  |                 |   |   |
|    |               | 1       | 840-1100  |          | - | -   |  | 89-703816       |   |   |
|    |               | 1A      | 840-1100  |          | 1 | (1) |  | FZZZ0020-100040 |   |   |
|    |               | 2       | 1000-1460 |          | 1 | (1) |  | FZZZ0030-100040 | 1 | 1 |
|    |               | 3       | 1461-1920 |          | 1 | (1) |  | FZZZ0040-100040 |   |   |
|    |               | 4/TL    | 1880-2360 |          | 2 | (2) |  | FZZZ0050-100020 |   |   |
|    |               | 4A/TL   | 1650-2150 |          | 2 | (2) |  | FZZZ0060-100020 |   |   |

| Eurofalc |                      |       |  | 18/8            | 20/8            | 24/8            |
|----------|----------------------|-------|--|-----------------|-----------------|-----------------|
|          |                      |       |  | A1361           | A1362           | A4500           |
| 30       | Protiplech 56        | pravý |  | 89-707227       | 89-707241       | 89-725672       |
|          |                      | ľavý  |  |                 |                 | 89-725689       |
| 31       | Protiplech S-RS      | pravý |  | TRSK0431-100060 | TRSK0441-100060 | TRSK0381-100060 |
|          |                      | ľavý  |  | TRSK0432-100060 | TRSK0442-100060 | TRSK0382-100060 |
| 32       | Sklopné ložisko S-ES | pravé |  | 89-709511       | 89-712818       | 89-711111       |
|          |                      | ľavé  |  | 89-709528       | 89-712825       | 89-711112       |
| 33       | Nábeh vymedzovací    |       |  | 89-301401       |                 |                 |

|     |                              |         |           |          |  |  |  |                 |  |  |
|-----|------------------------------|---------|-----------|----------|--|--|--|-----------------|--|--|
| 28a | Prevodka 3 (bez čapov)       | veľkosť | dĺžka     |          |  |  |  |                 |  |  |
|     |                              | 1A      | 840-1180  | 420-590  |  |  |  | 89-716823       |  |  |
|     |                              | 2       | 1000-1460 | 500-730  |  |  |  | 89-716786       |  |  |
|     |                              | 3       | 1461-1920 | 730-960  |  |  |  | 89-707906       |  |  |
|     |                              | 4/TL    | 1880-2360 | 940-1180 |  |  |  | 89-707913       |  |  |
| 28a | Prevodka 3/30-M5°C" (DRM 30) | veľkosť | dĺžka     |          |  |  |  |                 |  |  |
|     |                              | 2       | 1000-1460 | 500-730  |  |  |  | 89-712481       |  |  |
|     |                              | 3       | 1461-1920 | 730-960  |  |  |  | PGVE0010-100010 |  |  |
|     |                              | 4/TL    | 1880-2360 | 940-1180 |  |  |  | 89-712504       |  |  |
|     |                              | 4A/TL   | 1650-2150 | 940-1180 |  |  |  | 89-712597       |  |  |

19 18 17



|         |                      |       |     |     |           |           |           |                           |   |   |   |   |   |
|---------|----------------------|-------|-----|-----|-----------|-----------|-----------|---------------------------|---|---|---|---|---|
| 101-103 | Vozík PSK 100 PLUS   | pravý | 2/0 | 2/4 |           |           |           | PMKJ0051-100010           | 1 | 1 | 2 | 2 | 2 |
|         |                      | ľavý  | 2/0 | 2/4 |           |           |           | PMKJ0052-100010           |   |   |   |   |   |
| 104-106 | Krytky PSK 100 PLUS  |       |     |     |           |           |           | predčísle PMAJ00xx-xxxxxx | 1 | 1 | 2 | 2 | 2 |
|         |                      |       |     |     | 30-004010 | 30-012010 | 30-024010 |                           |   |   |   |   |   |
| 107     | Nožnice PSK 100 PLUS |       |     |     |           |           |           | PSKJ0050-100110           | 1 | 1 | 2 | 2 | 2 |

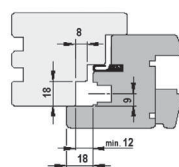

H 12/18-9

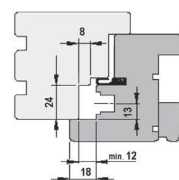

H 12/20-9

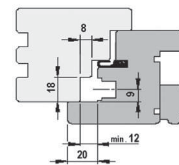

H 12/18-13

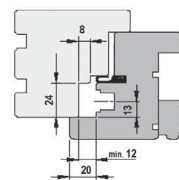

H 12/20-13

**SIEGENIA AUBI**<sup>®</sup>  
SOLUTIONS INSIDE

**PSK PORTAL 160 PLUS (130 PLUS, 100 PLUS)**

 maximálne  
zaťaženie **160 kg**

Schéma A

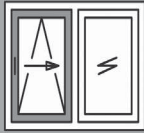

šírka krídla 670 - 1600 mm

výška krídla 840 - 2360 mm

Schéma G

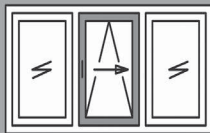

šírka krídla 670 - 1600 mm

výška krídla 840 - 2360 mm

Schéma C1

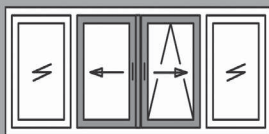

šírka krídla 670 - 1600 mm

výška krídla 840 - 2360 mm

Schéma C2

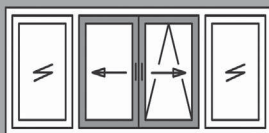

šírka krídla 670 - 1600 mm

výška krídla 1000 - 2360 mm

Schéma K



šírka krídla 670 - 1600 mm

výška krídla 840 - 2360 mm

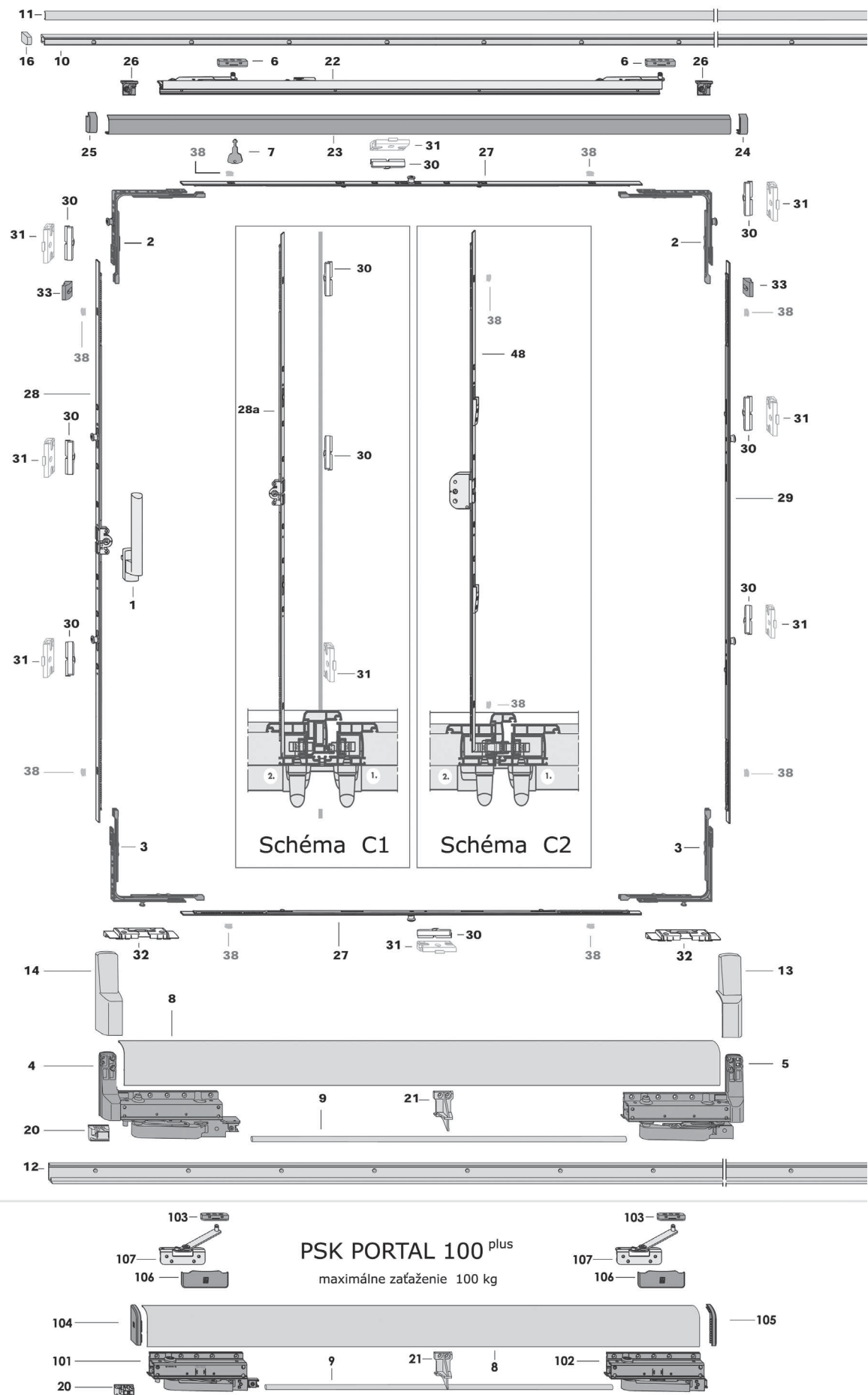

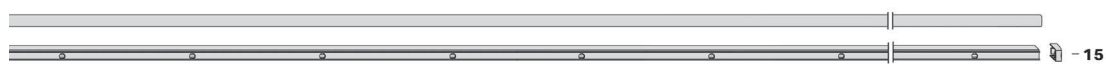
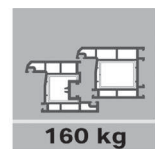

| Poz. | Položka           | Farba              | obj. číslo | počet ks v schéme |   |    |    |   |
|------|-------------------|--------------------|------------|-------------------|---|----|----|---|
|      |                   |                    |            | A                 | G | C1 | C2 | K |
| 1    | Kľučka Si-Line HS | Biela RAL 9016     | 89-875926  |                   |   |    |    |   |
|      |                   | Hnedá RAL 8022     | 89-895689  |                   |   |    |    |   |
|      |                   | Strieborná EV1     | 89-875902  | 1                 | 1 | 2  | 2  | 2 |
|      |                   | Titan Matný svetlý | 89-884744  |                   |   |    |    |   |
|      |                   | Bronz tmavý C 33   | 89-875940  |                   |   |    |    |   |

| Poz. | Položka            | obj. číslo      |                     |            |                           | počet ks v schéme |           |           |    |   |   |   |
|------|--------------------|-----------------|---------------------|------------|---------------------------|-------------------|-----------|-----------|----|---|---|---|
|      |                    | Biela           | Hnedá               | Strieborná | Bronz                     | A                 | G         | C1        | C2 | K |   |   |
| 2    | Prevod roh VS IRS  | 89-716618       |                     |            |                           | 2                 | 2         | 4         | 4  | 4 |   |   |
| 3    | Prevod roh VS S-ES | FEUL0250-100040 |                     |            |                           | 2                 | 2         | 4         | 4  | 4 |   |   |
| 4-7  | Vozík PSK PLUS     | pravý           | 2/0                 | 2/4        | 89-003110                 | 1                 | 1         | 2         | 2  | 2 |   |   |
|      |                    | ľavý            | 2/0                 | 2/4        | 89-003210                 |                   |           |           |    |   |   |   |
| 8-21 | Profil PSK PLUS    | veľkosť         | dĺžka               |            | predčísle PMPJ01xx-xxxxxx |                   |           |           |    |   |   |   |
|      |                    | 87/200          | 670-870 do 2000     |            | 00-502010                 | 00-512010         | 00-525010 | 00-531010 | 1  | 1 | 2 | 2 |
|      |                    | 107/240         | 871-1070 2001-2400  |            | 10-502010                 | 10-512010         | 10-525010 | 10-531010 |    |   |   |   |
|      |                    | 130/286         | 1071-1300 2401-2860 |            | 20-502010                 | 20-512010         | 20-525010 | 30-521010 |    |   |   |   |
|      |                    | 160/346         | 1301-1600 2861-3460 |            | 30-502010                 | 30-512010         | 30-525010 | 30-531010 |    |   |   |   |

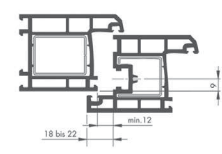

KF 12/20-9

|    |                 |         |           |      |  |           |   |   |   |   |
|----|-----------------|---------|-----------|------|--|-----------|---|---|---|---|
| 22 | Nožnice PSK 160 | veľkosť | dĺžka     |      |  |           |   |   |   |   |
|    |                 | 87      | 670-870   | 620  |  | 89-716526 | 1 | 1 | 2 | 2 |
|    |                 | 107     | 871-1070  | 820  |  | 89-716533 |   |   |   |   |
|    |                 | 130     | 1071-1300 | 1020 |  | 89-716540 |   |   |   |   |
|    |                 | 160     | 1301-1600 | 1220 |  | 89-716557 |   |   |   |   |

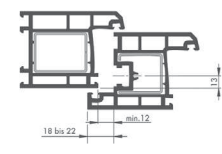

KF 12/20-13

|    |               |         |           |          |   |     |                 |   |   |   |   |
|----|---------------|---------|-----------|----------|---|-----|-----------------|---|---|---|---|
| 28 | Prevodka 3 RS | veľkosť | dĺžka     |          |   |     |                 |   |   |   |   |
|    |               | 1       | 840-1100  | 420-550  | - | -   | 89-706992       | 1 | 1 | 1 | 2 |
|    |               | 1A      | 840-1180  | 420-590  | 1 | (1) | FGMK3110-100040 |   |   |   |   |
|    |               | 2       | 1000-1460 | 500-730  | 1 | (1) | FGMK3120-100040 |   |   |   |   |
|    |               | 3       | 1461-1920 | 730-960  | 2 | (2) | FGMK3130-100040 |   |   |   |   |
|    |               | 4/TL    | 1880-2360 | 940-1180 | 2 | (2) | FGMK3140-100040 |   |   |   |   |

| Poz. | Profil               | GEALAN |           | SALAMANDER |          | Pr. data list |        |
|------|----------------------|--------|-----------|------------|----------|---------------|--------|
|      |                      | A1940  | A2860     | A2860      | A2860    | A.....        | A..... |
| 30   | Protiplech 56        | pravý  | 89-712269 | 89-712290  | 89-..... |               |        |
| 31   | Protiplech S-ES      | pravý  | 89-703687 | 89-704967  | 89-..... |               |        |
| 32   | Sklopné ložisko S-ES | pravé  | 89-328477 | 89-705803  | 89-..... |               |        |
| 33   | Nábeh vymedzovací    | ľavé   | 89-301234 | 89-301333  | 89-..... |               |        |

|     |                        |         |           |          |  |           |   |   |   |   |
|-----|------------------------|---------|-----------|----------|--|-----------|---|---|---|---|
| 28a | Prevodka 3 (bez čapov) | veľkosť | dĺžka     |          |  |           |   |   |   |   |
|     |                        | 1A      | 840-1180  | 420-590  |  | 89-716823 | - | - | 1 | - |
|     |                        | 2       | 1000-1460 | 500-730  |  | 89-716786 |   |   |   |   |
|     |                        | 3       | 1461-1920 | 730-960  |  | 89-707906 |   |   |   |   |
|     |                        | 4/TL    | 1880-2360 | 940-1180 |  | 89-707913 |   |   |   |   |

|     |                              |         |           |          |  |                 |   |   |   |   |   |
|-----|------------------------------|---------|-----------|----------|--|-----------------|---|---|---|---|---|
| 28a | Prevodka 3/30-M5°C" (DRM 30) | veľkosť | dĺžka     |          |  |                 |   |   |   |   |   |
|     |                              | 2       | 1000-1460 | 500-730  |  | 89-712481       | - | - | - | 1 | - |
|     |                              | 3       | 1461-1920 | 730-960  |  | PGVE0010-100010 |   |   |   |   |   |
|     |                              | 4/TL    | 1880-2360 | 940-1180 |  | 89-712504       |   |   |   |   |   |
|     |                              | 4A/TL   | 1650-2150 | 940-1180 |  | 89-712597       |   |   |   |   |   |

19 18 17



|         |                      |       |     |     |                           |   |   |   |   |   |
|---------|----------------------|-------|-----|-----|---------------------------|---|---|---|---|---|
| 101-103 | Vozík PSK 100 PLUS   | pravý | 2/0 | 2/4 | PMKJ0051-100010           | 1 | 1 | 2 | 2 | 2 |
|         |                      | ľavý  | 2/0 | 2/4 | PMKJ0052-100010           |   |   |   |   |   |
| 104-106 | Krytky PSK 100 PLUS  |       |     |     | predčísle PMAJ00xx-xxxxxx | 1 | 1 | 2 | 2 | 2 |
|         |                      |       |     |     | 30-004010                 |   |   |   |   |   |
| 107     | Nožnice PSK 100 PLUS |       |     |     | PSKJ0050-100110           | 1 | 1 | 2 | 2 | 2 |

**SIEGENIA AUBI**  
SOLUTIONS INSIDE

**PSK PORTAL 200-Z PLUS (PS 160-Z PLUS)**

 maximálne  
zaťaženie **200 kg**

Schéma A



 šírka krídla 770 - 2000 mm  
výška krídla 1000 - 2360 mm

Schéma G

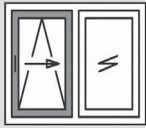

 šírka krídla 770 - 2000 mm  
výška krídla 1000 - 2360 mm

Schéma C1

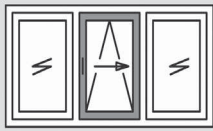

 šírka krídla 770 - 2000 mm  
výška krídla 1000 - 2360 mm

Schéma C2b

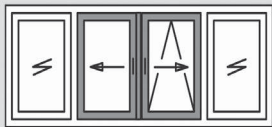

 šírka krídla 770 - 2000 mm  
výška krídla 1460 - 2360 mm

Schéma K

 šírka krídla 770 - 2000 mm  
výška krídla 1000 - 2360 mm



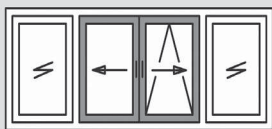
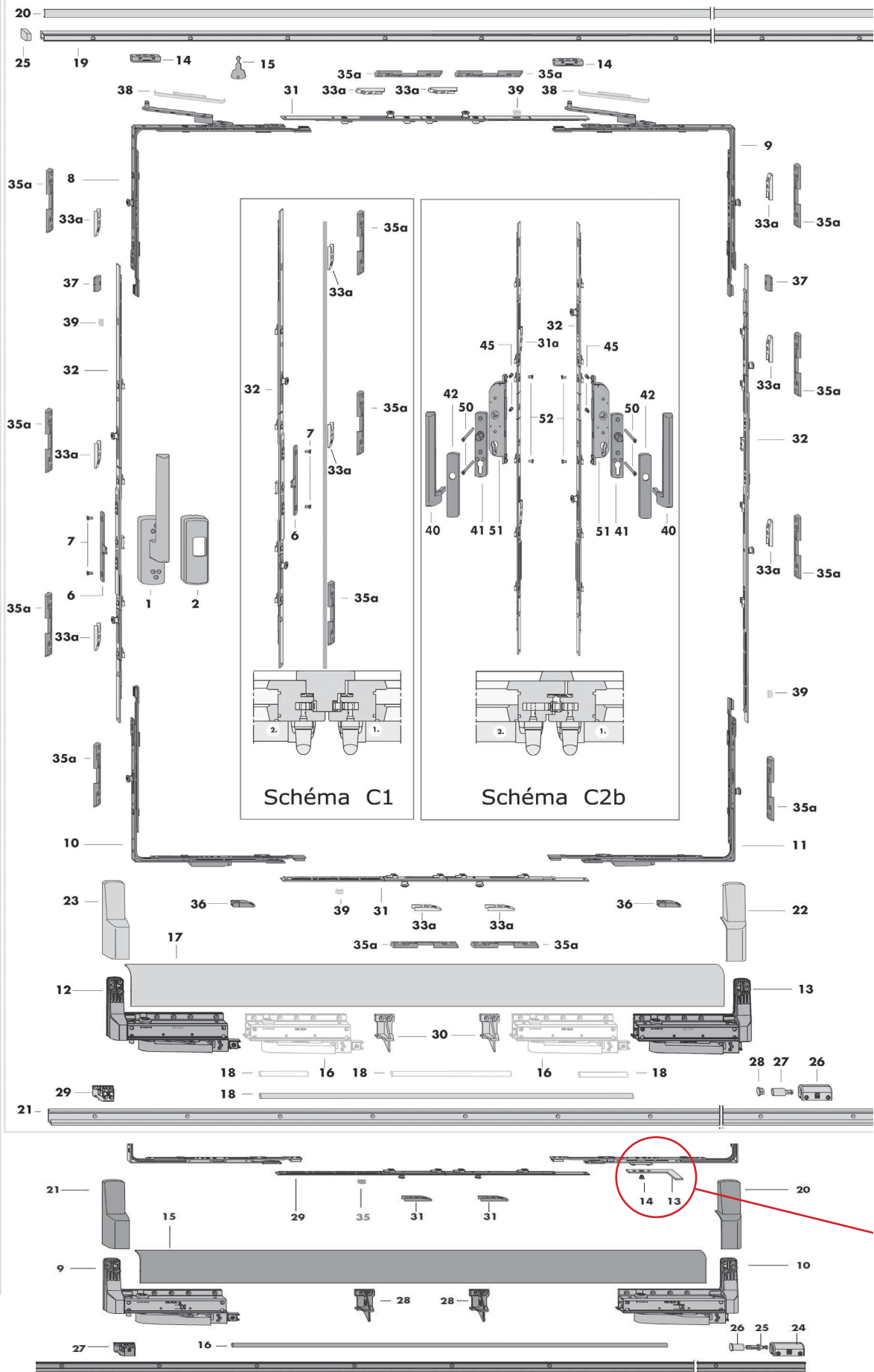

| Poz. | Položka          | Farba            | obj. číslo |           | počet ks v schéme |   |    |    |   |
|------|------------------|------------------|------------|-----------|-------------------|---|----|----|---|
|      |                  |                  | ľavá       | pravá     | A                 | G | C1 | C2 | K |
| 1-2  | Kľučka PSK200/GH | Biela RAL 9016   | 89-296325  | 89-296271 | 1                 | 1 | 1  | -  | 1 |
|      |                  | Hnedá RAL 8022   | 89-297803  | 89-297797 |                   |   |    |    |   |
|      |                  | Strieborná EV1   | 89-296301  | 89-296257 |                   |   |    |    |   |
|      |                  | Bronz tmavý C 33 | 89-296349  | 89-296295 |                   |   |    |    |   |

| Poz.  | Položka                   | obj. číslo | počet ks v schéme   |           |            |           |           |      |      |    |   |   |
|-------|---------------------------|------------|---------------------|-----------|------------|-----------|-----------|------|------|----|---|---|
|       |                           |            | Biela               | Hnedá     | Strieborná | Bronz     | A         | G    | C1   | C2 | K |   |
| 6-11  | Prevod roh PSK 200-Z S-RS | pravý      | 9 mm                | 2/0       | 2/4        | 1         | 1         | 0..1 | 0..1 | 1  |   |   |
|       |                           |            | 13 mm               | 2/0       | 2/4        |           |           |      |      |    |   |   |
|       |                           | ľavý       | 9 mm                | 2/0       | 2/4        |           |           |      |      |    |   |   |
|       |                           |            | 13 mm               | 2/0       | 2/4        |           |           |      |      |    |   |   |
| 12-15 | Vozík PSK PLUS            | pravý      | 2/0                 | 2/4       | 1          | 1         | 1         | 1    | 1    |    |   |   |
| ľavý  | 2/0                       | 2/4        |                     |           |            |           |           |      |      |    |   |   |
| 17-30 | Profil PSK PLUS           | veľkosť    | dĺžka               | 00-502010 | 00-512010  | 00-525010 | 00-531010 | 1    | 1    | 2  | 2 | 2 |
|       |                           |            |                     |           |            |           |           |      |      |    |   |   |
|       |                           | 107/240    | 871-1070 2001-2400  |           |            |           |           |      |      |    |   |   |
|       |                           | 130/286    | 1071-1300 2401-2860 |           |            |           |           |      |      |    |   |   |
|       |                           | 160/346    | 1301-1600 2861-3460 | 30-502010 | 30-512010  | 30-525010 | 30-531010 |      |      |    |   |   |

|    |               |         |           |     |     |                            |           |           |           |           |   |     |           |   |
|----|---------------|---------|-----------|-----|-----|----------------------------|-----------|-----------|-----------|-----------|---|-----|-----------|---|
| 31 | Medzikus S-RS | veľkosť | dĺžka     | 1/0 | 0/1 | 89-713303                  | 2         | 2         | 4         | 4         | 4 |     |           |   |
|    |               |         |           |     |     |                            |           |           |           |           |   | 100 | 770-1000  |   |
|    |               | 123     | 1001-1230 |     |     |                            |           |           |           |           |   |     |           |   |
|    |               | 146     | 1231-1460 |     |     |                            |           |           |           |           |   |     |           |   |
|    |               | 169     | 1461-1690 |     |     |                            |           |           |           |           |   |     |           |   |
| 32 | Prevodka OS   | veľkosť | dĺžka     | 1/0 | 0/1 | 89-713303                  | 2         | 2         | 4         | 4         | 4 |     |           |   |
|    |               |         |           |     |     |                            |           |           |           |           |   | 123 | 1000-1230 |   |
|    |               | 146     | 1231-1460 |     |     |                            |           |           |           |           |   |     |           |   |
|    |               | 169     | 1461-1690 |     |     |                            |           |           |           |           |   |     |           |   |
|    |               | 192     | 1691-1920 |     |     |                            |           |           |           |           |   |     |           |   |
| 38 | Krytka S      | veľkosť | dĺžka     | 2/0 | 0/2 | predčíslie PKAL00xx-xxxxxx | 10-002010 | 10-012010 | 10-025010 | 10-030010 | 2 | 2   | 4         | 4 |
|    |               |         |           |     |     |                            |           |           |           |           |   |     |           |   |
|    |               | 215     | 1921-2000 |     |     |                            |           |           |           |           |   |     |           |   |
|    |               | 238     | 2150-2360 |     |     |                            |           |           |           |           |   |     |           |   |
|    |               | 215     | 1921-2000 |     |     |                            |           |           |           |           |   |     |           |   |

|       |                           | Eurofalc |  | 18/8            | 20/8            | 24/8            |
|-------|---------------------------|----------|--|-----------------|-----------------|-----------------|
| 33a   | Protiplech 56             | pravý    |  | A1361           | A1362           | A4500           |
|       |                           | ľavý     |  | 89-707227       | 89-707241       | 89-725672       |
| 35a   | Protiplech S-RS PSK 200-Z |          |  | PRTL0090-100010 | PRTL0100-100010 | PRTL0100-100010 |
| 36-37 | Rámový segment PSK 200    | pravé    |  | 89-715017       | 89-715024       | 89-715024       |
|       |                           | ľavé     |  |                 | 89-715031       | 89-715031       |

|     |                                      |         |           |     |                 |      |      |      |      |
|-----|--------------------------------------|---------|-----------|-----|-----------------|------|------|------|------|
| 31a | Prevodka (s protiplechmi)            | veľkosť | dĺžka     | 690 | PZKL0250-100010 |      |      |      |      |
|     |                                      |         |           |     |                 |      |      |      |      |
|     |                                      | 192     | 1691-1920 |     |                 |      |      |      |      |
|     |                                      | 215     | 1921-2150 |     |                 |      |      |      |      |
|     |                                      | 238     | 2151-2360 |     |                 |      |      |      |      |
| 31a | Prevodka S-RS (s protiplechmi)       | veľkosť | dĺžka     | 690 | PZKL0350-100010 |      |      |      | 1    |
|     |                                      |         |           |     |                 |      |      |      |      |
|     |                                      | 192     | 1691-1920 |     |                 |      |      |      |      |
|     |                                      | 215     | 1921-2150 |     |                 |      |      |      |      |
|     |                                      | 238     | 2151-2360 |     |                 |      |      |      |      |
| 16  | Vozík prídavný PSK PLUS (nad 160 kg) | pravý   |           |     | PMWL0031-100110 | 0..1 | 0..1 | 0..1 | 0..1 |
|     |                                      | ľavý    |           |     | PMWL0032-100110 | 0..1 | 0..1 | 0..1 | 0..1 |

|          |                           |       |            |           |           |                 |   |   |   |           |                 |                 |
|----------|---------------------------|-------|------------|-----------|-----------|-----------------|---|---|---|-----------|-----------------|-----------------|
| 40-42    | Kľučka SI-Line HS         | Farba | Kľučka     | Krytka    | Madlo     | -               | - | 2 | - |           |                 |                 |
|          |                           |       | 89-329689  | 89-876572 | 89-273340 |                 |   |   |   |           |                 |                 |
|          |                           |       | Strieborná | 89-524014 | 89-876558 |                 |   |   |   | 89-880838 |                 |                 |
|          |                           |       | Bronz C 33 | 89-301074 | 89-876596 |                 |   |   |   | 89-880883 |                 |                 |
| 45       | Matica fixačného valčeka  |       | 89-800287  |           |           | -               | - | 4 | - |           |                 |                 |
| 51-52    | Prevodový set PSK 200-Z   | PZ-30 | DRM 30 mm  |           | 89-716335 |                 |   | - | 2 |           |                 |                 |
|          |                           | PZ-40 | DRM 40 mm  |           | 89-716342 |                 |   | - | 2 |           |                 |                 |
| 6a - 11a | Prevod roh PSK 200-Z S-RS | pravý | 9 mm       | 2/0       | 2/4       | PMEL0061-100010 | - | - | 1 | 1         |                 |                 |
|          |                           |       | 13 mm      | 2/0       | 2/4       | PMEL0051-100010 |   |   |   |           |                 |                 |
|          |                           |       | schéma C   | ľavý      | 9 mm      | 2/0             |   |   |   |           | 2/4             | PMEL0062-100010 |
|          |                           |       |            | 13 mm     | 2/0       | 2/4             |   |   |   |           | PMEL0052-100010 |                 |



H 12/18-9

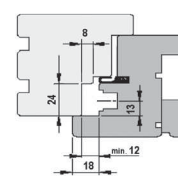

H 12/20-9

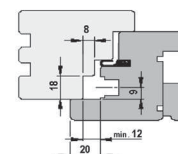

H 12/18-13

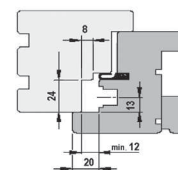

H 12/20-13

Segment určujúci rozdiel medzi PSK 200-Z a PS 160-Z

**SIEGENIA AUBI**<sup>®</sup>  
SOLUTIONS INSIDE

**PSK PORTAL 200-Z<sup>PLUS</sup>**

 maximálne  
zaťaženie **200 kg**

Schéma A



 šírka krídla 770 - 2000 mm  
výška krídla 1000 - 2360 mm

Schéma G

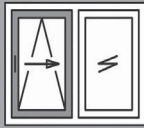

 šírka krídla 770 - 2000 mm  
výška krídla 1000 - 2360 mm

Schéma C1

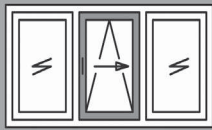

 šírka krídla 770 - 2000 mm  
výška krídla 1000 - 2360 mm

Schéma C2b

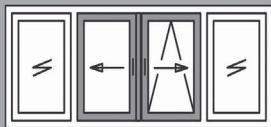

 šírka krídla 770 - 2000 mm  
výška krídla 1460 - 2360 mm

Schéma K

 šírka krídla 770 - 2000 mm  
výška krídla 1000 - 2360 mm

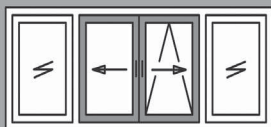
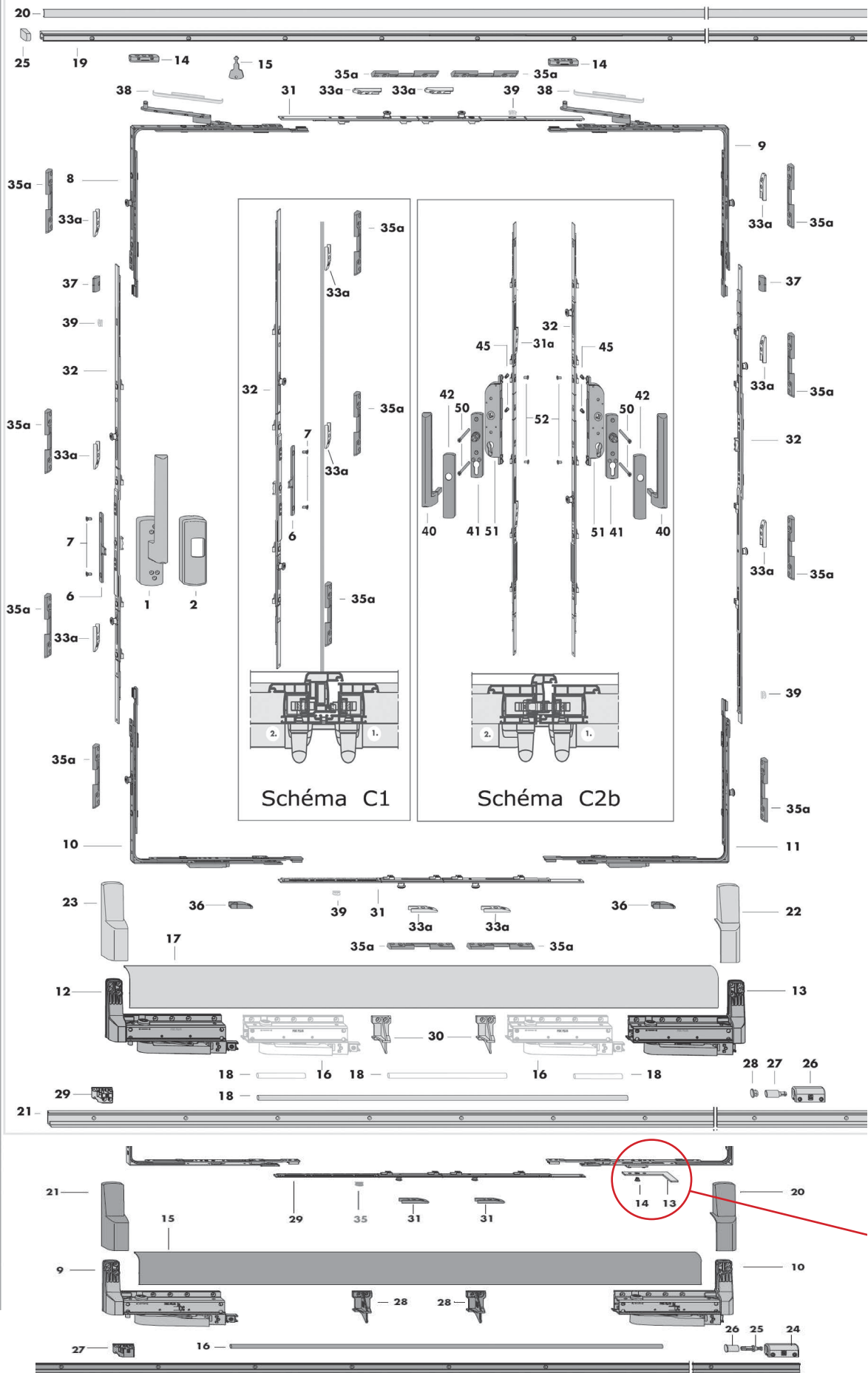
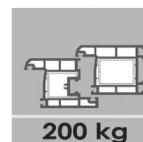

| Poz. | Položka          | Farba            | obj. číslo |           | počet ks v schéme |   |    |    |   |
|------|------------------|------------------|------------|-----------|-------------------|---|----|----|---|
|      |                  |                  | ľavá       | pravá     | A                 | G | C1 | C2 | K |
| 1-2  | Kľučka PSK200/GH | Biele RAL 9016   | 89-296325  | 89-296271 |                   |   |    |    |   |
|      |                  | Hnedá RAL 8022   | 89-297803  | 89-297797 | 1                 | 1 |    |    | 1 |
|      |                  | Strieborná EV1   | 89-296301  | 89-296257 |                   |   |    | 1  |   |
|      |                  | Bronz tmavý C 33 | 89-296349  | 89-296295 |                   |   |    |    | 1 |

| Poz.  | Položka                         | obj. číslo |           |            |                           | počet ks v schéme |           |           |      |   |
|-------|---------------------------------|------------|-----------|------------|---------------------------|-------------------|-----------|-----------|------|---|
|       |                                 | Biele      | Hnedá     | Strieborná | Bronz                     | A                 | G         | C1        | C2   | K |
| 6-11  | Prevod roh PSK 200-Z S-RS pravý | 9 mm       | 2/0       | 2/4        | PMEL0021-100010           |                   |           |           |      |   |
|       |                                 | 13 mm      | 2/0       | 2/4        | PMEL0011-100010           | 1                 | 1         | 0..1      | 0..1 | 1 |
|       |                                 | 9 mm       | 2/0       | 2/4        | PMEL0022-100010           |                   |           |           |      |   |
|       |                                 |            |           |            | PMEL0012-100010           |                   |           |           |      |   |
| 12-15 | Vozík PSK PLUS pravý            | 9 mm       | 2/0       | 2/4        | 89-003110                 | 1                 | 1         | 1         | 1    | 1 |
|       |                                 | 13 mm      | 2/0       | 2/4        | 89-003210                 |                   |           |           |      |   |
| 17-30 | Profil PSK PLUS veľkosť         | dĺžka      |           |            | predčísle PMPJ01xx-xxxxxx |                   |           |           |      |   |
|       |                                 | 87/200     | 670-870   | do 2000    | 00-502010                 | 00-512010         | 00-525010 | 00-531010 |      |   |
|       |                                 | 107/240    | 871-1070  | 2001-2400  | 10-502010                 | 10-512010         | 10-525010 | 10-531010 |      |   |
|       |                                 | 130/286    | 1071-1300 | 2401-2860  | 20-502010                 | 20-512010         | 20-525010 | 30-521010 |      |   |
|       |                                 | 160/346    | 1301-1600 | 2861-3460  | 30-502010                 | 30-512010         | 30-525010 | 30-531010 | 1    | 1 |



KF 12/20-9



KF 12/20-13

|    |                       |       |           |     |                           |                 |                 |           |   |   |   |
|----|-----------------------|-------|-----------|-----|---------------------------|-----------------|-----------------|-----------|---|---|---|
| 31 | Medzikus S-RS veľkosť | dĺžka | 1/0       | 0/1 | PZKL0270-100010           |                 |                 |           |   |   |   |
|    |                       | 100   | 770-1000  |     |                           |                 |                 |           |   |   |   |
|    |                       | 123   | 1001-1230 | 1/0 | 0/1                       | PZKL0280-100010 |                 |           |   |   |   |
|    |                       | 146   | 1231-1460 | 2/0 | 0/2                       | PZKL0290-100010 | 2               | 2         | 4 | 4 |   |
|    |                       | 169   | 1461-1690 | 2/0 | 0/2                       | PZKL0300-100010 |                 |           |   |   |   |
|    |                       | 192   | 1691-1920 | 2/0 | 0/2                       | PZKL0320-100010 |                 |           |   |   |   |
| 32 | Prevodka OS veľkosť   | dĺžka | -         | -   | 89-713303                 |                 |                 |           |   |   |   |
|    |                       | 123   | 1000-1230 | 490 |                           |                 |                 |           |   |   |   |
|    |                       | 146   | 1231-1460 | 590 | 1/0                       | 0/1             | PGKL0130-100030 | 2         | 2 | 4 | 4 |
|    |                       | 169   | 1461-1690 | 690 | 1/0                       | 0/1             | PGKL0140-100030 |           |   |   |   |
|    |                       | 192   | 1691-1920 | 990 | 2/0                       | 0/2             | PGKL0150-100030 |           |   |   |   |
|    |                       | 215   | 1921-2150 | 990 | 2/0                       | 0/2             | PGKL0160-100030 |           |   |   |   |
| 38 | Krytka S veľkosť      | dĺžka | 2/0       | 0/2 | predčísle PKAL00xx-xxxxxx | 2               | 2               | 4         | 4 |   |   |
|    |                       | 123   | 1000-1230 | 490 | 10-002010                 | 10-012010       | 10-025010       | 10-030010 |   |   |   |

| Poz.  | Položka                        | Profil | GEALAN          | SALAMANDER      | Pr. data list |
|-------|--------------------------------|--------|-----------------|-----------------|---------------|
|       |                                |        | A1940           | A2860           | A.....        |
| 33a   | Protiplech 56 pravý            |        | 89-712269       | 89-712290       | 89-.....      |
| 35a   | Protiplech S-RS PSK 200-Z ľavý |        | TRSK0600-100010 | TRSK0510-100010 | TRSK.....     |
| 36-37 | Rámový segment PSK 200 pravé   |        | 89-301234       | 89-301333       | 89-.....      |

|          |  |                       |           |           |                 |                 |      |      |      |  |
|----------|--|-----------------------|-----------|-----------|-----------------|-----------------|------|------|------|--|
| 31a      | Prevodka (s protiplechmi) veľkosť          | dĺžka                 |           |           | PZKL0250-100010 |                 |      |      |      |  |
|          |  | 169/2                 | 1460-1690 | 690       |                 |                 |      |      |      |  |
|          |  | 192                   | 1691-1920 | 990       |                 |                 |      |      |      |  |
|          | schéma C                                   | Prevodka S-RS veľkosť | dĺžka     |           |                 | PZKL0350-100010 |      |      |      |  |
|          |  |                       | 169/2     | 1460-1690 | 690             |                 |      |      |      |  |
|          |  |                       | 192       | 1691-1920 | 990             |                 |      |      |      |  |
| schéma C | Prevodka S-RS veľkosť                      | dĺžka                 |           |           | PZKL0360-100010 |                 |      |      |      |  |
|          |  | 169/2                 | 1460-1690 | 690       |                 |                 |      |      |      |  |
|          |  | 192                   | 1691-1920 | 990       |                 |                 |      |      |      |  |
| 16       | Vozík prídavný PSK PLUS (nad 160 kg) pravý | dĺžka                 |           |           | PMWL0031-100110 | 0..1            | 0..1 | 0..1 | 0..1 |  |
|          |  | 169/2                 | 1460-1690 | 690       |                 |                 |      |      |      |  |
|          |  | 192                   | 1691-1920 | 990       |                 |                 |      |      |      |  |

|           |                                    |            |           |           |           |                 |  |  |  |
|-----------|------------------------------------|------------|-----------|-----------|-----------|-----------------|--|--|--|
| 40-42     | Kľučka Si-Line HS schéma C         | Farba      | Kľučka    | Krytka    | Madlo     |                 |  |  |  |
|           |                                    | Biele      | 89-329689 | 89-876572 | 89-273340 |                 |  |  |  |
|           |                                    | Strieborná | 89-524014 | 89-876558 | 89-880838 |                 |  |  |  |
| 45        | Matica fixačného valčeka           |            |           | 89-800287 |           |                 |  |  |  |
| 51-52     | Prevodový set PSK 200-Z PZ-30      | DRM 30 mm  |           |           | 89-716335 |                 |  |  |  |
|           |                                    | PZ-40      | DRM 40 mm |           | 89-716342 |                 |  |  |  |
| 6a<br>11a | Prevod roh PSK 200-Z S-RS schéma C | pravý      | 9 mm      | 2/0       | 2/4       | PMEL0061-100010 |  |  |  |
|           |                                    |            | 13 mm     | 2/0       | 2/4       | PMEL0051-100010 |  |  |  |
|           |                                    | ľavý       | 9 mm      | 2/0       | 2/4       | PMEL0062-100010 |  |  |  |
|           |                                    |            | 13 mm     | 2/0       | 2/4       | PMEL0052-100010 |  |  |  |

Segment určujúci rozdiel medzi PSK 200-Z a PS 160-Z



Medzné rozmery krídel

|                 |                   |
|-----------------|-------------------|
| šírka krídla    | 720 mm - 3335 mm  |
| výška krídla    | 1190 mm - 3300 mm |
| hmotnosť krídla | 300 kg            |

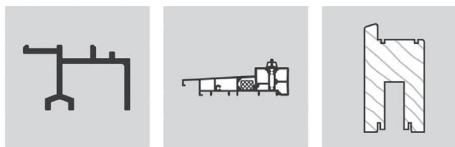

**HS-H** Schema G/H

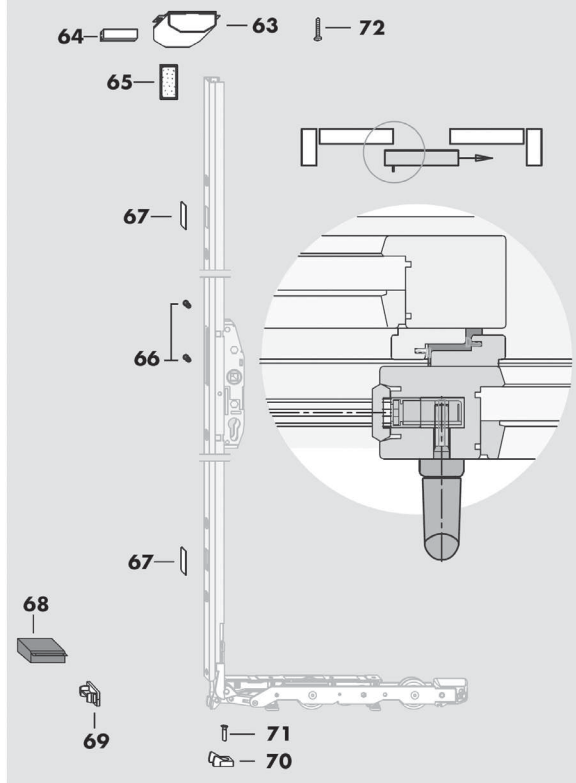

**HS-H** Schema C/F

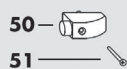
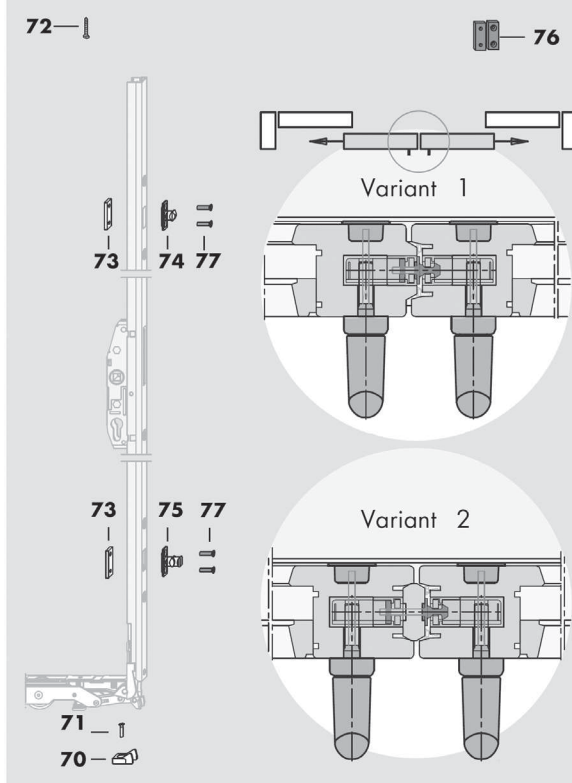

System pre profil:  
DREVO IV 56 - IV 68

**HH0131**

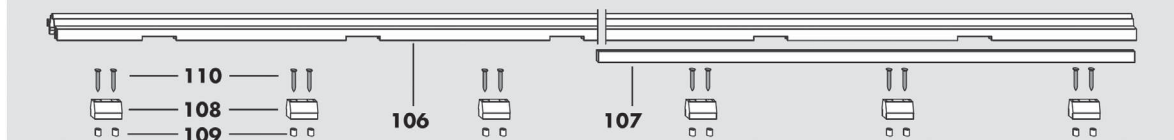

**SIEGENIA AUBI**  
SOLUTIONS INSIDE

# HS-PORTAL 300

Schema A

|                    |          |
|--------------------|----------|
| počet krídel       | 1        |
| max. šírka portálu | 6.700 mm |

Schema D

|                    |          |
|--------------------|----------|
| počet krídel       | 1        |
| max. šírka portálu | 9.900 mm |

Schema G

|                    |          |
|--------------------|----------|
| počet krídel       | 1        |
| max. šírka portálu | 9.900 mm |

Schema G2

|                    |          |
|--------------------|----------|
| počet krídel       | 1        |
| max. šírka portálu | 9.900 mm |

Schema H

|                    |          |
|--------------------|----------|
| počet krídel       | 3        |
| max. šírka portálu | 9.900 mm |

Schema C

|                    |           |
|--------------------|-----------|
| počet krídel       | 2         |
| max. šírka portálu | 13.300 mm |

Schema F

|                    |           |
|--------------------|-----------|
| počet krídel       | 2         |
| max. šírka portálu | 13.300 mm |

Schema K

|                    |           |
|--------------------|-----------|
| počet krídel       | 2         |
| max. šírka portálu | 13.300 mm |

Schema E

|                    |           |
|--------------------|-----------|
| počet krídel       | 2         |
| max. šírka portálu | 13.300 mm |

Schema L

|                    |           |
|--------------------|-----------|
| počet krídel       | 2         |
| max. šírka portálu | 13.300 mm |

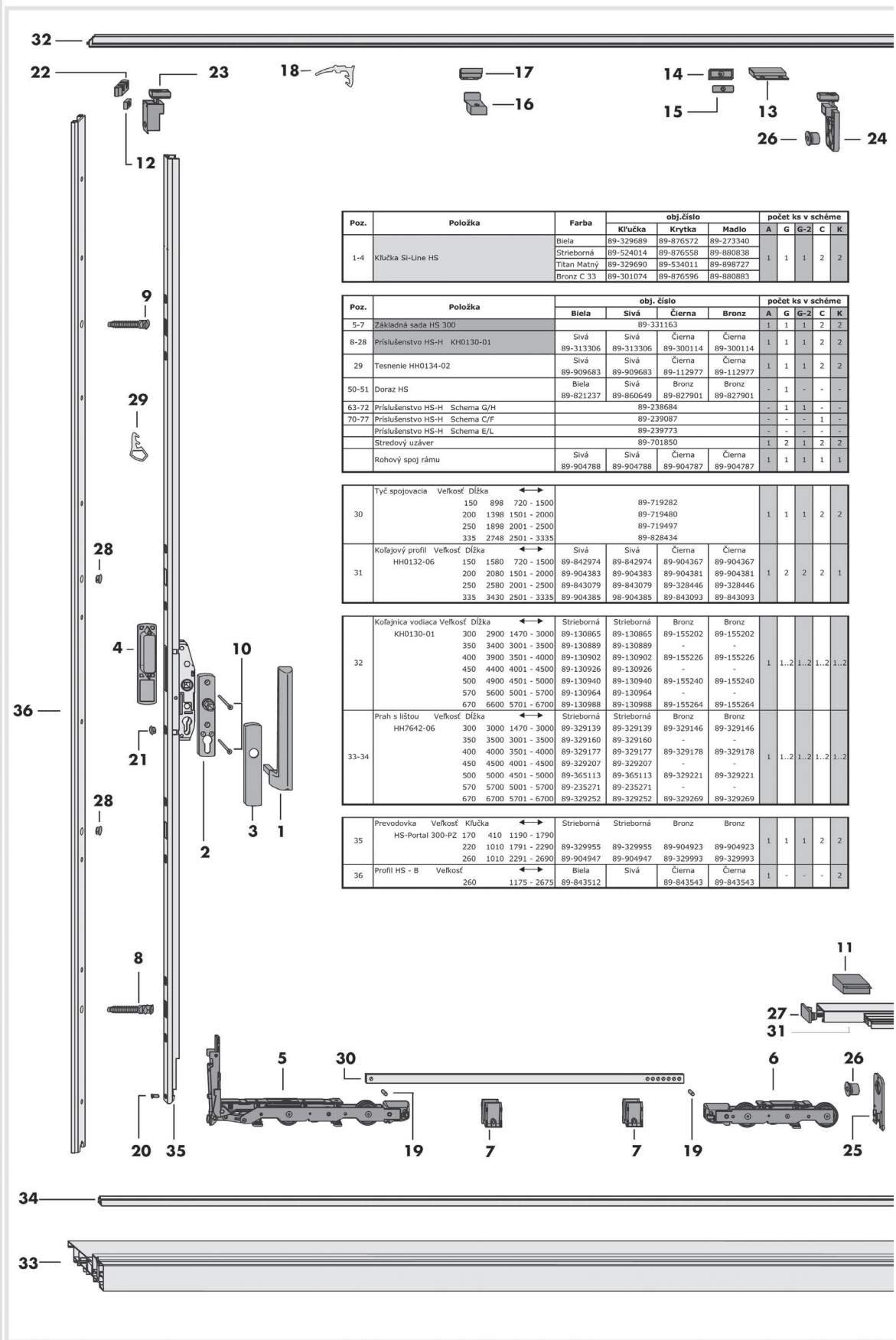

| Poz. | Položka           | Farba       | obj.číslo |           |           | počet ks v schéme |   |     |   |   |
|------|-------------------|-------------|-----------|-----------|-----------|-------------------|---|-----|---|---|
|      |                   |             | Kľučka    | Krytka    | Madlo     | A                 | G | G-2 | C | K |
| 1-4  | Kľučka SI-Line HS | Biela       | 89-829689 | 89-876572 | 89-273340 | 1                 | 1 | 1   | 2 | 2 |
|      |                   | Strieborná  | 89-524014 | 89-876558 | 89-880838 |                   |   |     |   |   |
|      |                   | Titan Matný | 89-329690 | 89-534011 | 89-898727 |                   |   |     |   |   |
|      |                   | Bronz C 33  | 89-301074 | 89-876596 | 89-880883 |                   |   |     |   |   |

| Poz.  | Položka                       | obj. číslo         |                   |                     |                     | počet ks v schéme |   |     |   |   |
|-------|-------------------------------|--------------------|-------------------|---------------------|---------------------|-------------------|---|-----|---|---|
|       |                               | Biela              | Sivá              | Čierna              | Bronz               | A                 | G | G-2 | C | K |
| 5-7   | Základná sada HS 300          | 89-331163          |                   |                     |                     | 1                 | 1 | 1   | 2 | 2 |
| 8-28  | Príslušenstvo HS-H KH0130-01  | Sivá<br>89-313306  | Sivá<br>89-313306 | Čierna<br>89-300114 | Čierna<br>89-300114 | 1                 | 1 | 1   | 2 | 2 |
| 29    | Tesnenie HH0134-02            | Sivá<br>89-909683  | Sivá<br>89-909683 | Čierna<br>89-112977 | Čierna<br>89-112977 | 1                 | 1 | 1   | 2 | 2 |
| 50-51 | Doraz HS                      | Biela<br>89-821237 | Sivá<br>89-860649 | Bronz<br>89-827901  | Bronz<br>89-827901  | -                 | 1 | -   | - | - |
| 63-72 | Príslušenstvo HS-H Schema G/H |                    |                   | 89-238684           |                     | -                 | 1 | 1   | - | - |
| 70-77 | Príslušenstvo HS-H Schema C/F |                    |                   | 89-239087           |                     | -                 | - | -   | 1 | - |
|       | Príslušenstvo HS-H Schema E/L |                    |                   | 89-239773           |                     | -                 | - | -   | - | - |
|       | Stredový uzáver               |                    |                   | 89-701850           |                     | 1                 | 2 | 1   | 2 | 2 |
|       | Rohový spoj rámu              | Sivá<br>89-904788  | Sivá<br>89-904788 | Čierna<br>89-904787 | Čierna<br>89-904787 | 1                 | 1 | 1   | 1 | 1 |

| Poz. | Tyč spojovacia            | Veľkosť | Dĺžka | obj. číslo |             |             |           | počet ks v schéme |           |           |   |   |
|------|---------------------------|---------|-------|------------|-------------|-------------|-----------|-------------------|-----------|-----------|---|---|
|      |                           |         |       | Sivá       | Sivá        | Čierna      | Čierna    | A                 | G         | G-2       | C | K |
| 30   |                           |         | 150   | 898        | 720 - 1500  | 89-719282   |           |                   |           |           |   |   |
|      |                           |         | 200   | 1398       | 1501 - 2000 | 89-719480   |           |                   |           |           |   |   |
|      |                           |         | 250   | 1898       | 2001 - 2500 | 89-719497   |           |                   |           |           |   |   |
|      |                           |         | 335   | 2748       | 2501 - 3335 | 89-828434   |           |                   |           |           |   |   |
| 31   | Kofajový profil HH0132-06 | Veľkosť | Dĺžka | 150        | 1580        | 720 - 1500  | 89-842974 | 89-842974         | 89-904367 | 89-904367 |   |   |
|      |                           |         |       | 200        | 2080        | 1501 - 2000 | 89-904383 | 89-904383         | 89-904381 | 89-904381 | 1 | 2 |
|      |                           |         |       | 250        | 2580        | 2001 - 2500 | 89-843079 | 89-843079         | 89-328446 | 89-328446 |   |   |
|      |                           |         |       | 335        | 3430        | 2501 - 3335 | 89-904385 | 89-904385         | 89-843093 | 89-843093 |   |   |

| Poz. | Kofajnica vodiaca KH0130-01 | Veľkosť     | Dĺžka     | obj. číslo |                         |             |           | počet ks v schéme |           |             |           |           |
|------|-----------------------------|-------------|-----------|------------|-------------------------|-------------|-----------|-------------------|-----------|-------------|-----------|-----------|
|      |                             |             |           | Strieborná | Strieborná              | Bronz       | Bronz     | A                 | G         | G-2         | C         | K         |
| 32   |                             |             |           | 300        | 2900                    | 1470 - 3000 | 89-130865 | 89-130865         | 89-155202 | 89-155202   |           |           |
|      |                             |             |           | 350        | 3400                    | 3001 - 3500 | 89-130889 | 89-130889         | -         | -           |           |           |
|      |                             |             |           | 400        | 3900                    | 3501 - 4000 | 89-130902 | 89-130902         | 89-155226 | 89-155226   | 1         | 1.2       |
|      |                             |             |           | 450        | 4400                    | 4001 - 4500 | 89-130926 | 89-130926         | -         | -           | 1.2       | 1.2       |
|      |                             |             |           | 500        | 4900                    | 4501 - 5000 | 89-130940 | 89-130940         | 89-155240 | 89-155240   | 1.2       | 1.2       |
|      |                             |             |           | 570        | 5600                    | 5001 - 5700 | 89-130964 | 89-130964         | -         | -           |           |           |
|      |                             |             |           | 670        | 6600                    | 5701 - 6700 | 89-130988 | 89-130988         | 89-155264 | 89-155264   |           |           |
|      |                             |             |           | 33-34      | Prah s lištou HH7642-06 | Veľkosť     | Dĺžka     | 300               | 3000      | 1470 - 3000 | 89-329139 | 89-329139 |
| 350  | 3500                        | 3001 - 3500 | 89-329160 |            |                         |             |           | 89-329160         | -         | -           |           |           |
| 400  | 4000                        | 3501 - 4000 | 89-329177 |            |                         |             |           | 89-329177         | 89-329178 | 89-329178   | 1         |           |
| 450  | 4500                        | 4001 - 4500 | 89-329207 |            |                         |             |           | 89-329207         | -         | -           | 1.2       |           |
| 500  | 5000                        | 4501 - 5000 | 89-365113 |            |                         |             |           | 89-365113         | 89-329221 | 89-329221   | 1.2       |           |
| 570  | 5700                        | 5001 - 5700 | 89-235271 |            |                         |             |           | 89-235271         | -         | -           | 1.2       |           |
| 670  | 6700                        | 5701 - 6700 | 89-329252 |            |                         |             |           | 89-329252         | 89-329269 | 89-329269   | 1.2       |           |

| Poz. | Prevodovka HS-Portal 300-PZ | Veľkosť | Kľučka | obj. číslo  |            |           |             | počet ks v schéme |           |           |           |   |
|------|-----------------------------|---------|--------|-------------|------------|-----------|-------------|-------------------|-----------|-----------|-----------|---|
|      |                             |         |        | Strieborná  | Strieborná | Bronz     | Bronz       | A                 | G         | G-2       | C         | K |
| 35   |                             | 170     | 410    | 1190 - 1790 | 89-329955  | 89-329955 | 89-904923   | 89-904923         | 1         | 1         | 1         | 2 |
|      |                             |         |        |             | 89-904947  | 89-904947 | 89-329993   | 89-329993         |           |           |           |   |
|      |                             |         |        |             | 260        | 1010      | 2291 - 2690 | 89-904947         | 89-904947 | 89-329993 | 89-329993 |   |

| Poz. | Profil HS - B | Veľkosť | obj. číslo  |           |        |        | počet ks v schéme |   |     |   |
|------|---------------|---------|-------------|-----------|--------|--------|-------------------|---|-----|---|
|      |               |         | Biela       | Sivá      | Čierna | Čierna | A                 | G | G-2 | C |
| 36   |               | 260     | 1175 - 2675 | 89-843512 |        |        |                   |   |     |   |

Medzné rozmery krídel

|                 |                   |
|-----------------|-------------------|
| šírka krídla    | 720 mm - 3335 mm  |
| výška krídla    | 1190 mm - 3300 mm |
| hmotnosť krídla | 300 kg            |



24

**HS-H** Schema G/H

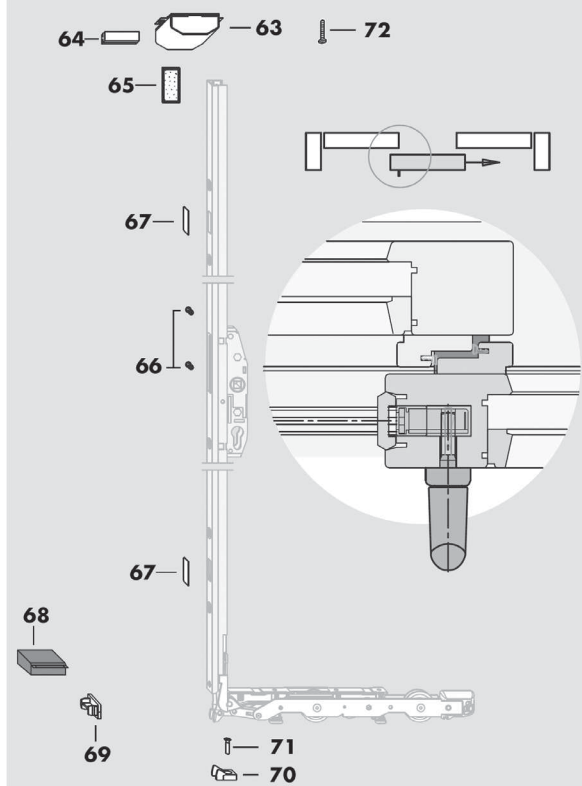

**HS-H** Schema C/F

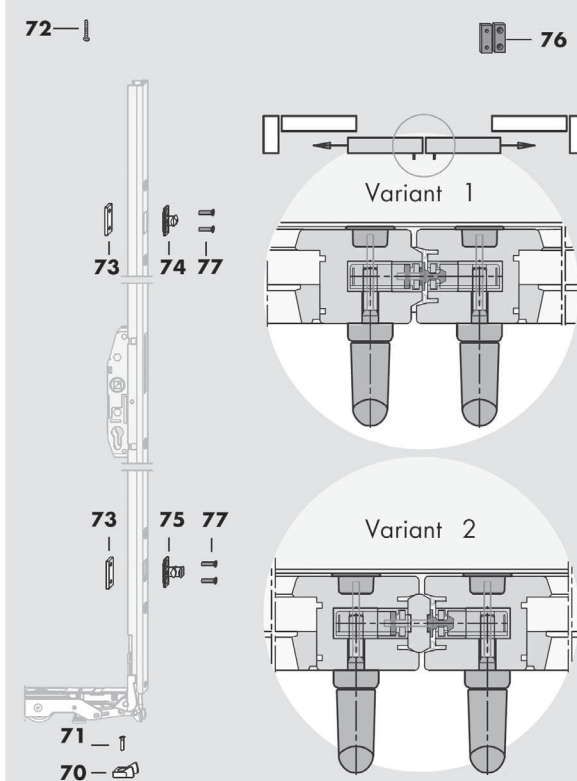

System pre profil:  
DREVO IV 56 - IV 92

**SIEGENIA AUBI**  
SOLUTIONS INSIDE

# HS-PORTAL 300

**Schema A**



|                    |          |
|--------------------|----------|
| počet krídel       | 1        |
| max. šírka portálu | 6.700 mm |

**Schema D**

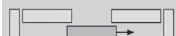
|                    |          |
|--------------------|----------|
| počet krídel       | 2        |
| max. šírka portálu | 6.700 mm |

**Schema G**

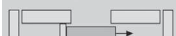
|                    |          |
|--------------------|----------|
| počet krídel       | 1        |
| max. šírka portálu | 9.900 mm |

**Schema G2**

|                    |          |
|--------------------|----------|
| počet krídel       | 1        |
| max. šírka portálu | 9.900 mm |

**Schema H**

**Schema C**

|                    |           |
|--------------------|-----------|
| počet krídel       | 2         |
| max. šírka portálu | 13.300 mm |

**Schema F**

|                    |           |
|--------------------|-----------|
| počet krídel       | 4         |
| max. šírka portálu | 13.300 mm |

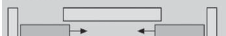
**Schema K**

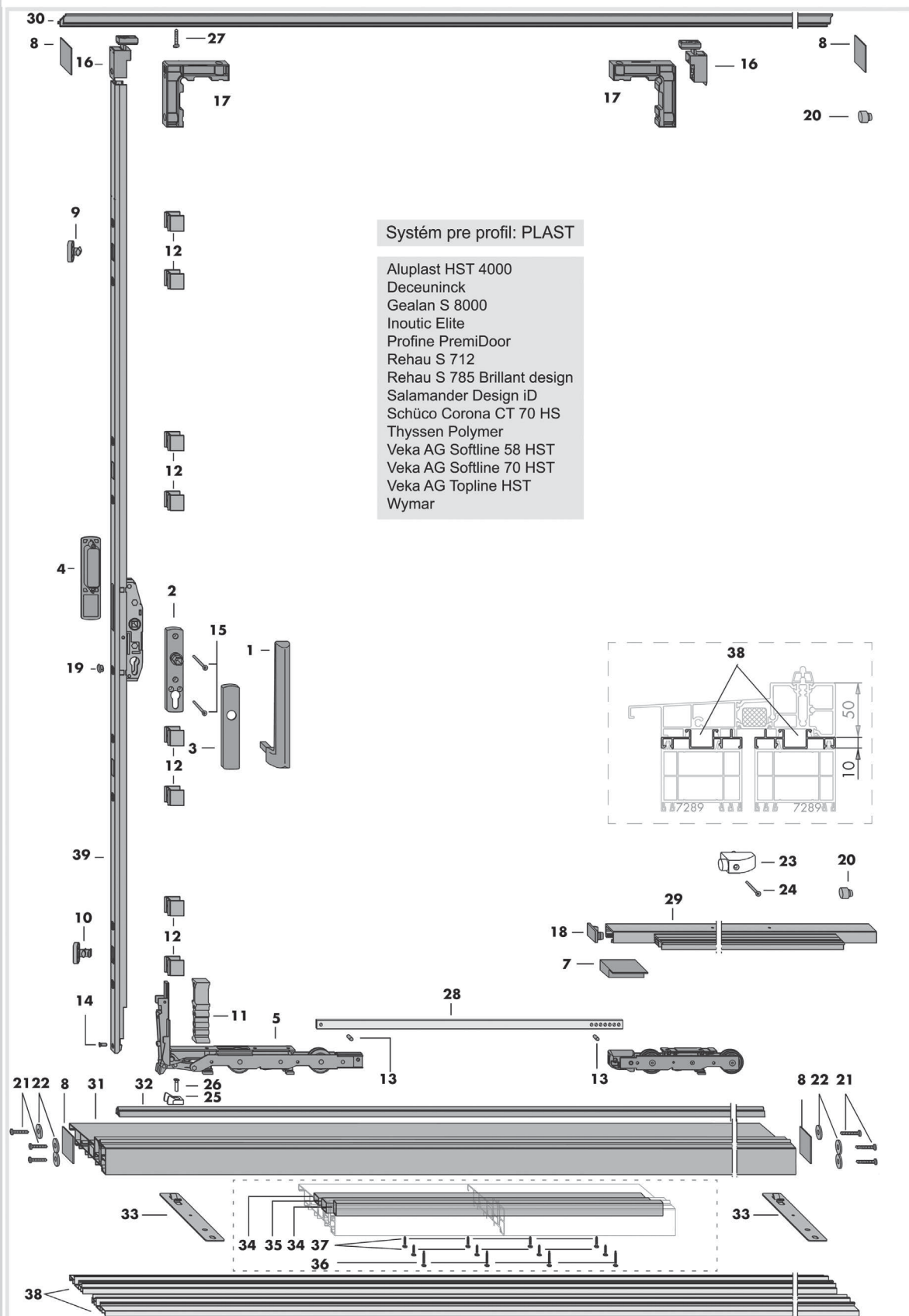
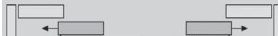
**Schema E**

**Schema L**

**Systém pre profil: PLAST**

Aluplast HST 4000  
 Deceuninck  
 Gealan S 8000  
 Inoutic Elite  
 Profine PremiDoor  
 Rehau S 712  
 Rehau S 785 Brillant design  
 Salamander Design iD  
 Schüco Corona CT 70 HS  
 Thyssen Polymer  
 Veka AG Softline 58 HST  
 Veka AG Softline 70 HST  
 Veka AG Topline HST  
 Wymar

Vyobrazená schéma je pre profil Gealan S 8000



### Medzné rozmery krídla

|                 |                   |
|-----------------|-------------------|
| šírka krídla    | 720 mm - 3335 mm  |
| výška krídla    | 1190 mm - 3300 mm |
| hmotnosť krídla | 300 kg            |



| Položka           | Farba       | obj. číslo |           |           | počet ks v schéme |   |   |     |   |   |  |
|-------------------|-------------|------------|-----------|-----------|-------------------|---|---|-----|---|---|--|
|                   |             | Kľučka     | Krytka    | Madlo     | A                 | D | G | G-2 | C | F |  |
| Kľučka Si-Line HS | Biela       | 89-329689  | 89-876572 | 89-273340 |                   |   |   |     |   |   |  |
|                   | Strieborná  | 89-524014  | 89-876558 | 89-880838 | 1                 | 2 | 1 | 1   | 2 | 4 |  |
|                   | Titan Matný | 89-329690  | 89-534011 | 89-898727 |                   |   |   |     |   |   |  |
|                   | Bronz C 33  | 89-301074  | 89-876596 | 89-880883 |                   |   |   |     |   |   |  |

| Základná sada HS 300 KF |                       |       |            | počet ks v schéme |   |   |     |   |   |
|-------------------------|-----------------------|-------|------------|-------------------|---|---|-----|---|---|
| Výrobca                 | Profil                | kód   | obj. číslo | A                 | D | G | G-2 | C | F |
| Aluplast                | HST 4000              | A0022 | 89-308837  | 1                 | 2 | - | -   | 2 | 4 |
| Deceuninck              |                       | A0085 | 89-239131  | 1                 | 2 | 1 | -   | 2 | 4 |
| Gealan                  | S 8000                | A0219 | 89-328873  | 1                 | - | - | -   | 2 | - |
| Inoutic Elite           |                       | A0280 | PMKB4220   | 1                 | - | 1 | -   | 2 | - |
| Profine (Trocal)        | PremiDoor             | A0213 | PMKB4020   | 1                 | 2 | - | -   | 2 | 4 |
| Rehau                   | S 712                 | A0002 | 89-238714  | 1                 | 2 | 1 | -   | 2 | 4 |
|                         | S 785 Brillant Design | A0218 | PMKB4030   | 1                 | - | - | -   | 2 | - |
| Salamander              | Design Id             | A0202 | 89-309735  | 1                 | - | - | 1   | 2 | - |
| Schüco                  | Corona CT 70 HS       | A0206 | PMKB4000   | 1                 | 2 | 1 | -   | 2 | 4 |
| Thyssen Polymer         |                       | A0006 | 89-238738  | 1                 | - | - | -   | 2 | - |
| Veka AG                 | Softline (58) HST     | A0017 | 89-239322  | 1                 | 2 | - | -   | 2 | 4 |
|                         | Topline HST           | A0209 | PMKB4010   | 1                 | 2 | - | -   | 2 | 4 |
|                         | Softline 70 HST       | A0209 | PMKB4010   | 1                 | 2 | - | -   | 2 | 4 |
| Wymar                   |                       | A0195 | PMKB4210   | 1                 | 2 | 1 | -   | 2 | 4 |

| Tyč spojovacia              | Veľkosť | Dĺžka      |             |            |            |           |           |   |   |
|-----------------------------|---------|------------|-------------|------------|------------|-----------|-----------|---|---|
| 150                         | 898     | 720 - 1500 |             | 89-719282  |            |           |           |   |   |
|                             | 200     | 1398       | 1501 - 2000 | 89-719480  | 1          | 2         | 1         | 1 | 2 |
|                             | 250     | 1898       | 2001 - 2500 | 89-719497  |            |           |           |   |   |
|                             | 335     | 2748       | 2501 - 3335 | 89-828434  |            |           |           |   |   |
| Prevodovka HS-Portal 300-PZ | 170     | 410        | 1190 - 1790 | Strieborná | Strieborná | Bronz     | Bronz     |   |   |
|                             | 220     | 1010       | 1791 - 2290 | 89-329955  | 89-329955  | 89-904923 | 89-904923 | 1 | 2 |
|                             | 260     | 1010       | 2291 - 2690 | 89-904947  | 89-904947  | 89-329993 | 89-329993 | 1 | 2 |
|                             |         |            |             |            |            |           |           | 1 | 2 |

| Koľajnica vodiaca       | Veľkosť | Dĺžka |             | Strieborná | Strieborná | Bronz     | Bronz     |   |   |     |     |     |     |
|-------------------------|---------|-------|-------------|------------|------------|-----------|-----------|---|---|-----|-----|-----|-----|
| KH0130-01               | 300     | 2900  | 1470 - 3000 | 89-130865  | 89-130865  | 89-155202 | 89-155202 |   |   |     |     |     |     |
|                         | 350     | 3400  | 3001 - 3500 | 89-130889  | 89-130889  | -         | -         |   |   |     |     |     |     |
|                         | 400     | 3900  | 3501 - 4000 | 89-130902  | 89-130902  | 89-155226 | 89-155226 | 1 | 1 | 1.2 | 1.2 | 1.2 | 1.2 |
|                         | 450     | 4400  | 4001 - 4500 | 89-130926  | 89-130926  | -         | -         |   |   |     |     |     |     |
|                         | 500     | 4900  | 4501 - 5000 | 89-130940  | 89-130940  | 89-155240 | 89-155240 |   |   |     |     |     |     |
|                         | 570     | 5600  | 5001 - 5700 | 89-130964  | 89-130964  | -         | -         |   |   |     |     |     |     |
|                         | 670     | 6600  | 5701 - 6700 | 89-130988  | 89-130988  | 89-155264 | 89-155264 |   |   |     |     |     |     |
| Prah s lištou HH7642-06 | 300     | 3000  | 1470 - 3000 | 89-329139  | 89-329139  | 89-329146 | 89-329146 |   |   |     |     |     |     |
|                         | 350     | 3500  | 3001 - 3500 | 89-329160  | 89-329160  | -         | -         |   |   |     |     |     |     |
|                         | 400     | 4000  | 3501 - 4000 | 89-329177  | 89-329177  | 89-329178 | 89-329178 | 1 | 1 | 1.2 | 1.2 | 1.2 | 1.2 |
|                         | 450     | 4500  | 4001 - 4500 | 89-329207  | 89-329207  | -         | -         |   |   |     |     |     |     |
|                         | 500     | 5000  | 4501 - 5000 | 89-365113  | 89-365113  | 89-329221 | 89-329221 |   |   |     |     |     |     |
|                         | 570     | 5700  | 5001 - 5700 | 89-235271  | 89-235271  | -         | -         |   |   |     |     |     |     |
|                         | 670     | 6700  | 5701 - 6700 | 89-329252  | 89-329252  | 89-329269 | 89-329269 |   |   |     |     |     |     |

| Výrobca          | Profil                | Koľajnica vodiaca KH0130-01 | Prah s lištou HH7642-06 |
|------------------|-----------------------|-----------------------------|-------------------------|
| Aluplast         | HST 4000              | NIE                         | NIE                     |
| Deceuninck       |                       | NIE                         | ANO                     |
| Gealan           | S 8000                | ANO                         | ANO                     |
| Inoutic Elite    |                       | NIE                         | NIE                     |
| Profine (Trocal) | PremiDoor             | NIE                         | NIE                     |
| Rehau            | S 712                 | NIE                         | ANO                     |
|                  | S 785 Brillant Design | NIE                         | ANO                     |
| Salamander       | Design Id             | NIE                         | ANO                     |
| Schüco           | Corona CT 70 HS       | NIE                         | NIE                     |
| Thyssen Polymer  |                       | NIE                         | NIE                     |
| Veka AG          | Softline (58) HST     | NIE                         | ANO                     |
|                  | Topline HST           | NIE                         | ANO                     |
|                  | Softline 70 HST       | NIE                         | ANO                     |
| Wymar            |                       | NIE                         | NIE                     |

Ostatné príslušenstvo treba vyšpecifikovať podľa konkrétneho profilu !!!

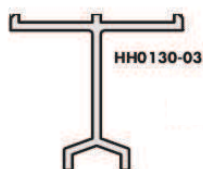
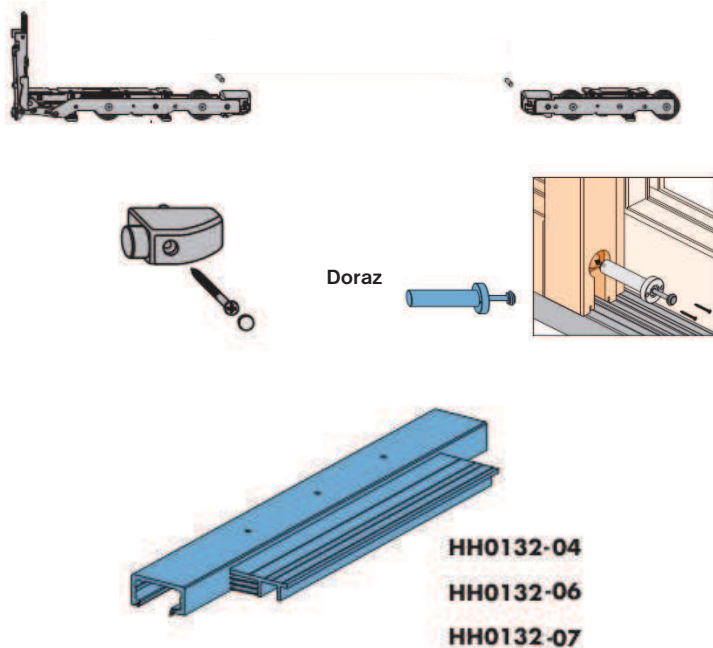

#### VOZÍKY

| Typ                                       | Obj. číslo |
|---|------------|
| SA-HS, 200-H, ZÁKL.SADA                   | 89-329061  |
| SA-HS, 300-H, POC.DOOR, ZÁKL.SADA         | 89-010001  |
| SA-HS, 300-H, ZÁKL.SADA                   | 89-331163  |
| SA-HS, 300-HV, ZÁKL.SADA S REGULÁCIOU,3MM | 89-399244  |
| SA-HS, 400-H, ZÁKL.SADA                   | 89-328347  |

#### DORAZ

| Typ                          | Obj. číslo |
|------------------------------|------------|
| SA-HS, DORAZ HS, R7040       | 89-860649  |
| SA-HS, DORAZ HS, TLMENÝ      | 89-855555  |
| SA-HS, DORAZ, B1 / 20, R9005 | 89-831922  |

#### VIROVNÁVACÍ PROFIL

| Typ                                 | Obj. číslo |
|-------------------------------------|------------|
| SA-HS, KOL.PR.HH0132-04GR150,R9005  | 89-842973  |
| SA-HS, KOL.PR.HH0132-04GR200,R9005  | 89-843017  |
| SA-HS, KOL.PR.HH0132-04GR250,R9005  | 89-843055  |
| SA-HS, KOL.PR.HH0132-06,GR150,R9005 | 89-904367  |
| SA-HS, KOL.PR.HH0132-06,GR200,R9005 | 89-904381  |
| SA-HS, KOL.PR.HH0132-06,GR250,R9005 | 89-328446  |
| SA-HS, KOL.PR.HH0132-06,GR335,R9005 | 89-843093  |
| SA-HS, KOL.PR.HH0132-06GR150,R7040  | 89-842974  |
| SA-HS, KOL.PR.HH0132-06GR200,R7040  | 89-904383  |
| SA-HS, KOL.PR.HH0132-06GR250,R7040  | 89-843079  |
| SA-HS, KOL.PR.HH0132-06GR335,R7040  | 89-904385  |
| SA-HS, KOL.PR.HH0132-07GR200,R7040  | 89-890720  |
| SA-HS, KOL.PR.HH0132-07GR335,R7040  | 89-890735  |

#### PARALELNÁ KOLAJ

| Typ                                       | Obj. číslo |
|---|------------|
| SA-HS, KOL.VOD.HH0131,,GR300,C34,PARAL.KO | 89-126134  |
| SA-HS, KOL.VOD.HH0131,,GR400,C34,PARAL.KO | 89-126172  |
| SA-HS, KOL.VOD.HH0131,GR.670,C34,PARAL.KO | 89-126257  |
| SA-HS, KOL.VOD.HH0131,GR300,EV1,PARAL.KO  | 89-126127  |
| SA-HS, KOL.VOD.HH0131,GR400,EV1,PARAL.KO  | 89-126165  |
| SA-HS, KOL.VOD.HH0131,GR670,EV1,PARAL.KO  | 89-126240  |

#### VRCHNÉ VEDENIE KH 0130-1

| Typ                                 | Obj. číslo |
|-------------------------------------|------------|
| SA-HS, KOL.VOD.KH0130-01,GR.300,EV1 | 89-130865  |
| SA-HS, KOL.VOD.KH0130-01,GR.350,EV1 | 89-130889  |
| SA-HS, KOL.VOD.KH0130-01,GR.400,EV1 | 89-130902  |
| SA-HS, KOL.VOD.KH0130-01,GR.450,EV1 | 89-130926  |
| SA-HS, KOL.VOD.KH0130-01,GR.500,EV1 | 89-130940  |
| SA-HS, KOL.VOD.KH0130-01,GR.670,EV1 | 89-130988  |
| SA-HS, KOL.VOD.KH0130-01GR.300,C33  | 89-155202  |
| SA-HS, KOL.VOD.KH0130-01GR.400,C33  | 89-155226  |
| SA-HS, KOL.VOD.KH0130-01GR.500,C33  | 89-155240  |
| SA-HS, KOL.VOD.KH0130-01GR.670,C33  | 89-155264  |

#### VRCHNÉ VEDENIE HH0130-03

| Typ                               | Obj. číslo |
|-----------------------------------|------------|
| SA-HS, KOL.VOD.HH0130-03,GR500,F1 | 89-126813  |
| SA-HS, KOL.VOD.HH0130-03,GR670,F1 | 89-126837  |
| SA-HS, KOL.VOD.HH0130-03GR500,C34 | 89-126820  |
| SA-HS, KOL.VOD.HH0130-03GR670,C34 | 89-126844  |

#### VRCHNÉ VEDENIE HH0130-04

| Typ                               | Obj. číslo |
|-----------------------------------|------------|
| SA-HS, KOL.VOD.HH0130-04,GR350,F1 | 89-114350  |
| SA-HS, KOL.VOD.HH0130-04,GR450,F1 | 89-114450  |
| SA-HS, KOL.VOD.HH0130-04,GR670,F1 | 89-114670  |

#### SPODNÝ PRAH HH7642-06

| Typ                                 | Obj. číslo |
|-------------------------------------|------------|
| SA-HS, LIŠTA P,HH7642-06,GR270,EV1, | 89-333239  |
| SA-HS, LIŠTA P,HH7642-06,GR300,EV1, | 89-329139  |
| SA-HS, LIŠTA P,HH7642-06,GR335,EV1, | 89-329439  |
| SA-HS, LIŠTA P,HH7642-06,GR350,EV1  | 89-329160  |
| SA-HS, LIŠTA P,HH7642-06,GR370,EV1, | 89-333229  |
| SA-HS, LIŠTA P,HH7642-06,GR400,EV1, | 89-329177  |
| SA-HS, LIŠTA P,HH7642-06,GR450,EV1  | 89-329207  |
| SA-HS, LIŠTA P,HH7642-06,GR500,EV1  | 89-365113  |
| SA-HS, LIŠTA P,HH7642-06,GR570,EV1  | 89-235271  |
| SA-HS, LIŠTA P,HH7642-06,GR670,EV1  | 89-329252  |
| SA-HS, LIŠTA P,HH7642-06GR300,C33   | 89-329146  |
| SA-HS, LIŠTA P,HH7642-06GR400,C33   | 89-329178  |
| SA-HS, LIŠTA P,HH7642-06GR500,C33   | 89-329221  |
| SA-HS, LIŠTA P,HH7642-06GR670,C33   | 89-329269  |

**SPODNÝ PRAH HH7642-07**

| Typ                                      | Obj. číslo |
|--|------------|
| SA-HS,LIŠTA P,HH7642-07,GR270,EV1        | 89-890729  |
| SA-HS,LIŠTA P,HH7642-07,GR300,EV1        | 89-890730  |
| SA-HS,LIŠTA P,HH7642-07,GR335,EV1        | 89-890738  |
| SA-HS,LIŠTA P,HH7642-07,GR350,EV1        | 89-890731  |
| SA-HS,LIŠTA P,HH7642-07,GR400,EV1        | 89-890732  |
| SA-HS,LIŠTA P,HH7642-07,GR450,EV1        | 89-890733  |
| SA-HS,LIŠTA P,HH7642-07,GR570,EV1        | 89-890570  |
| SA-HS,LIŠTA P,HH7642-07,GR670,EV1        | 89-890737  |
| SA-HS,ADAPTÉR,HH7642-06A,GEALAN,GR670,EV | 89-338438  |

**SPODNÝ PRAH HH7652-07 (na schému „E,L“)**

| Typ                                     | Obj. číslo |
|---|------------|
| SA-HS,LIŠTA P,HH7652-07,GR500,EV1,"E,L" | 89-251120  |
| SA-HS,LIŠTA P,HH7652-07,GR670,EV1,"E,L" | 89-251121  |

**PRÍSLUŠENSTVO K PRAHOM**

| Typ                                      | Obj. číslo |
|--|------------|
| SA-HS,LIŠTA P,HH7652-06,SPOJENIE PRAHU,A | 89-355555  |
| SA-HS,LIŠTA ROZŠ. 2,5CM,HH7646,GR670,EV1 | 89-128343  |
| SA-HS,LIŠTA ROZŠ. 3,5CM,HH7646,GR670,EV1 | 89-128344  |

**PREVODOVKY**

| Typ                                      | Obj. číslo |
|--|------------|
| SA-HS,PREVODKA HS200-PZ,GR220,C34        | 89-903360  |
| SA-HS,PREVODKA HS200-PZ,GR220,EV1        | 89-326596  |
| SA-HS,PREVODKA HS200-PZ,GR260,C34        | 89-326626  |
| SA-HS,PREVODKA HS200-PZ,GR260,EV1        | 89-903377  |
| SA-HS,PREVODKA HS300-PZ,GR220,C34        | 89-904923  |
| SA-HS,PREVODKA HS300-PZ,GR220,EV1        | 89-329955  |
| SA-HS,PREVODKA HS300-PZ,GR220,EV1,KOMFOR | 89-399345  |
| SA-HS,PREVODKA HS300-PZ,GR260,C34        | 89-329993  |
| SA-HS,PREVODKA HS300-PZ,GR260,EV1        | 89-904947  |
| SA-HS,300-H,POC.DOOR,PREV.GR260,EV1-O    | 89-010002  |

**PREDLŽENIE PREVODOVKY**

| Typ                                   | Obj. číslo |
|---------------------------------------|------------|
| SA-HS,PREDLŽENIE,PREV,POCKET DOOR,EV1 | 89-010003  |
| SA-HS,PREDLŽENIE,PREV,C34-O           | 89-324059  |
| SA-HS,PREDLŽENIE,PREV,EV1-O           | 89-324042  |
| SA-HS,PREDLŽENIE,PROTIBEŽNÉ           | 89-324060  |

**PRISLUŠENSTVO**

| Typ                                  | Obj. číslo |
|--------------------------------------|------------|
| SA-HS,PRISL.HS-H,HH0130-01/02,R9005  | 89-313305  |
| SA-HS,PRISL.HS-H,HH0130-01/02,R7040  | 89-235349  |
| SA-HS,PRISL.HS-H,KH0130-01,R7040     | 89-313306  |
| SA-HS,PRISL.HS-H,KH0130-01,R9005     | 89-300114  |
| SA-HS,PRISLUŠENSTVO/SCHÉMA C/F       | 89-239087  |
| SA-HS,PRISLUŠENSTVO/SCHÉMA E/L       | 89-239773  |
| SA-HS,PRISLUŠENSTVO/SCHÉMA G/H       | 89-238684  |
| SA-HS,PROTIKUS PRÍDAVNÝ,DOLNÝ,E,60MM | 89-719169  |
| SA-HS,PROTIKUS PRÍDAVNÝ,HORNÝ,E,60MM | 89-719152  |

**DORAZOVÝ PROFIL / VÝPLŇOVÝ PROFIL**

| Typ                                   | Obj. číslo |
|---------------------------------------|------------|
| SA-HS,PROFIL HS,B,GR260,BIELY         | 89-843512  |
| SA-HS,PROFIL HS,B,GR260,ČIERNY        | 89-843543  |
| SA-HS,PROFIL HS,B,GR260,R7040         | 89-843522  |
| SA-HS,PROFIL,VYPLŇOVACÍ,45,L15M,R7040 | 89-891231  |
| SA-HS,PROFIL,VYPLŇOVACÍ,67,L15M,R7040 | 89-891223  |

**SPOJ**

| Typ                                      | Obj. číslo |
|--|------------|
| SA-HS,SPOJ.ROH.RÁ,7642-06,56/3,ČIE,SADA  | 89-904787  |
| SA-HS,SPOJ.ROH.RÁ,7642-06,56/3,SIV,KUS   | 89-904333  |
| SA-HS,SPOJ.ROH.RÁ,7642-06,56/3,SIV,SADA  | 89-904788  |
| SA-HS,SPOJ.ROH.RÁ,7642-07,56/1,78SIV,SAD | 89-904789  |
| SA-HS,SPOJ.ROH.RÁ,7642-07,56/3,92SIV,SAD | 89-904792  |
| SA-HS,SPOJ.ROHRÁM,7642-06,56/4,EL,SIV,KU | 89-904793  |
| SA-HS,ROZŠÍRENIE SPOJ.ROH,56/25/27-O     | 89-099030  |

**TESNENIE**

| Typ                                      | Obj. číslo |
|--|------------|
| SA-HS,TESNENIE HH0134-02,BM ČIERNE       | 89-127124  |
| SA-HS,TESNENIE HH0134-02,BM SIVE,R7040   | 89-127999  |
| SA-HS,TESNENIE HH0134-02,GR1,2,7M,R7040  | 89-113499  |
| SA-HS,TESNENIE HH0134-02,GR1,2,7M,R9005  | 89-112980  |
| SA-HS,TESNENIE HH0134-02,GR2,3,4M,R9005  | 89-112978  |
| SA-HS,TESNENIE HH0134-02,L17,5,R7040     | 89-909683  |
| SA-HS,TESNENIE HH0134-02,L17,5,R9005     | 89-112977  |
| SA-HS,TESNENIE HORNÉ,30x90x30,SCH:D      | 89-801173  |
| SA-HS,TESNENIE LIŠTY "C" PLÁTNÍČKA,43/20 | 89-119923  |
| SA-HS,TESNENIE LIŠTY "C" SPODOK,R9005    | 89-112979  |
| SA-HS,TESNENIE,POD "C" PROFIL R7040,92   | 89-800853  |
| SA-HS,TESNENIE,VRCH-SPODOK,R7040         | 89-843507  |
| SA-HS,TESNENIE,VRCH-SPODOK,R9005 NEW,    | 89-843506  |

| Typ                              | Obj. číslo |
|----------------------------------|------------|
| SA-HS,TYČ SPOJOVACIA,GR.150,TS   | 89-719282  |
| SA-HS,TYČ SPOJOVACIA,GR.200,HS   | 89-719480  |
| SA-HS,TYČ SPOJOVACIA,GR.250,HS   | 89-719497  |
| SA-HS,UZÁVER,STRED,TORX,TS,B1/20 | 89-711850  |

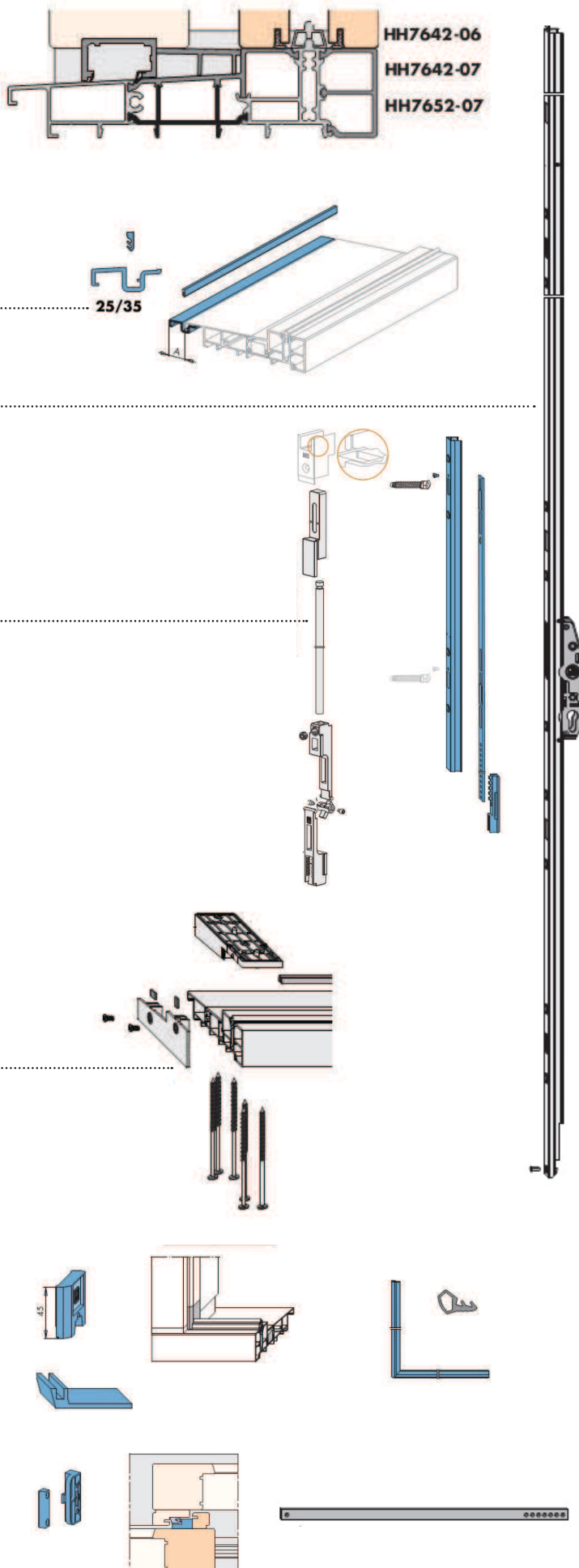

**SIEGENIA AUBI**  
SOLUTIONS INSIDE

# FS PORTAL

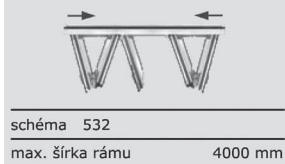
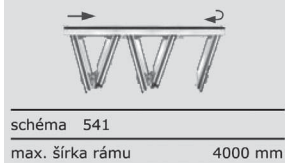
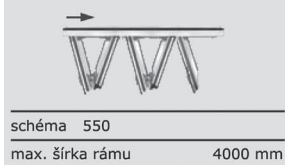
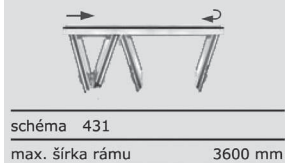
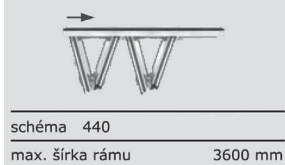
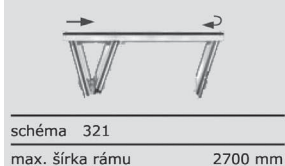
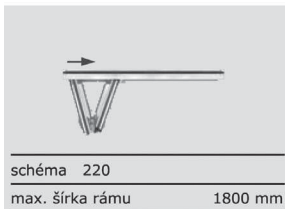

Profil FS

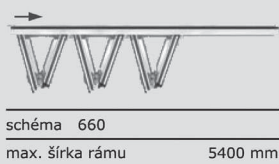
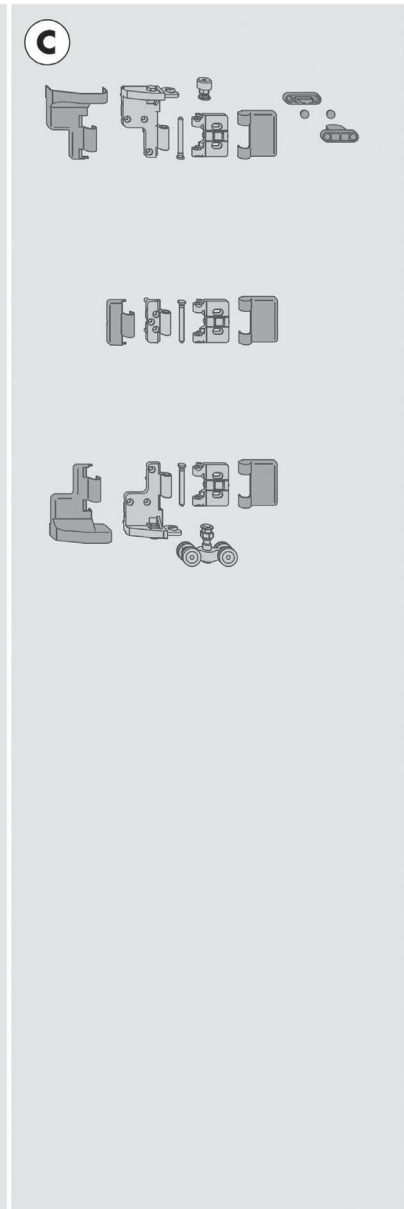
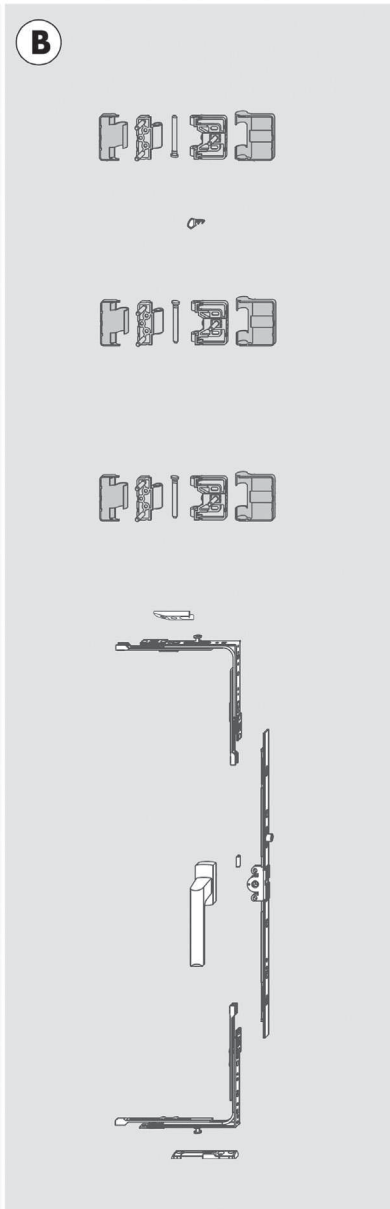
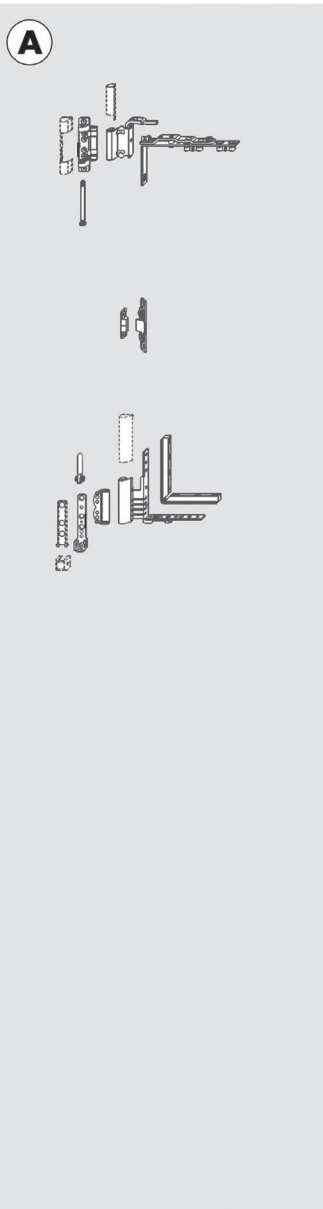
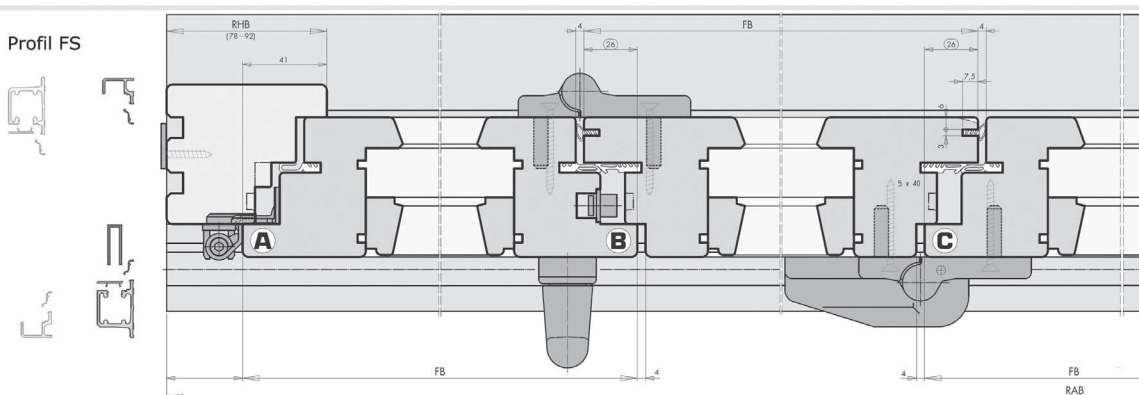

Medzné rozmery krídel

|                 |               |
|-----------------|---------------|
| šírka krídla    | 330 - 900 mm  |
| výška krídla    | 840 - 2360 mm |
| hmotnosť krídla | 80 kg         |

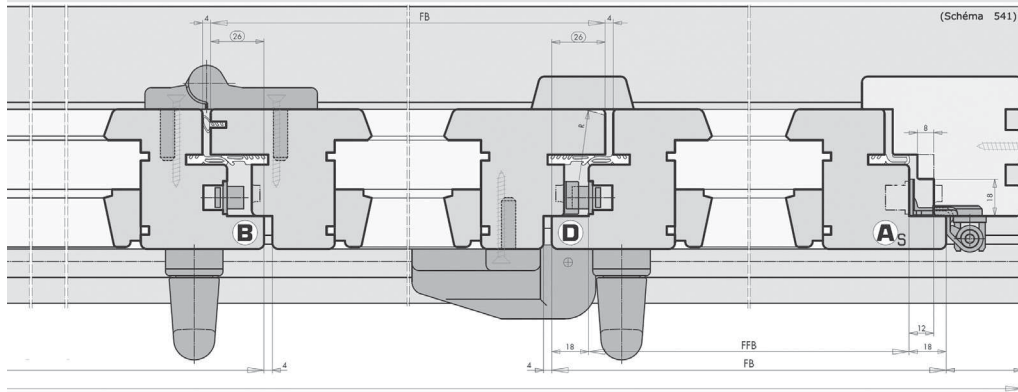

Bezbariérový prah FS

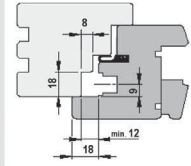
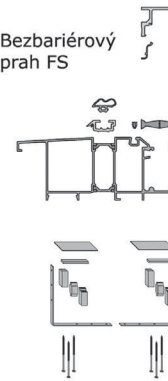

H 12/18-9

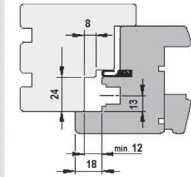

H 12/20-9

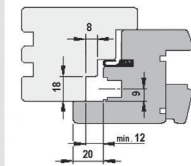

H 12/18-13

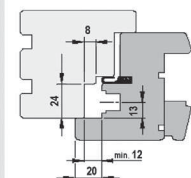

H 12/20-13

**D**

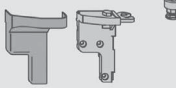

**E**

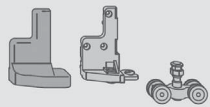

**F**



schéma 770  
max. šírka rámu 6300 mm







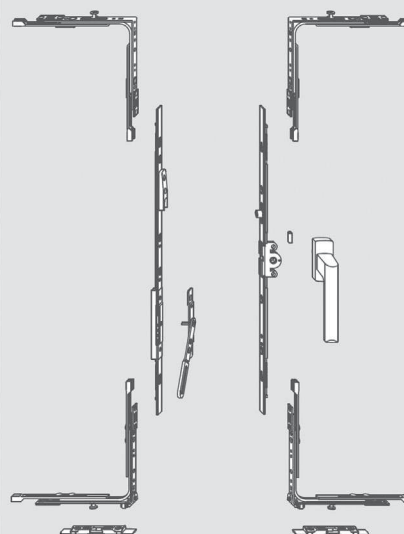





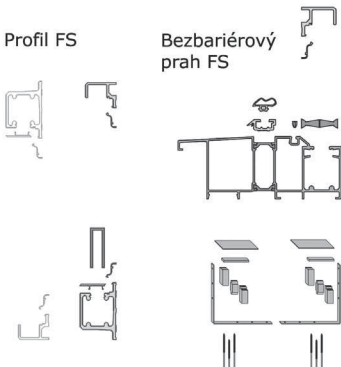
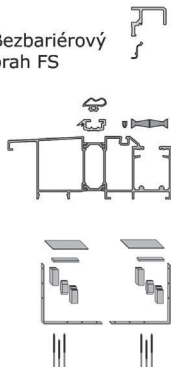
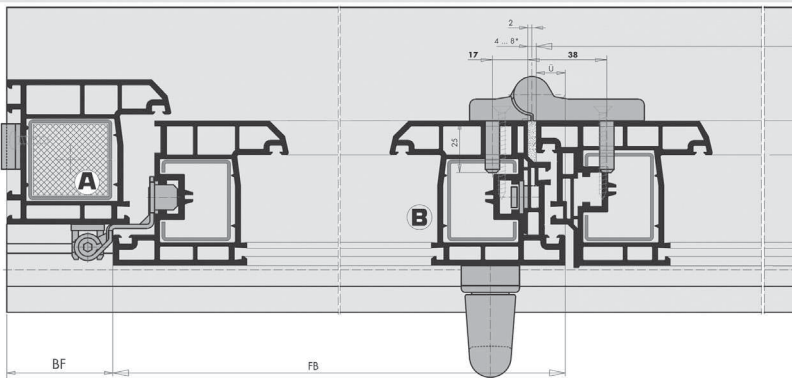

schéma 761  
max. šírka rámu 6300 mm

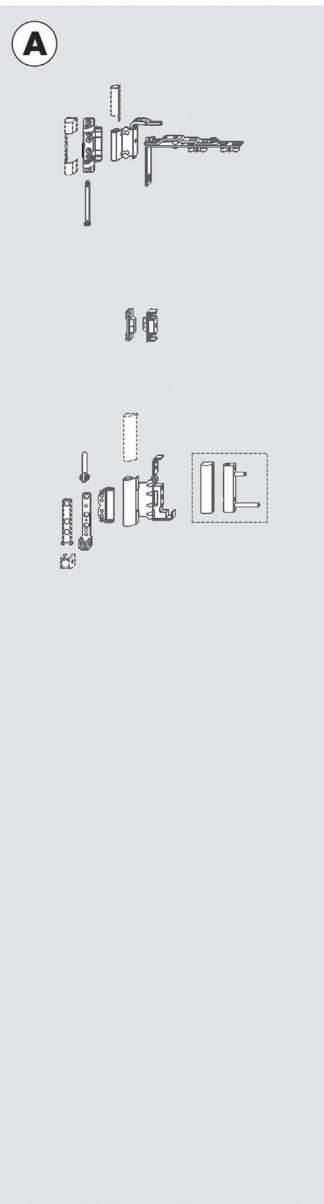

schéma 743  
max. šírka rámu 6300 mm

**SIEGENIA AUBI**<sup>®</sup>  
SOLUTIONS INSIDE

# FS PORTAL-KF

|  |   |  |  |
|--|---|--|--|
| <br>schéma 220<br>max. šírka rámu 1800 mm   | <b>Profil FS</b><br><br><b>Bezbariérový prah FS</b><br> |    |  |
| <br>schéma 330<br>max. šírka rámu 2700 mm   |   |  |  |
| <br>schéma 321<br>max. šírka rámu 2700 mm   |   |  |  |
| <br>schéma 440<br>max. šírka rámu 3600 mm |   |  |  |
| <br>schéma 431<br>max. šírka rámu 3600 mm |   |  |  |
| <br>schéma 550<br>max. šírka rámu 4000 mm |   |  |  |
| <br>schéma 541<br>max. šírka rámu 4000 mm |   |  |  |
| <br>schéma 532<br>max. šírka rámu 4000 mm |   |  | <b>A</b><br> |
| <br>schéma 660<br>max. šírka rámu 5400 mm | <br>schéma 651<br>max. šírka rámu 5400 mm   | <br>schéma 633<br>max. šírka rámu 5400 mm |  |

Medzné rozmery krídel

|                 |               |
|-----------------|---------------|
| šírka krídla    | 330 - 900 mm  |
| výška krídla    | 840 - 2360 mm |
| hmotnosť krídla | 80 kg         |

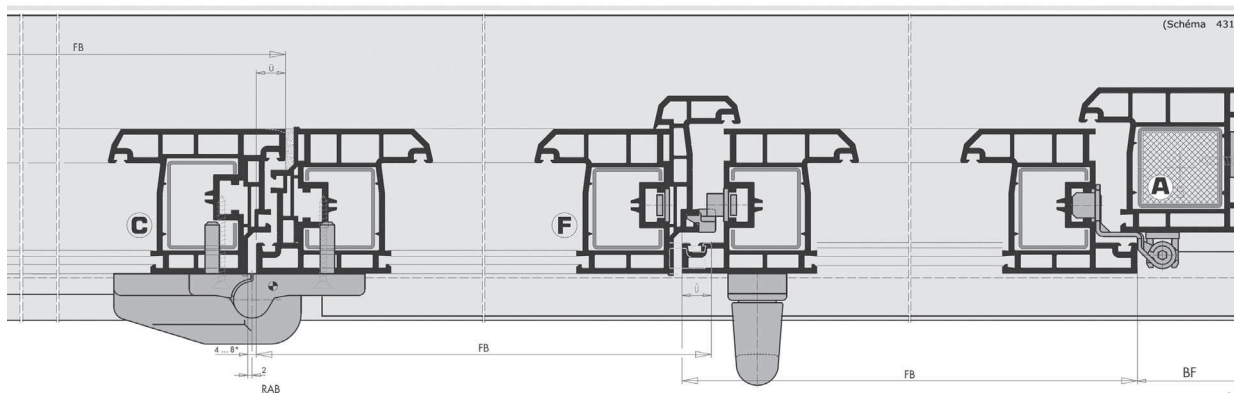
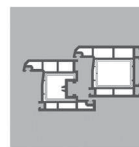

KF 12/20-9

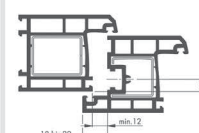

KF 12/20-13



schéma 770  
max. šírka rámu 6300 mm



schéma 761  
max. šírka rámu 6300 mm

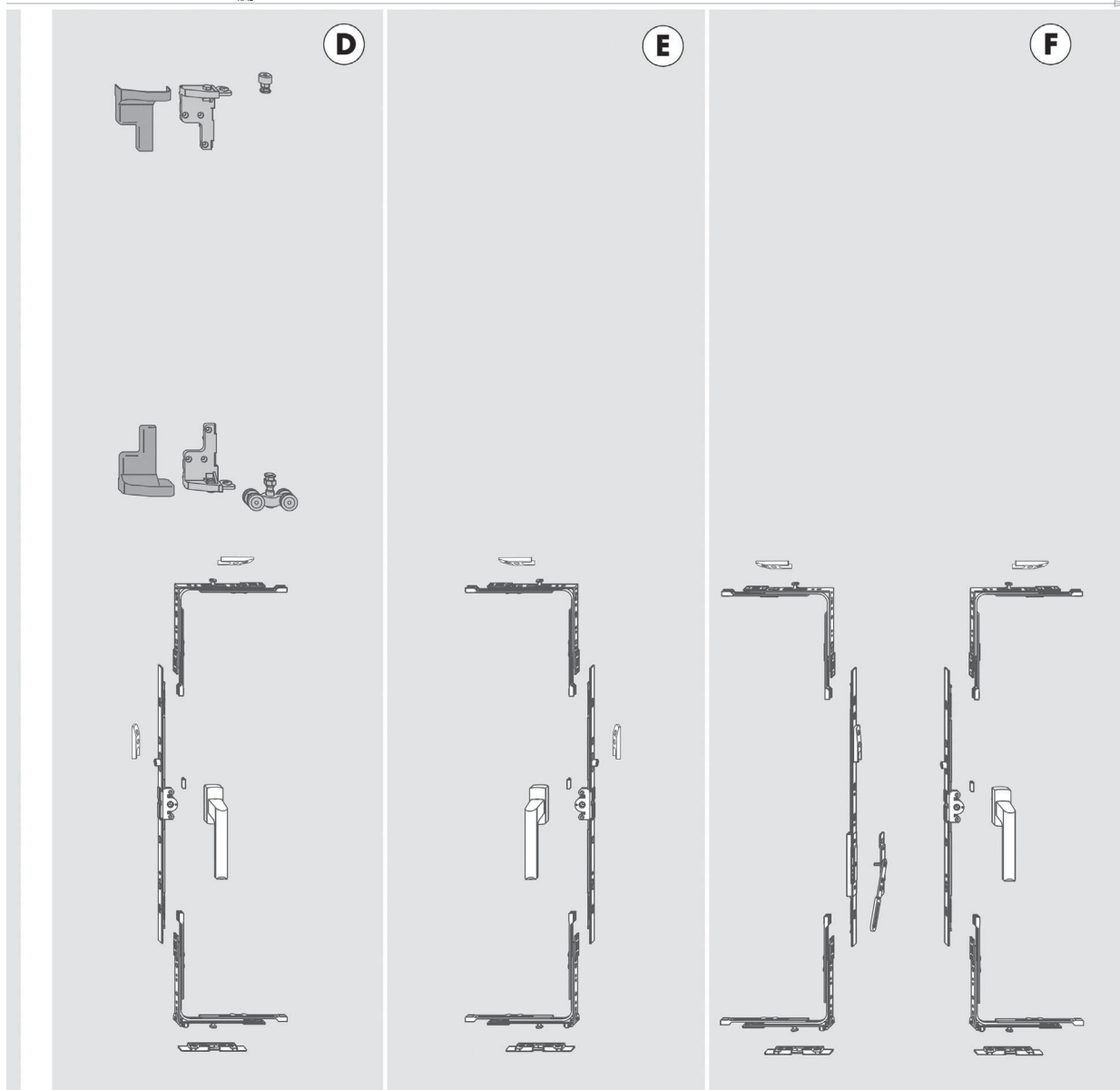

schéma 743  
max. šírka rámu 6300 mm

## 2.1 ZÁMKY NA VCHODOVÉ DVERE



### ZÁMOK AS

| Typ                                       | ŠTULP      | DORMAS | Obj. číslo |
|---|------------|--------|------------|
| <b>ZÁMOK AS 4100 (OVLÁDANÝ KĽUČKOU)</b>   |            |        |            |
| KFV-ZÁM,ROL,KK,AS-4100-F/16-55-8-ST,KOPI  | F16        | 55     | 75-3484655 |
| KFV-ZÁM,ROL,KK,AS-4100-F/16-45-8-ST,KOPI  | F16        | 45     | 75-3484654 |
| KFV-ZÁM,ROL,KK,AS-4100-F/16-40-8-ST,KOPI  | F16        | 40     | 75-3472482 |
| KFV-ZÁM,ROL,KK,AS-4100-F/16-35-8-ST,KOPI  | F16        | 35     | 75-3484653 |
| <b>ZÁMOK AS 8100 (OVLÁDANÝ KĽUČÍKOM)</b>  |            |        |            |
| KFV-ZÁM,ROL,GK,AS-8100-F/16-55-92-8-KOPI  | F16        | 55     | 75-3484650 |
| KFV-ZÁM,ROL,GK,AS-8100-F/16-45-92-8-KOPI  | F16        | 45     | 75-3484649 |
| KFV-ZÁM,ROL,GK,AS-8100-F/16-40-92-8-KOPI  | F16        | 40     | 75-3476858 |
| KFV-ZÁM,ROL,GK,AS-8100-F/16-35-92-8-KOPI  | F16        | 35     | 75-3473262 |
| <b>ZÁMOK AS2500Q (OVLÁDANÝ KĽUČÍKOM)</b>  |            |        |            |
| KFV-ZÁM,HAK,GK,AS2500QF/16-55-92-8-B001   | F16        | 55     | 75-3491441 |
| KFV-ZÁM,HAK,GK,AS2500QF/16-55-92-8-B298   | F16        | 55     | 75-3458794 |
| KFV-ZÁM,HAK,GK,AS2500QF/16-45-92-8-B001   | F16        | 45     | 75-3480125 |
| KFV-ZÁM,HAK,GK,AS2500QF/16-45-92-8-B298   | F16        | 45     | 75-3491444 |
| <b>AS 2500</b>                            |            |        |            |
| KFV-ZÁM,HAK,GK,AS-V2500-F/16-55-92-8V001  | F16        | 55     | 75-3443770 |
| <b>ZÁMOK AS2750Q (AKTÍVNY AUTOMAT)</b>    |            |        |            |
| KFV-ZÁM,AUT,GK,AS2750QU10/30-55-92-8-B001 | P 10X30X10 | 55     | 75-3491439 |
| KFV-ZÁM,AUT,GK,AS2750QF/16-55-92-8-B001   | F16        | 55     | 75-3491440 |
| KFV-ZÁM,AUT,GK,AS2750QF/16-55-92-8-B298   | F16        | 55     | 75-3491293 |
| KFV-ZÁM,AUT,GK,AS2750QF/16-45-92-8-B001   | F16        | 45     | 75-3489073 |
| KFV-ZÁM,AUT,GK,AS2750QF/16-45-92-8-B298   | F16        | 45     | 75-3489076 |
| KFV-ZÁM,AUT,GK,AS2750QF/16-35-92-8-B001   | F16        | 35     | 75-3468659 |
| <b>ZÁMOK AS3500Q (PASIŤVNY AUTOMAT)</b>   |            |        |            |
| KFV-ZÁM,AUT,AS-3500Q,U6/24-45-92-8-B298   | P 6X24X6   | 45     | 75-3482560 |
| KFV-ZÁM,AUT,AS-3500Q,U6/24-45-92-8-B003   | P 6X24X6   | 45     | 75-3483720 |
| KFV-ZÁM,AUT,AS-3500Q,U6/24-45-92-8-B001   | P 6X24X6   | 45     | 75-3483721 |
| KFV-ZÁM,AUT,AS-3500Q,U10/30-55-92-8-B001  | P 10X30X10 | 55     | 75-3491442 |
| KFV-ZÁM,AUT,AS-3500Q,F/16-55-92-8-B298    | F16        | 55     | 75-3482476 |
| KFV-ZÁM,AUT,AS-3500Q,F/16-55-92-8-B001    | F16        | 55     | 75-3482478 |
| KFV-ZÁM,AUT,AS-3500Q,F/16-45-92-8-B298    | F16        | 45     | 75-3482464 |
| KFV-ZÁM,AUT,AS-3500Q,F/16-45-92-8-B001    | F16        | 45     | 75-3482466 |
| KFV-ZÁM,AUT,AS-3500Q,F/16-35-92-8-B001    | F16        | 35     | 75-3482449 |

### ZÁMOK 49 (krátky)

| Typ                                    | Obj. číslo |
|--|------------|
| KFV-ZÁM,SOLO,RES49-PZW-F/16-45-92-8-31 | 75-3202757 |
| KFV-ZÁM,SOLO,RES49-PZW-F/16-35-92-8-31 | 75-3115979 |

| Typ                                    | Jazyček                              | Obj. číslo |
|--|--------------------------------------|------------|
| MEDZIKUS                               | KFV-ZÁM.MEDZIKUS,<br>ASS7033-F-16/31 | 75-3466534 |
| DOPLNKOVÝ<br>UZATVÁRACÍ BOD<br>(KOLÍK) | KFV-ZÁM.KOL.PREDLŽ.<br>V2300-F-16/31 | 75-3454796 |







### Štulpové krídlo

#### Predĺženie s uzatváracím bodom

| Predĺženie 400mm  | Dĺžka  | Výškový variant |
|---|--------|-----------------|
|  V7746 -230G | 400 mm | B001            |

#### Predĺženie bez uzatvárania

| Predĺženia 400 mm  | Predĺženia 300 mm  |
|--|--|
|  V7740 -230   |  V7730 -230   |
| Predĺženia 200 mm  | Predĺženia 100 mm  |
|  V7720 -230 |  V7710 -230 |

| Medzikus   | 200 mm |
|--|--------|
|  V7033 -230 |        |

#### Zakladný diel

| Zakladný diel |                      |
|---------------|----------------------|
| B 001         | pre štandardnu výšku |
| B560 -230G    | B 298<br>znižený     |

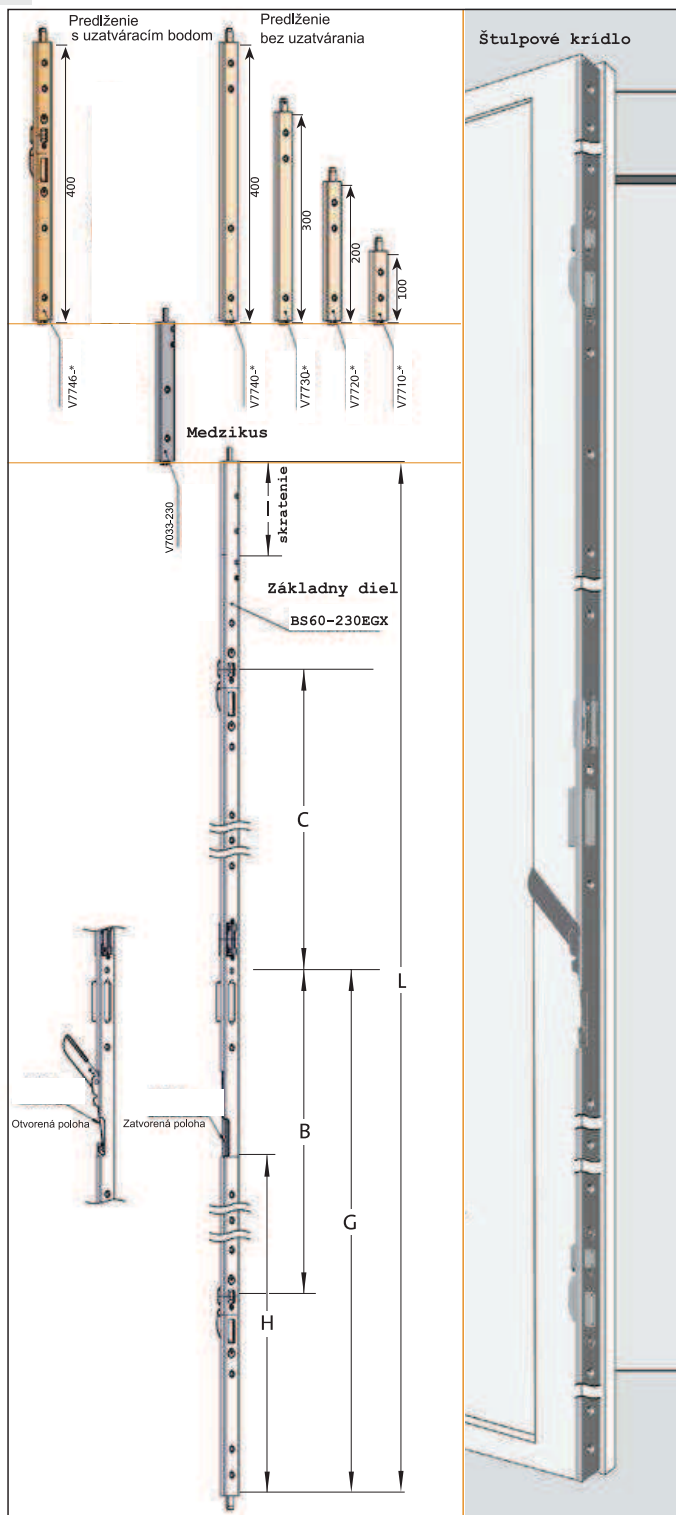

#### Rozmery dôležité pre zakovanie

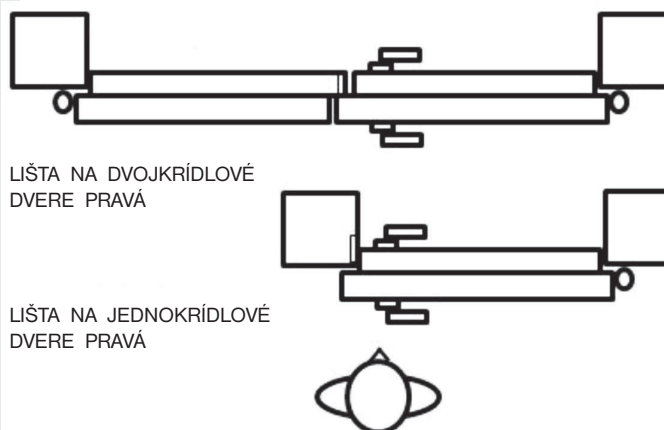
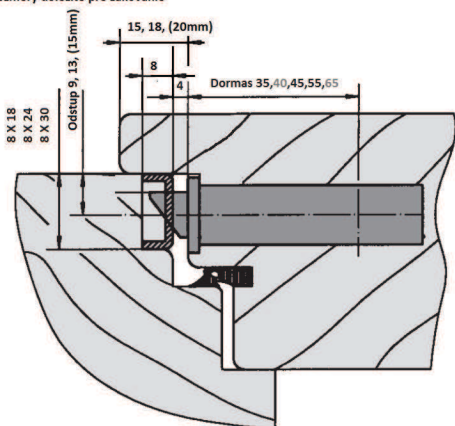

**ZÁMOK FUHR**

| Typ  | ŠTULP | DORMAS | Obj. číslo |
|--|-------|--------|------------|
| <b>ZÁMOK AS2600 (GENIUS)</b>               |       |        |            |
| KFV-ZÁM,ROL, KK, AS-4100-F/16-55-8-ST,KOPI | F16   | 55     | 75-3454564 |
| KFV-ZÁM,ROL, KK, AS-4100-F/16-45-8-ST,KOPI | F16   | 55     | 75-3453600 |

**OVLÁDANIE NA OTLAČOK PRSTA (Genius B)**

|  |                 |            |
|--|-----------------|------------|
| KFV-Q-GEN,FINGERPRINT+KÁBEL 0,75m        | SNÍMAČ OTLAČKOV | 75-3470833 |
| KFV-Q-GEN,TLAČÍTKO VNÚTORNÉ +KÁBEL 0,75m | TLAČÍTKO        | 75-3386310 |

**OTVÁRANIE INFRAČERVENÝM VYSIELAČOM (Genius B)**

|  |                      |            |
|--|----------------------|------------|
| KFV-Q-GEN,INFRA.VYSIELAČ,2-KANÁL         | VYSIELAČ NA KLÚČE    | 75-3328135 |
| KFV-Q-GEN,INFRA.PROGRAMCI KLÚČ           | INFRA. PROGRAM. KLÚČ | 75-3308687 |
| KFV-Q-GEN,INFRASNÍMAČ +KÁBEL 0,3m        | INFRASNÍMAČ          | 75-3388404 |
| KFV-Q-GEN,TLAČÍTKO VNÚTORNÉ +KÁBEL 0,75m | TLAČÍTKO             | 75-3386310 |

**OTVÁRANIE S RÁDIOVÝM VYSIELAČOM (Genius B+A)**

|  |                     |            |
|--|---------------------|------------|
| KFV-Q-GEN,RÁD.VYSIELAČ,2-KANÁL, SIVÝ     | VYSIELAČ NA KLÚČE   | 75-3377395 |
| KFV-Q-GEN,RÁD.PRIJÍMAČ,SÉRIA A           | PRIJÍMAČ NA OMIETKU | 75-3377393 |
| KFV-Q-GEN,TLAČÍTKO VNÚTORNÉ +KÁBEL 0,75m | TLAČÍTKO            | 75-3386310 |

**OTVÁRANIE MAGNETICKÝM TRANSPONDÉROM (Genius B+A)**

|  |                               |            |
|--|-------------------------------|------------|
| KFV-Q-GEN,MAGNT.TRANSPONDÉR              | KLÚČENKA                      | 75-3406519 |
| KFV-Q-GEN,PROGRAMOVANIE TRANSP           | NA OMIETKU PROGRAMOVACI MODUL | 75-3406512 |
| KFV-Q-GEN,ČÍTAČKA MAG.KODU               | ČÍTAČKA                       | 75-3406518 |
| KFV-Q-GEN,TLAČÍTKO VNÚTORNÉ +KÁBEL 0,75m | TLAČÍTKO                      | 75-3386310 |

**PRÍSLUŠENSTVO GENIUS**

|                                       |            |
|---------------------------------------|------------|
| KFV-Q-GEN,PRECHODKA,180°,20MM         | 75-3458247 |
| KFV-Q-GEN,UKONČENIE PRECHOD,20MM      | 75-3458254 |
| KFV-Q-GEN,MAGNET NALEP,2MM,KRUH       | 75-3381675 |
| KFV-Q-GEN,KÁBEL+SPOJKA,F,KRÍD.ČASŤ,4M | 75-3381527 |
| KFV-Q-GEN,KÁBEL+SPOJKA,B,RÁM.ČASŤ,8M  | 75-3308725 |
| KFV-Q-GEN,KÁBEL,E,3-ŽILOVÝ,1M         | 75-3378077 |
| KFV-Q-GEN,ADAPTÉR,230/24              | 75-3470513 |

**SKÚŠAČKA VŠETKÝCH MOŽNOSTÍ OTVÁRANIA**

|                          |            |
|--------------------------|------------|
| KFV-Q-GEN,ADAPTÉR TESTRA | 75-3477319 |
| KFV-Q-GEN,TESTER,230V    | 75-3484544 |

**PROTIKUS KRÁTKY KOLÍK / HÁK**

| Typ             | Na profil | Orientacia / šírka protikusu | Odstup / vôľa | Obj. číslo |
|-----------------|-----------|------------------------------|---------------|------------|
| 3625-733-2Q/31R | Plast     | PRAVÝ                        | Gealan / 2kr  | 75-3481318 |
| 3625-733-2Q/31L | Plast     | ĽAVÝ                         | Gealan / 2kr  | 75-3481317 |
| 3625-328Q-31R   | Plast     | PRAVÝ                        | Gealan / 1kr  | 75-3477105 |
| 3625-328Q-31L   | Plast     | ĽAVÝ                         | Gealan / 1kr  | 75-3477104 |
| 3625-08-24Q/31  | Drevo     | L / P - 24mm                 | 13 / 12       | 75-3478728 |
| 3617-580-1G/31R | Drevo     | PRAVÝ                        | 13 / 4        | 75-3329805 |
| 3617-580-1G/31L | Drevo     | ĽAVÝ                         | 13 / 4        | 75-3329804 |
| 3625-512/31     | Drevo     | L / P - 18mm                 | 9 / 12        | 75-3221513 |
| 3625-06-24Q/31  | Hliník    | L / P                        |               | 75-3477535 |

**PROTIKUS K ZÁSTRČI**

| Typ                | Na profil | šírka protikusu   | Odstup / vôľa  | Obj. číslo |
|--------------------|-----------|-------------------|----------------|------------|
| 2325-06,10x24x10   | Drevo     | 24mm              | 13 / 12        | 75-3483296 |
| 2315-530G 10x30x10 | Drevo     | 30mm              | 15(13*) / 12   | 75-3276745 |
| 2317-580           | Drevo     | Na zafrézovanie   | 13 / 4         | 75-3333396 |
| 2319-504V/31-A     | Drevo     | 18mm na zafr.     | 9 / 4          | 75-3319510 |
| 2319-512V/31       | Drevo     | 18mm              | 9 / 12         | 75-3331149 |
| 8028-4V            | Drevo     | PUZDRO na zafréz. | 15(13*)/4 (12) | 75-3473961 |
| ZAFREZ,2300-08-20  | Drevo     | Na zafrézovanie   | 15(13*)/4 (12) | 75-3345818 |
| 2325-948G/31       | Plast     |                   | Gealan         | 75-3375459 |
| 2325-06-24G        | Hliník    |                   |                | 75-3483296 |

**PROTIKUS KRÁTKY HLAVNÝ**

| Typ            | Na profil | Orientacia / šírka protikusu | Odstup / vôľa | Obj. číslo |
|----------------|-----------|------------------------------|---------------|------------|
| 25-733-2EH/31R | Plast     | PRAVÝ                        | Gealan / 2kr  | 75-3482334 |
| 25-733-2EH/31L | Plast     | ĽAVÝ                         | Gealan / 2kr  | 75-3482332 |
| 25-328-1EH/31R | Plast     | PRAVÝ                        | Gealan / 1kr  | 75-3481400 |
| 25-328-1EH/31L | Plast     | ĽAVÝ                         | Gealan / 1kr  | 75-3481401 |
| 19-504V/31     | Drevo     | L / P - 18mm                 | 9 / 4         | 75-3216471 |
| 19-512V/31     | Drevo     | L / P - 18mm                 | 9 / 12        | 75-3355916 |
| 17-580-1E/31R  | Drevo     | PRAVÝ                        | 13 / 4        | 75-3351110 |
| 17-580-1E/31L  | Drevo     | ĽAVÝ                         | 13 / 4        | 75-3351109 |
| 25-08-24ERH    | Drevo     | PRAVÝ - 24mm                 | 13 / 12       | 75-3478724 |
| 25-08-24ERH    | Drevo     | ĽAVÝ - 24mm                  | 13 / 12       | 75-3478725 |
| 25-06-24ERH    | Hliník    | PRAVÝ                        |               | 75-3477658 |
| 25-06-24ERH    | Hliník    | ĽAVÝ                         |               | 75-3477657 |

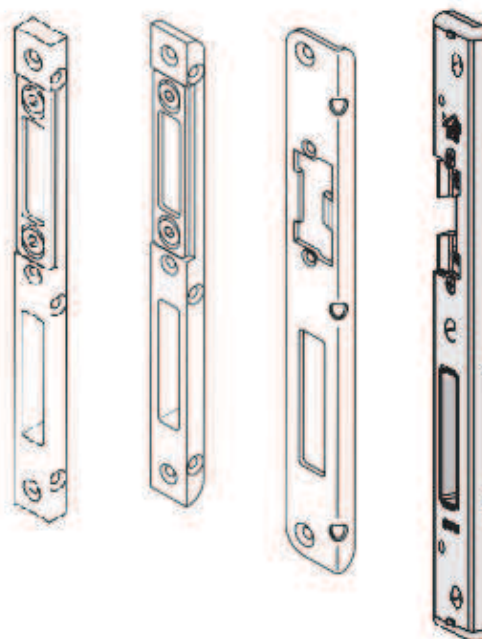
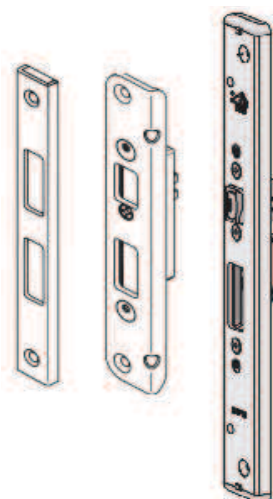

## 2.2 PROTIPLECHY NA VCHODOVÉ DVERE

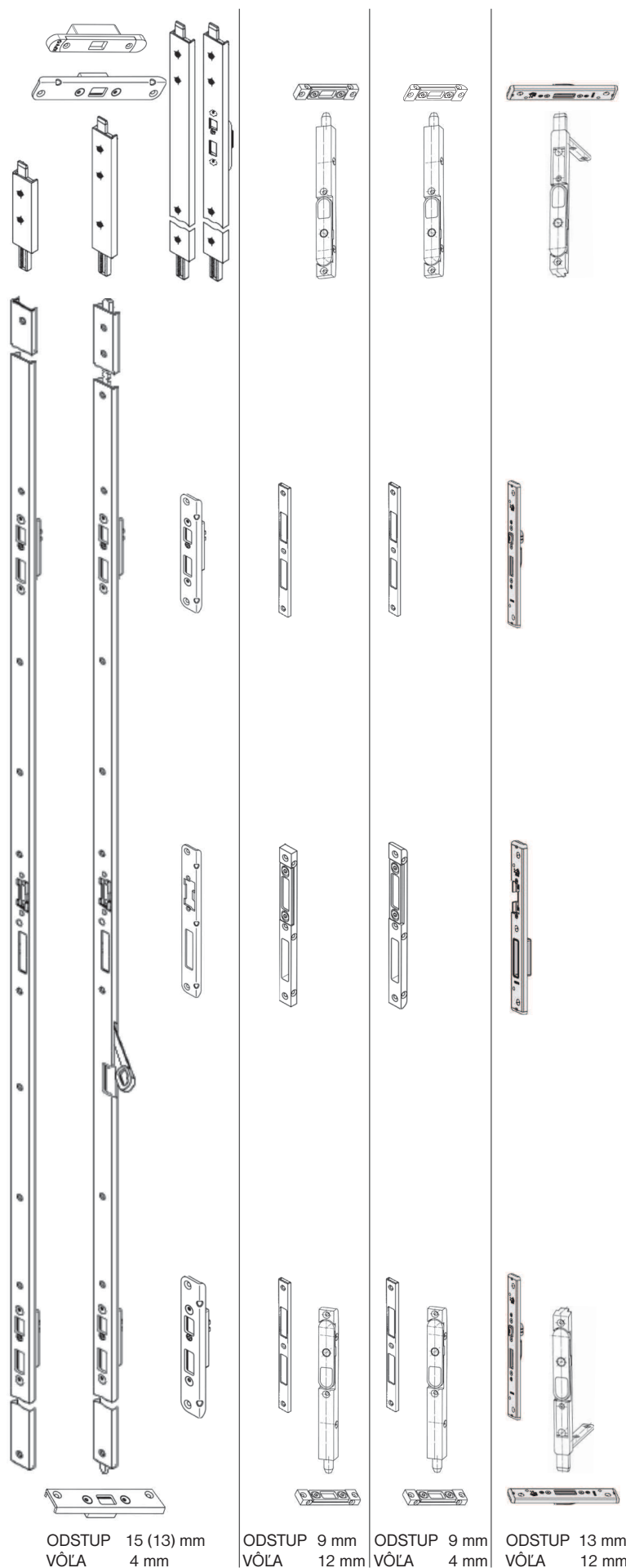

### LIŠTA JEDNOKRÍDLOVÁ

| Typ                          | Odstup / vôľa | Obj. číslo |
|------------------------------|---------------|------------|
| PRAVÁ, 24/6, BD25-2-0624EG   | 13 / 4        | 75-3478552 |
| ĽAVÁ, 24/6, BD25-2-0624EG    | 13 / 4        | 75-3478553 |
| ĽAVÁ/PRAVÁ 18/8, BD25-2-512V | 9 / 4         | 75-3443327 |
| PRAVÁ, 30/10, BD25-2-230EG   | 15 (13*) / 4  | 75-3478302 |
| ĽAVA, 30/10, BD25-2-230EG    | 15 (13*) / 4  | 75-3478303 |

### LIŠTA DVOJKRÍDLOVÁ

| Typ                        | Odstup / vôľa | Obj. číslo |
|----------------------------|---------------|------------|
| PRAVÁ, 8/30/10, BS60-230EG | 15 (13*) / 4  | 75-3478448 |
| ĽAVA, 8/30/10, BS60-230EG  | 15 (13*) / 4  | 75-3478449 |

### LIŠTA DVOJKRÍDLOVÁ (znižena)

| Typ                        | Odstup / vôľa | Obj. číslo |
|----------------------------|---------------|------------|
| PRAVÁ, 8/30/10, BS60-230EG | 15 (13*) / 4  | 89-3478968 |
| ĽAVA, 8/30/10, BS60-230EG  | 15 (13*) / 4  | 89-3478967 |

\* varianta zámku s 2mm ustúpeným jazýčkom

\*\* podľa dĺžky ukončovacieho kusu

### UKONČENIE LIŠTY 400 / K+ H

| Typ                      | Odstup / vôľa | Obj. číslo |
|--------------------------|---------------|------------|
| PRAVÁ, 8/30/10V7746-230G | 15 (13*) / 4  | 75-3483352 |
| ĽAVÁ, 8/30/10V7746-230G  | 15 (13*) / 4  | 75-3483351 |

### UKONČENIE LIŠTY 400

| Typ                  | Odstup / vôľa | Obj. číslo |
|----------------------|---------------|------------|
| PRAVÁ, V7740-230/31R | 15 (13*) / 4  | 75-3449139 |
| ĽAVÁ, V7740-230/31L  | 15 (13*) / 4  | 75-3449138 |

### UKONČENIE LIŠTY 300

| Typ                  | Odstup / vôľa | Obj. číslo |
|----------------------|---------------|------------|
| PRAVÁ, V7730-230/31P | 15 (13*) / 4  | 75-3468095 |
| ĽAVÁ, V7730-230/31L  | 15 (13*) / 4  | 75-3468093 |

### UKONČENIE LIŠTY 300

| Typ                  | Odstup / vôľa | Obj. číslo |
|----------------------|---------------|------------|
| PRAVÁ, V7720-230/31P | 15 (13*) / 4  | 75-3449143 |
| ĽAVÁ, V7720-230/31L  | 15 (13*) / 4  | 75-3449142 |

### UKONČENIE LIŠTY 100

| Typ                  | Odstup / vôľa | Obj. číslo |
|----------------------|---------------|------------|
| PRAVÁ, V7710-230/31P | 15 (13*) / 4  | 75-3449144 |
| ĽAVÁ, V7710-230/31L  | 15 (13*) / 4  | 75-3449145 |

### MEDZIKUS

| Typ                | Odstup / vôľa | Obj. číslo |
|--------------------|---------------|------------|
| PRAVÁ, V7033-230/R | 15 (13*) / 4  | 75-3449137 |
| ĽAVÁ, V7033-230/L  | 15 (13*) / 4  | 75-3449136 |

**DOPLNKY**

| Typ   | Obj. číslo |
|---|------------|
| KFV-Q, UKONČENIE Nr.170/16mm/ČIERNA           | 75-3457250 |
| KFV-Q, KLÚČ MONTÁŽNY, Nr.8200                 | 75-3466845 |
| KFV-Q-ZÁM, REDUKCIA, 10/8, NA ŠTVORHRAN       | 75-3468925 |
| KFV-Q-ZÁM, 2750, STRELKA USTUP. 2mm, D55      | 75-3338139 |
| KFV-Q-ZÁM, 2500, STRELKA NORMAL, D55          | 75-3200325 |
| KFV-Q-PP-VÝMENNÝ KUS, 116-08-5/31             | 75-3466981 |
| KFV-Q-PP-VÝMENNÝ KUS, 116-05-5/31             | 75-3993699 |
| KFV-Q-PP-KRYTKA, PLAST, 25-30-2/87-O-X        | 75-3465923 |
| KFV-Q-PP-KRYTKA, PLAST, 25-20-2/87            | 75-3976479 |
| KFV-Q, PREPÍNAČ DEŇ-NOC, NA AS 3500           | 75-3485984 |
| KFV-PP, Q, MAGNET DO PROTIPLECHU              | 75-3482036 |
| KFV-Q-PP-MECH, VRÁTNIK 115-A/31               | 75-3465936 |
| KFV-Q-PP-DORCAS, 6-12V, P/L, ARET, DEL. STREL | 75-0000116 |
| KFV-Q-PP-PRECHODKA KÁBL, 2KONTAKT -ZÁFREZ     | 75-0000100 |
| KFV-Q-PP-PRECHODKA KÁBL, 2KONTAKT, TMAVÁ      | 75-0000002 |
| KFV-Q-MOTOR F1600 /CA (AS3500Q)               | 75-3482257 |
| KFV-Q-MOTOR F1600 /CF (AS3500Q)               | 75-3482258 |

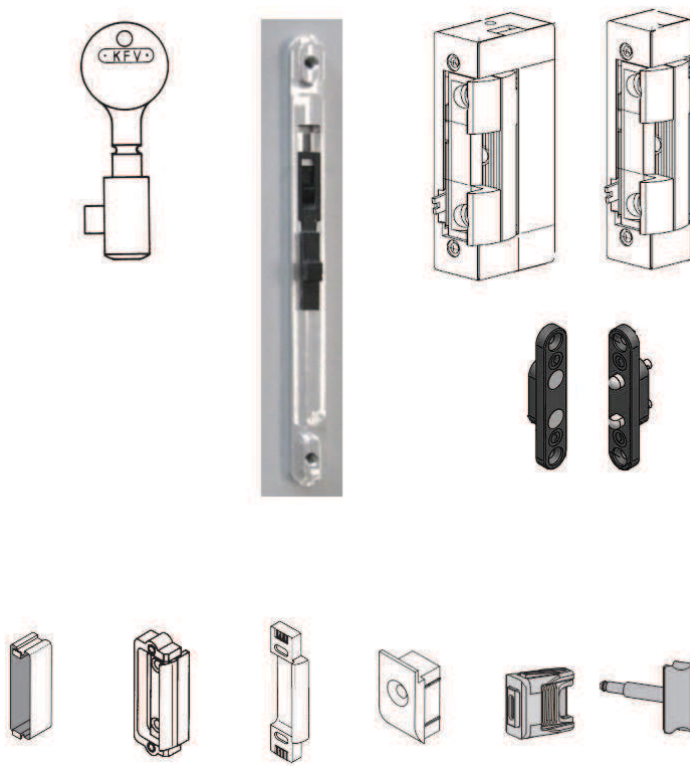

**PROTIKUS K ZÁSTRČI**

| Typ                             | profil          | Obj. číslo |
|---------------------------------|-----------------|------------|
| 8037, EURODRAŽ. KRÁT. 145-160MM | EURODRAŽKA      | 75-3318916 |
| 8034, EUROFALC, 185-200MM       | EUROFALC 18mm   | 75-3297582 |
| 8033, EURONUT 145-160MM         | EURONUT 7/8/4   | 75-3254248 |
| 8032, EURODRAŽ. DLHÁ, 180-200MM | EURODRAŽKA      | 75-3228000 |
| 8030, NA ZAFRÉZOVANIE, 185MM    | NA ZAFRÉZOVANIE | 75-3128260 |

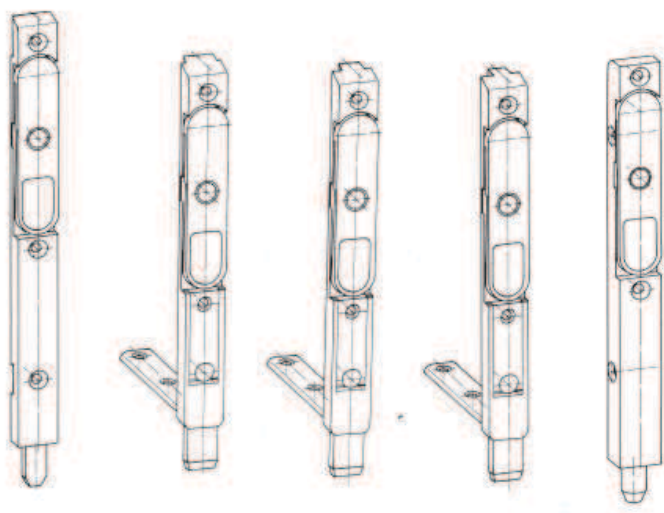

8034      8037      8032      8033      8030

## 2.3 ZÁVESY NA VCHODOVÉ DVERE

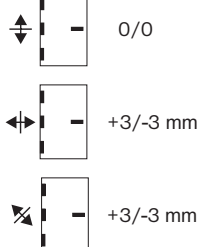
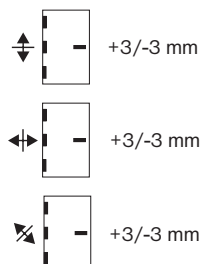
**NASTAVITELNOSŤ**

**NASTAVITELNOSŤ**

**Bronz**
**F1-Strieborna**
**F9-Hneda**
**Biela**
**ZÁVES BAKA 2000 2D**  
na vchodové drevené dvere

| Typ                       | Nosnosť | Povrchová úprava | Obj. číslo  |
|---------------------------|---------|------------------|-------------|
| BAKA 2010 2D (F-18,T-nie) | 120 kg  | Zinok            | 75-50808121 |

**ZÁVES BAKA PROTECT 3D**  
na vchodové drevené dvere

| Typ                               | Nosnosť | Povrch. úprava | Obj. číslo  |
|-----------------------------------|---------|----------------|-------------|
| BAKA,4010,3D (F-18,T-NIE)         | 160 kg  | Zinok          | 75-50808200 |
| BAKA,4010,3D MSTS (F-18,T-NIE)    | 160 kg  | Zinok          | 75-50808210 |
| BAKA,4010,3D,FD (F-18,T-18)       | 160 kg  | Zinok          | 75-50808220 |
| BAKA,4010,3D,FD, MSTS (F-18,T-18) | 160 kg  | Zinok          | 75-50808230 |
| BAKA,4030,3D,FD (F-20,T-10)       | 160 kg  | Zinok          | 75-50808260 |
| BAKA,4030,3D,FD,MSTS (F-20,T-10)  | 160 kg  | Zinok          | 75-50808270 |
| BAKA,4060,3D,FD (F-18,T-4,5)      | 160 kg  | Zinok          | 75-50808560 |

**KRYTKA NA BAKA PROTECT 3D**

| Povrchová úprava         | Obj. číslo  |
|--------------------------|-------------|
| KRYTKA 4000,3D, R9016    | 75-51006800 |
| KRYTKA 4000,3D, BRONZ    | 75-51006801 |
| KRYTKA 4000,3D,H9, HNEDÁ | 75-51006809 |
| KRYTKA 4000,3D, CR       | 75-51006885 |

**KRYTKA OTVOROV V RÁME**

| Povrchová úprava               | Obj. číslo  |
|--------------------------------|-------------|
| KRYTKA DLHÁ,TERRA,R8028, HNEDÁ | 75-11398028 |
| KRYTKA DLHÁ,BÉŽOVÁ, R1011      | 75-11398077 |
| KRYTKA DLHÁ, R9016             | 75-11399016 |

**PRÍSLUŠENSTVO PRE ZÁVES BAKA 4000 3D**

| Typ                                  | Obj. číslo  |
|--------------------------------------|-------------|
| SS-ŠABLÓNA, BAKA 4000,RÁM            | 75-52510240 |
| SS-ŠABLÓNA, BAKA 4000,RÁM-ROZŠÍRENIE | 75-52510320 |
| SS-ŠABLÓNA, BAKA 4000,KRÍDLO         | 75-52510420 |

**ZÁVES KT-N6R**  
na vchodové plastové dvere



| Typ    | Nosnosť | Rozsah   | Povrch. úprava | Obj. číslo  |
|--------|---------|----------|----------------|-------------|
| KT-N6R | 140 kg  | 15-20 mm | RAL 8077       | 75-42050000 |
| KT-N6R | 140 kg  | 15-20 mm | RAL 9016       | 75-42090000 |
| KT-N6R | 140 kg  | 18-23 mm | RAL 9016       | 75-43090000 |

**Povrchová úprava:**

RAL 8077 - hnedá tmavá  
RAL 8003 - hnedá svetlá (hlinená)  
RAL 9016 - biela  
RAL 9006 - strieborná perleťová svetlá  
RAL 1036 - zlatá perleťová

**ZÁVES KT-V6R FIX**  
na vchodové plastové dvere



| Typ    | Nosnosť | Rozsah   | Povrch. úprava | Obj. číslo  |
|--------|---------|----------|----------------|-------------|
| KT-V6R | 140 kg  | 15-20 mm | RAL 8077       | 75-37058077 |
| KT-V6R | 140 kg  | 15-20 mm | RAL 9016       | 75-37069016 |
| KT-V6R | 140 kg  | 15-20 mm | RAL 1036       | 75-37091036 |

**ZÁVES SIKU 3D**  
na vchodové plastové dvere



| Typ   | Nosnosť | Rozsah   | Povrch. úprava | Obj. číslo  |
|-------|---------|----------|----------------|-------------|
| K3035 | 120 kg  | 15-19 mm | RAL 8077       | 75-30303589 |
| K3035 | 120 kg  | 15-19 mm | RAL 8003       | 75-30303583 |
| K3035 | 120 kg  | 15-19 mm | RAL 9016       | 75-30303596 |

**ZÁVES TB 4-2**  
na vchodové plastové dvere



| Typ    | Nosnosť | Šírkový variant | Povrch. úprava | Obj. číslo  |
|--------|---------|-----------------|----------------|-------------|
| TB 4-2 | 180 kg  | 65mm            | EV1            | 75-90110000 |
| TB 4-2 | 180 kg  | 65mm            | RAL1036        | 75-90191036 |
| TB 4-2 | 180 kg  | 91,5mm          | EV1            | 75-90510000 |
| TB 4-2 | 180 kg  | 91,5mm          | RAL1036        | 75-90591036 |



**NASTAVITELNOSŤ**

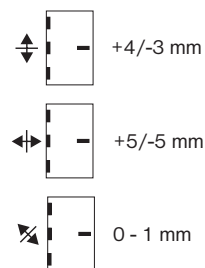

**NASTAVITELNOSŤ**

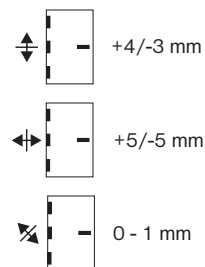

**NASTAVITELNOSŤ**

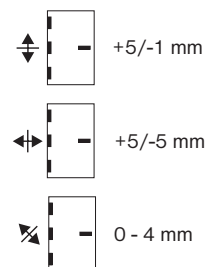

|      |         |            |
|------|---------|------------|
| 18   | 44,5 mm | = 62,5 mm  |
| 18   | 56 mm   | = 74 mm    |
| 20,5 | 44,5 mm | = 65mm     |
| 20,5 | 56 mm   | = 76,5 mm  |
| 18   | 62,5 mm | = 80,5 mm  |
| 20,5 | 62,5 mm | = 83 mm    |
| 41,5 | 44,5 mm | = 86 mm    |
| 41,5 | 56 mm   | = 97,5 mm  |
| 41,5 | 62,5 mm | = 104 mm   |
| 47   | 44,5 mm | = 91,5mm   |
| 47   | 56 mm   | = 103 mm   |
| 47   | 62,5 mm | = 109,5 mm |



**NASTAVITELNOSŤ**

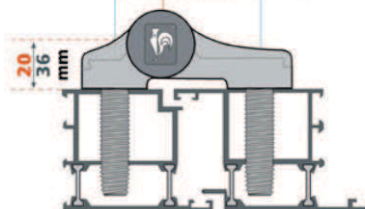
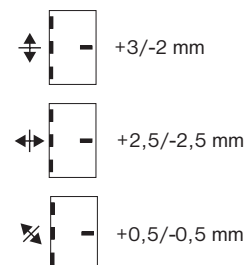

### 3.1 KLUČKY NA OKNÁ

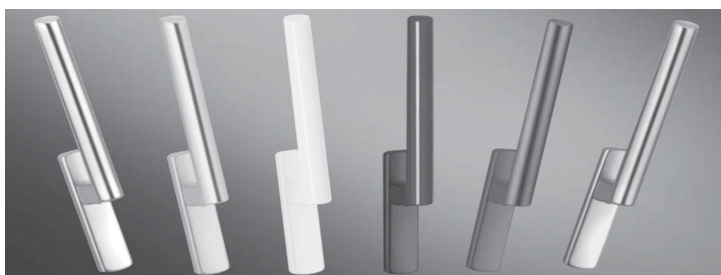

#### KLUČKA OKENNÁ SI-LINE FAVORIT



| Typ                    | Povrch. úprava     | Obj. číslo |
|------------------------|--------------------|------------|
| SI-line Favorit okenná | Biela              | 89-844052  |
| SI-line Favorit okenná | Bronz tmavý C33    | 89-849712  |
| SI-line Favorit okenná | Strieborná EV1     | 89-252314  |
| SI-line Favorit okenná | Titan matný svetlý | 89-869079  |
| SI-line Favorit okenná | Hnedá              | 89-844069  |

#### KLUČKA SI-LINE FAVORIT PSK<sup>plus</sup> 160



| Typ                                     | Povrch. úprava     | Obj. číslo |
|---|--------------------|------------|
| SI-line Favorit PSK <sup>plus</sup> 160 | Biela              | 89-875926  |
| SI-line Favorit PSK <sup>plus</sup> 160 | Bronz tmavý C33    | 89-875940  |
| SI-line Favorit PSK <sup>plus</sup> 160 | Strieborná EV1     | 89-875902  |
| SI-line Favorit PSK <sup>plus</sup> 160 | Titan matný svetlý | 89-884744  |
| SI-line Favorit PSK <sup>plus</sup> 160 | Hnedá              | 89-895689  |

#### KLUČKA SI-LINE FAVORIT PSK<sup>plus</sup> 200 Z



| Typ                             | Povrch. úprava     | Obj. číslo |
|---------------------------------|--------------------|------------|
| PSK <sup>plus</sup> 200 Z ľavá  | Biela              | 89-296325  |
| PSK <sup>plus</sup> 200 Z pravá | Biela              | 89-296271  |
| PSK <sup>plus</sup> 200 Z ľavá  | Bronz tmavý C33    | 89-296349  |
| PSK <sup>plus</sup> 200 Z pravá | Bronz tmavý C33    | 89-296295  |
| PSK <sup>plus</sup> 200 Z ľavá  | Strieborná EV1     | 89-296301  |
| PSK <sup>plus</sup> 200 Z pravá | Strieborná EV1     | 89-296257  |
| PSK <sup>plus</sup> 200 Z ľavá  | Hnedá              | 89-297803  |
| PSK <sup>plus</sup> 200 Z pravá | Hnedá              | 89-297797  |
| PSK <sup>plus</sup> 200 Z ľavá  | Titan matný svetlý | 89-296333  |
| PSK <sup>plus</sup> 200 Z pravá | Titan matný svetlý | 89-296323  |

#### KLUČKA VNUTORNÁ HS-300 (s prekrytím vložky)

| Typ                             | Povrch. úprava     | Obj. číslo |
|---------------------------------|--------------------|------------|
| SA-HS,KL,PHIB0050025010,SKLOPNÁ | EV1 strieborná     | 89-405510  |
| SA-HS,KL,PMHB0010-502011        | Biela              | 89-329474  |
| SA-HS,KL,PMHB0010-512011        | Hnedá              | 89-151201  |
| SA-HS,KL,PMHB0010-524011        | EV1 strieborná     | 89-524011  |
| SA-HS,KL,PMHB0010-530011        | Bronz tmavý C33    | 89-151203  |
| SA-HS,KL,PMHB0010-534011        | Titan matný svetlý | 89-530011  |
| SA-HS,KL,PMHB0010-5H001         | Bronz F4           | 89-151204  |

#### KLUČKA VNUTORNÁ HS 300(krytka na PZ)

| Typ                           | Povrch. úprava     | Obj. číslo |
|-------------------------------|--------------------|------------|
| SA-HS,KL,PMHB0040-502011,PZ-A | Biela              | 89-329210  |
| SA-HS,KL,PMHB0040-512011,PZ-A | Hnedá              | 89-512011  |
| SA-HS,KL,PMHB0040-524011,PZ-A | EV1 strieborná     | 89-329573  |
| SA-HS,KL,PMHB0040-530011,PZ-A | Bronz tmavý C33    | 89-530010  |
| SA-HS,KL,PMHB0040-534011,PZ-A | Titan matný svetlý | 89-534010  |
| SA-HS,KL,PMHB0040-5H0011,PZ-A | Bronz F4           | 89-333067  |

#### KLUČKA VONKAJŠIA HS 300 (s dlhým štvorhranom)

| Typ                                | Povrch. úprava     | Obj. číslo |
|------------------------------------|--------------------|------------|
| SA-HS,KL,PMHB0050-502011,PZ-I,DLHA | Biela              | 89-329689  |
| SA-HS,KL,PMHB0050-512011,PZ-I,DLHÁ | Hnedá              | 89-251201  |
| SA-HS,KL,PMHB0050-524011,PZ-I,DLHÁ | EV1 strieborná     | 89-343235  |
| SA-HS,KL,PMHB0050-530011,PZ-I,DLHÁ | Bronz tmavý C33    | 89-343236  |
| SA-HS,KL,PMHB0050-534011,PZ-I,DLHA | Titan matný svetlý | 89-329690  |
| SA-HS,KL,PMHB0050-5H0011,PZ-I,DLHÁ | Bronz F4           | 89-333065  |



**KLUČKA SKLOPNÁ**



| Typ                           | Povrch. úprava | Obj. číslo |
|-------------------------------|----------------|------------|
| KLUČKA ZAFREZOVANÁ SKLOPNÁ,42 | EV1 Strieborná | 89-888575  |

**KLUČKA GLOBE (35mm štvorhran)**



| Typ                     | Povrch. úprava | Obj. číslo |
|-------------------------|----------------|------------|
| SA-AF,KLUČKA GLOBE,35mm | Biela R90016   | 89-890653  |
| SA-AF,KLUČKA GLOBE,35mm | Strieborna EV1 | 89-890570  |
| SA-AF,KLUČKA GLOBE,35mm | Bronz F4       | 89-890332  |
| SA-AF,KLUČKA GLOBE,35mm | Titan mat F9   | 89-890318  |

**KLUČKA GLOBE (na terasové balkónové dvere)**



| Typ                      | Povrch. úprava | Rozsah | Obj. číslo |
|--------------------------|----------------|--------|------------|
| SA-AF,KLUČKA GLOBE,TL/PZ | Strieborna EV1 |        | 89-889589  |
| SA-AF,KLUČKA GLOBE,TL/PZ | Bronz F4       |        | 89-889573  |
| SA-AF,KLUČKA GLOBE,TL/PZ | Titan mat F9   |        | 89-889572  |
| SA-AF,KLUČKA GLOBE,TL/PZ | Biela R90016   |        | 89-889534  |

**PRISLUŠENSTVO**



| Typ                       | Povrch. úprava | Rozsah  | Obj. číslo |
|---------------------------|----------------|---------|------------|
| SA-KLUČKA,PRÍSL.FAV.TL/PZ |                | 55-64mm | 89-701555  |
| SA-KLUČKA,PRÍSL.FAV.TL/PZ |                | 65-74mm | 89-701553  |
| SA-KLUČKA,PRÍSL.FAV.TL/PZ |                | 75-84mm | 89-701539  |
| SA-KLUČKA,PRÍSL.FAV.TL/PZ |                | 85-94mm | 89-701522  |

**KLUČKA SI-LINE (na terasové balkónové dvere znížená)**

| Typ                         | Povrch. úprava    | Rozsah | Obj. číslo |
|-----------------------------|-------------------|--------|------------|
| KLUČKA SI-LINE TL/PZ IUA,FL | Tmavo hnedá R8022 |        | 89-702413  |
| KLUČKA SI-LINE TL/PZ IUA,FL | Biela R90016      |        | 89-702406  |

**KLUČKA SI-LINE (znížená, štvorhran 50mm)**

| Typ                    | Povrch. úprava    | Obj. číslo |
|------------------------|-------------------|------------|
| SA-FS,KLUČKA,FAV,FL,50 | Strieborná EV1    | 89-713464  |
| SA-FS,KLUČKA,FAV,FL,50 | Tmavo hnedá R8022 | 89-713457  |

**KLUČKA SI-LINE (znížená, štvorhran 35mm)**

| Typ                         | Povrch. úprava    | Obj. číslo |
|-----------------------------|-------------------|------------|
| SA-KLUČKA SI-LINE,FAV,FL,35 | Tmavo hnedá R8022 | 89-702062  |
| SA-KLUČKA SI-LINE,FAV,FL,35 | Biela R90016      | 89-702055  |

| Typ                | Povrch. úprava | Obj. číslo |
|--------------------|----------------|------------|
| SA-AF,ROZETA GLOBE | Biela R90016   | 89-818909  |





TOKIO 0710/U26/35



TOKIO 0710/SV/U26/35



ATLANTA 0530/US952/35



ATLANTA 0530/S/US952/35



ATLANTA 0530/delený štítok

**KĽUČKA TOKIO**

| Typ                | Povrch. úprava    | Obj. číslo  |
|--------------------|-------------------|-------------|
| 0710/U26/35        | F99               | 75-01759393 |
| 0710/U26/35        | F4                | 75-01925953 |
| 0710/U26/35        | F9                | 75-01925961 |
| 0710/SV/U26/35     | F99 poistka       | 89-600001   |
| 0710/SV/U26/35     | F4 poistka        | 89-600002   |
| 0710/delený štítok | F99 K/K, DŠ       | 89-813744   |
| 0710/delený štítok | F4 K/K, DŠ, nízka | 89-812739   |

**Povrchová úprava:**

F1 - strieborná

F4 - bronzová

F9 - oceľ (ako titan)

F99 - biela

**KĽUČKA ATLANTA (35 štvorhran)**

| Typ           | Rozsah | Povrch. úprava | Obj. číslo  |
|---------------|--------|----------------|-------------|
| 0530/US952/35 |        | F99            | 75-02245765 |
| 0530/US952/35 |        | F1             | 75-02296431 |
| 0530/US952/35 |        | F4             | 75-02245749 |
| 0530/US952/35 |        | F9             | 75-02245757 |

**KĽUČKA ATLANTA (na terasové balkónové dvere)**

|                    |                   |            |             |
|--------------------|-------------------|------------|-------------|
| 0530/delený štítok | <b>87 - 92 mm</b> | F9 K/K, DŠ | 75-02471463 |
| 0530/delený štítok | <b>87 - 92 mm</b> | F1 K/K, DŠ | 75-02471447 |
| 0530/delený štítok | <b>87 - 92 mm</b> | F4 K/K, DŠ | 75-03288880 |

**KĽUČKA ATLANTA (uzamykateľná)**

|                 |  |     |             |
|-----------------|--|-----|-------------|
| 0530/S/US952/35 |  | F9  | 75-02257977 |
| 0530/S/US952/35 |  | F99 | 75-02257985 |
| 0530/S/US952/35 |  | F4  | 75-02306564 |
| 0530/S/US952/35 |  | F1  | 75-02257969 |

**KĽUČKA ATLANTA (TBT)**

|                 |  |     |             |
|-----------------|--|-----|-------------|
| 0530/S/US952/35 |  | F9  | 75-02726251 |
| 0530/S/US952/35 |  | F99 | 75-02726260 |
| 0530/S/US952/35 |  | F4  | 75-02726243 |
| 0530/S/US952/35 |  | F1  | 75-02726235 |

**POLOVIČNÉ GARNITURY**



| Typ                             | Povrch. úprava       | Obj. číslo  |
|---------------------------------|----------------------|-------------|
| HP-KOV.LIV,1/2,GAR.1313G/55     | F1 Hliník            | 75-02906076 |
| HP-KOV.LIV,1/2,GAR.1313G/55     | F7807<br>Tmavo hnedá | 75-02899419 |
| HP-KOV.PAR,1/2GAR.E138F/42-E42S | Nerez                | 75-06493126 |
| HP-KOV.PAR,1/2GAR.E138GF/3357SN | Nerez                | 75-01926171 |
| HP-KOV.PRÍSLUŠENSTVO K,1/2GAR.  |                      | 75-06661250 |



LIVERPOOL,1/2,GAR.1313G/55



PARIS,1/2GAR.E138F/42-E42S



PARIS,1/2GAR.  
E138GF/3357SN

príslušenstvo k polrozete



**POLROZETY**



| Typ                           | Povrch. úprava       | Obj. číslo  |
|-------------------------------|----------------------|-------------|
| HP-KOV.ROZ.OKRUHLA,VON,E42NSB | Nerez                | 75-02916063 |
| HP-KOV.ROZ.OVÁLNA,VON,55S     | F1 Hliník            | 75-02906691 |
| HP-KOV.ROZ.OVÁLNA,VON,55S     | F8707<br>Tmavo hnedá | 75-02708230 |



ROZETA OKRÚHLA,VON,E42NSB



ROZETA OVÁLNA,VON,55S

**PRÍSLUŠENSTVO K MADLÁM  
NA DREVENÉ DVERE / POLGARNITÚRAM**

| Typ                             | Povrch. úprava | Obj. číslo  |
|---------------------------------|----------------|-------------|
| HP-MADLO,PRÍSLUŠ.DREVO,BS-201/B |                | 75-00562879 |

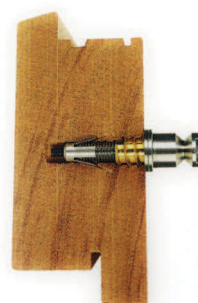

**MADIELKA NA POSUVNÉ DVERE**



| Typ              | Povrch. úprava    | Obj. číslo  |
|------------------|-------------------|-------------|
| HP-MADIELKO,M493 | F49 chróm lesklý  | 75-02071689 |
| HP-MADIELKO,M493 | F49 chróm matný   | 75-02071654 |
| HP-MADIELKO,M493 | F71 mosadz lesklý | 75-02071611 |



**MONTÁŽNE KLÚČE (kovanie Sigenia Aubi)**

| Typ                           | Obj. číslo |
|-------------------------------|------------|
| NASTAVOVACÍ,FAV,IMBUS         | 89-702611  |
| NASTAVOVACÍ,FAV,SW4/SW11,OČKO | 89-702581  |
| KLÚČKA MONTÁŽNA,FAV,R9005     | 89-702536  |

### 3.2 KLUČKY NA VCHODOVÉ DVERE



K/K



G/K



K/K



G/K



K/K



G/K



K/K



G/K

#### KLUČKA LONDON (113) 8/92 úzky štítok 30 mm



| Typ | Hrúb. krídla | Povrch. úprava | Trieda bezpeč. | Obj. číslo  |
|-----|--------------|----------------|----------------|-------------|
| K/K | 72 - 78 mm   | F99            | -              | 75-02602726 |
| G/K | 67 - 72 mm   | F99            | -              | 75-02273900 |
| K/K | 87 - 92 mm   | F4             | -              | 75-03667433 |
| G/K | 67 - 72 mm   | F4             | -              | 75-02273897 |
| K/K | 67 - 72 mm   | F9             | -              | 75-02602726 |
| G/K | 67 - 72 mm   | F1             | -              | 75-02322046 |

#### Povrchová úprava:

F1 - strieborná

F4 - bronzová

F9 - oceľ (ako titan)

F99 - biela

#### KLUČKA TŔKYŔ (1710) 8/92 úzky štítok 30 mm



| Typ | Hrúbka krídla | Povrch. úprava | Trieda bezpeč. | Obj. číslo  |
|-----|---------------|----------------|----------------|-------------|
| K/K | 67 - 72 mm    | F9             | -              | 75-02137713 |
| G/K | 67 - 72 mm    | F9             | -              | 75-02137772 |
| K/K | 67 - 72 mm    | F4             | -              | 75-02085773 |
| G/K | 67 - 72 mm    | F4             | -              | 75-02137721 |
| K/K | 67 - 72 mm    | F1             | -              | 75-02137570 |
| G/K | 67 - 72 mm    | F1             | -              | 75-02137684 |

#### KLUČKA LONDON (113) 8/92 široký štítok 54 mm



| Typ | Hrúbka krídla     | Trieda bezpečnosti | Povrch. úprava | Obj. číslo  |
|-----|-------------------|--------------------|----------------|-------------|
| K/K | <b>87 - 92 mm</b> | ES0 (SK1)          | F1             | 75-03672742 |
| G/K | <b>87 - 92 mm</b> | ES0 (SK1)          | F1             | 75-03670317 |
| K/K | 77 - 82 mm        | ES1 (SK2)          | F1 ZA          | 75-02877287 |
| G/K | 77 - 82 mm        | ES1 (SK2)          | F1 ZA          | 75-02877720 |
| K/K | <b>87 - 92 mm</b> | ES0 (SK1)          | F4             | 75-03672751 |
| G/K | <b>87 - 92 mm</b> | ES0 (SK1)          | F4             | 75-03670341 |
| K/K | 77 - 82 mm        | ES1 (SK2)          | F4 ZA          | 75-02089678 |
| G/K | 77 - 82 mm        | ES1 (SK2)          | F4 ZA          | 75-02089660 |
| K/K | 77 - 82 mm        | ES0 (SK1)          | F99            | 75-06958300 |
| G/K | 77 - 82 mm        | ES0 (SK1)          | F99            | 75-06964480 |

#### KLUČKA PARIS (138) 8/92 široký štítok 54 mm



| Typ | Hrúbka krídla | Trieda bezpečnosti | Povrch. úprava | Obj. číslo  |
|-----|---------------|--------------------|----------------|-------------|
| K/K | 67 - 72 mm    | ES0 (SK1)          | F4             | 75-00654796 |
| G/K | 67 - 72 mm    | ES0 (SK1)          | F4             | 75-00840182 |

**KĽUČKA VERONA (1510) 8/92**  
široký štítok 54 mm



| Typ | Hrúbka krídla | Trieda bezpečnosti | Povrch. úprava | Obj. číslo  |
|-----|---------------|--------------------|----------------|-------------|
| K/K | 87 - 92 mm    | ES1 (SK2)          | F9             | 75-03670384 |
| G/K | 87 - 92 mm    | ES1 (SK2)          | F9             | 75-03670368 |
| K/K | 87 - 92 mm    | ES1 (SK2)          | F1             | 75-03244271 |
| G/K | 87 - 92 mm    | ES1 (SK2)          | F1             | 75-03670325 |
| K/K | 87 - 92 mm    | ES1 (SK2)          | F4             | 75-03670376 |
| G/K | 87 - 92 mm    | ES1 (SK2)          | F4             | 75-03670350 |



K/K



G/K

**KĽUČKA ATLANTA (1530) 8/92**  
štítok 35 mm



| Typ | Hrúbka krídla | Trieda bezpečnosti | Povrch. úprava | Obj. číslo  |
|-----|---------------|--------------------|----------------|-------------|
| K/K | 67 - 72 mm    | ES0 (SK1)          | F9             | 75-02698561 |
| M/K | 67 - 72 mm    | ES0 (SK1)          | F9             | 75-02698465 |
| G/K | 67 - 72 mm    | ES0 (SK1)          | F9             | 75-02741988 |
| K/K | 67 - 72 mm    | ES0 (SK1)          | F1             | 75-02421634 |
| M/K | 67 - 72 mm    | ES0 (SK1)          | F1             | 75-02419761 |
| G/K | 67 - 72 mm    | ES0 (SK1)          | F1             | 75-02421482 |
| K/K | 67 - 72 mm    | ES0 (SK1)          | F4             | 75-02741030 |
| M/K | 67 - 72 mm    | ES0 (SK1)          | F4             | 75-02740934 |
| G/K | 67 - 72 mm    | ES0 (SK1)          | F4             | 75-02740942 |
| K/K | 67 - 72 mm    | ES0 (SK1)          | F99            | 75-02421651 |



G/K



M/K

**KĽUČKA LUXEBURG (1500) 8/92**  
štítok 35 mm



| Typ | Hrúbka krídla | Trieda bezpečnosti | Povrch. úprava | Obj. číslo  |
|-----|---------------|--------------------|----------------|-------------|
| K/K | 72 - 77 mm    | ES0 (SK1)          | F9             | 75-06990949 |
| M/K | 72 - 77 mm    | ES0 (SK1)          | F9             | 75-02202378 |
| K/K | 72 - 77 mm    | ES0 (SK1)          | F99            | 75-08002917 |
| G/K | 67 - 72 mm    | ES0 (SK1)          | F99            | 75-02089791 |
| M/K | 72 - 77 mm    | ES0 (SK1)          | F99            | 75-02421511 |
| K/K | 72 - 77 mm    | ES0 (SK1)          | F4             | 75-02896867 |
| M/K | 72 - 77 mm    | ES0 (SK1)          | F4             | 75-08165144 |
| G/K | 72 - 77 mm    | ES0 (SK1)          | F4             | 75-02345678 |



K/K



M/K

**SKRUTKY K ROZŠÍRENIU 82-87**

| Obj. číslo  |
|-------------|
| 75-07167588 |

**ROZŠÍRENIE K/K 82-87**

| Obj. číslo                    |             |
|-------------------------------|-------------|
| Štvorhran delený 8 x 8/160 mm | 75-04528745 |
| Štvorhran plný 8 x 8/160 mm   | 75-04220228 |

**ROZŠÍRENIE G/K 82-87**

| Obj. číslo  |
|-------------|
| 75-00823277 |



### 3.3 KĽUČKY NA INTERIÉROVÉ DVERE



#### KĽUČKA MOSADZNÁ BYSTRICA



| Typ | Povrchová úprava | Obj. číslo  |
|-----|------------------|-------------|
| BB  | Nikel matný      | 24-90000002 |
| PZ  | Nikel matný      | 24-91000002 |
| WC  | Nikel matný      | 24-92000002 |

#### KĽUČKA MOSADZNÁ BRATISLAVA



| Typ | Povrchová úprava | Obj. číslo  |
|-----|------------------|-------------|
| BB  | Nikel matný      | 24-90000013 |
| PZ  | Nikel matný      | 24-91000013 |
| WC  | Nikel matný      | 24-92000013 |

#### KĽUČKA MOSADZNÁ KOŠICE



| Typ | Povrchová úprava | Obj. číslo  |
|-----|------------------|-------------|
| BB  | Nikel matný      | 24-90000009 |
| PZ  | Nikel matný      | 24-90000009 |
| WC  | Nikel matný      | 24-90000009 |

**KĽUČKA MOSADZNÁ ARCADIA**



| Typ | Povrchová úprava | Obj. číslo |
|-----|------------------|------------|
| BB  | Nikel matný      | 76-0004    |
| PZ  | Nikel matný      | 76-0005    |
| WC  | Nikel matný      | 76-0006    |



**KĽUČKA MOSADZNÁ DENVER**



| Typ | Povrchová úprava     | Obj. číslo |
|-----|----------------------|------------|
| BB  | Nikel matný / lesklý | 76-1341    |
| PZ  | Nikel matný / lesklý | 76-1343    |
| WC  | Nikel matný / lesklý | 76-1347    |



**KĽUČKA MOSADZNÁ INKA PLUS**



| Typ | Povrchová úprava     | Obj. číslo |
|-----|----------------------|------------|
| BB  | Nikel matný / lesklý | 76-5041    |
| PZ  | Nikel matný / lesklý | 76-5043    |
| WC  | Nikel matný / lesklý | 76-5047    |

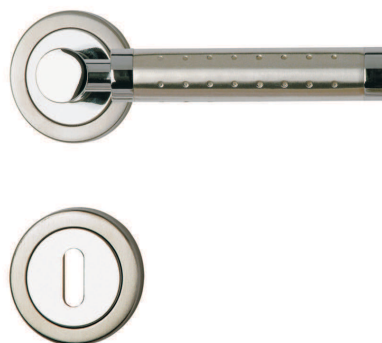

**KĽUČKA MOSADZNÁ MERKUR**



| Typ | Povrchová úprava     | Obj. číslo |
|-----|----------------------|------------|
| BB  | Nikel matný / lesklý | 76-0201    |
| PZ  | Nikel matný / lesklý | 76-0174    |
| WC  | Nikel matný / lesklý | 76-0175    |



**KĽUČKA MOSADZNÁ VERONA - R**



| Typ | Povrchová úprava | Obj. číslo |
|-----|------------------|------------|
| BB  | Chróm            | 76-0074    |
| BB  | Nikel matný      | 76-0077    |
| PZ  | Chróm            | 76-0075    |
| PZ  | Nikel matný      | 76-0078    |
| WC  | Chróm            | 76-0076    |
| WC  | Nikel matný      | 76-0079    |



**KLÚČKA MOSADZNÁ VERONA**

| Typ | Rozteč | Povrchová úprava | Obj. číslo |
|-----|--------|------------------|------------|
| BB  | 72 mm  | Chróm            | 76-0140    |
| BB  | 72 mm  | Nikel matný      | 76-0067    |
| PZ  | 72 mm  | Chróm            | 76-0144    |
| PZ  | 72 mm  | Nikel matný      | 76-0069    |
| WC  | 72 mm  | Nikel matný      | 76-1090    |
| BB  | 90 mm  | Chróm            | 76-0143    |
| BB  | 90 mm  | Nikel matný      | 76-0068    |
| PZ  | 90 mm  | Chróm            | 76-0145    |
| PZ  | 90 mm  | Nikel matný      | 76-0070    |
| WC  | 90 mm  | Nikel matný      | 76-0277    |

**KLÚČKA MOSADZNÁ VIOLETTA - R**

| Typ | Povrchová úprava | Obj. číslo |
|-----|------------------|------------|
| BB  | Mosadz lesklá    | 76-0088    |
| BB  | Nikel matný      | 76-0238    |
| PZ  | Chróm            | 76-0092    |
| PZ  | Mosadz lesklá    | 76-0089    |
| PZ  | Nikel matný      | 76-0239    |
| WC  | Chróm            | 76-0093    |
| WC  | Mosadz lesklá    | 76-0090    |
| WC  | Nikel matný      | 76-0240    |

**KLÚČKA MOSADZNÁ VIOLETTA 72 mm**

| Typ       | Rozteč | Povrchová úprava | Obj. číslo |
|-----------|--------|------------------|------------|
| BB        | 72 mm  | Chróm            | 76-0084    |
| BB        | 72 mm  | Nikel matný      | 76-0228    |
| BB        | 72 mm  | Mosadz lesklá    | 76-0104    |
| PZ        | 72 mm  | Chróm            | 76-0086    |
| PZ        | 72 mm  | Nikel matný      | 76-0230    |
| PZ        | 72 mm  | Mosadz lesklá    | 76-0105    |
| WC        | 72 mm  | Chróm            | 76-0149    |
| WC        | 72 mm  | Nikel matný      | 76-0232    |
| WC        | 72 mm  | Mosadz lesklá    | 76-0111    |
| G/K ľavá  | 72 mm  | Chróm            | 76-0129    |
| G/K pravá | 72 mm  | Chróm            | 76-0128    |
| G/K ľavá  | 72 mm  | Nikel matný      | 76-0234    |
| G/K pravá | 72 mm  | Nikel matný      | 76-0235    |
| G/K ľavá  | 72 mm  | Mosadz lesklá    | 76-0125    |
| G/K pravá | 72 mm  | Mosadz lesklá    | 76-0124    |



**KLUČKA MOSADZNÁ VIOLETTA 90 mm**



| Typ       | Rozteč | Povrchová úprava | Obj. číslo |
|-----------|--------|------------------|------------|
| BB        | 90 mm  | Chróm            | 76-0085    |
| BB        | 90 mm  | Nikel matný      | 76-0229    |
| BB        | 90 mm  | Mosadz lesklá    | 76-0100    |
| PZ        | 90 mm  | Chróm            | 76-0087    |
| PZ        | 90 mm  | Nikel matný      | 76-0231    |
| PZ        | 90 mm  | Mosadz lesklá    | 76-0101    |
| WC        | 90 mm  | Chróm            | 76-0148    |
| WC        | 90 mm  | Nikel matný      | 76-0233    |
| WC        | 90 mm  | Mosadz lesklá    | 76-0102    |
| G/K lavá  | 90 mm  | Chróm            | 76-0127    |
| G/K pravá | 90 mm  | Chróm            | 76-0126    |
| G/K lavá  | 90 mm  | Nikel matný      | 76-0236    |
| G/K pravá | 90 mm  | Nikel matný      | 76-0237    |
| G/K lavá  | 90 mm  | Mosadz lesklá    | 76-0123    |
| G/K pravá | 90 mm  | Mosadz lesklá    | 76-0122    |



**KLUČKA HLINÍKOVÁ ELOXOVANÁ EUROPA**



| Typ | Rozteč | Povrchová úprava | Obj. číslo |
|-----|--------|------------------|------------|
| BB  | 72 mm  | F1 - hliník      | 76-0020    |
| BB  | 72 mm  | F2 - šampaň      | 76-0025    |
| BB  | 72 mm  | F3 - zlatá       | 76-0219    |
| BB  | 72 mm  | F4 - bronz       | 76-0030    |
| PZ  | 72 mm  | F1 - hliník      | 76-0022    |
| PZ  | 72 mm  | F2 - šampaň      | 76-0027    |
| PZ  | 72 mm  | F3 - zlatá       | 76-0224    |
| PZ  | 72 mm  | F4 - bronz       | 76-0032    |
| WC  | 72 mm  | F1 - hliník      | 76-0024    |
| WC  | 72 mm  | F2 - šampaň      | 76-0029    |
| WC  | 72 mm  | F3 - zlatá       | 76-0226    |
| WC  | 72 mm  | F4 - bronz       | 76-0034    |
| BB  | 90 mm  | F1 - hliník      | 76-0021    |
| BB  | 90 mm  | F2 - šampaň      | 76-0026    |
| BB  | 90 mm  | F3 - zlatá       | 76-0223    |
| BB  | 90 mm  | F4 - bronz       | 76-0031    |
| PZ  | 90 mm  | F1 - hliník      | 76-0023    |
| PZ  | 90 mm  | F2 - šampaň      | 76-0028    |
| PZ  | 90 mm  | F3 - zlatá       | 76-0225    |
| PZ  | 90 mm  | F4 - bronz       | 76-0033    |
| WC  | 90 mm  | F1 - hliník      | 76-0115    |
| WC  | 90 mm  | F2 - šampaň      | 76-0113    |
| WC  | 90 mm  | F3 - zlatá       | 76-0227    |
| WC  | 90 mm  | F4 - bronz       | 76-0114    |



**KĽUČKA HLINÍKOVÁ ELOXOVANÁ KIM**

| Typ | Povrchová úprava | Obj. číslo |
|-----|------------------|------------|
| BB  | F1 - hliník      | 76-0167    |
| BB  | F9 - oceľ        | 76-0168    |
| PZ  | F1 - hliník      | 76-0250    |
| PZ  | F9 - oceľ        | 76-0252    |
| WC  | F1 - hliník      | 76-0251    |
| WC  | F9 - oceľ        | 76-0253    |

**KĽUČKA HLINÍKOVÁ ELOXOVANÁ NOVA**

| Typ | Povrchová úprava | Obj. číslo |
|-----|------------------|------------|
| BB  | F1 - hliník      | 76-0041    |
| BB  | F2 - šampaň      | 76-0044    |
| PZ  | F1 - hliník      | 76-0042    |
| PZ  | F2 - šampaň      | 76-0045    |
| WC  | F1 - hliník      | 76-0043    |
| WC  | F2 - šampaň      | 76-0046    |

**KĽUČKA ANTIKOROVÁ BRISBANE**

| Typ | Povrchová úprava        | Obj. číslo |
|-----|-------------------------|------------|
| PZ  | Antikoro matné / lesklé | 76-0180    |
| WC  | Antikoro matné / lesklé | 76-0181    |

**KĽUČKA ANTIKOROVÁ CUBA**

| Typ | Povrchová úprava | Obj. číslo |
|-----|------------------|------------|
| BB  | Antikoro brúsené | 76-5541    |
| PZ  | Antikoro brúsené | 76-5543    |
| WC  | Antikoro brúsené | 76-5547    |
| G/K | Antikoro brúsené | 76-5053    |

**KĽUČKA ANTIKOROVÁ GOLF**

| Typ | Povrchová úprava | Obj. číslo |
|-----|------------------|------------|
| BB  | Antikoro brúsené | 76-2411    |
| PZ  | Antikoro brúsené | 76-2431    |
| WC  | Antikoro brúsené | 76-2432    |

**KLUČKA ANTIKOROVÁ METRO**



| Typ | Povrchová úprava | Obj. číslo |
|-----|------------------|------------|
| BB  | Antikoro brúsené | 76-5410    |
| PZ  | Antikoro brúsené | 76-5430    |
| WC  | Antikoro brúsené | 76-5470    |



**KLUČKA ANTIKOROVÁ SWING**



| Typ | Povrchová úprava | Obj. číslo |
|-----|------------------|------------|
| BB  | Antikoro brúsené | 76-5441    |
| PZ  | Antikoro brúsené | 76-5443    |
| WC  | Antikoro brúsené | 76-5447    |



**KLUČKA KOVANÁ TILLY - R 310 / 374**



| Typ | Povrchová úprava       | Obj. číslo |
|-----|------------------------|------------|
| BB  | Čierny pozink lakovaný | 76-0211    |
| PZ  | Čierny pozink lakovaný | 76-0212    |



**KLUČKA ATLANTA (1530)  
s rýchloštvorhranom**



| Typ | Povrchová úprava | Obj. číslo  |
|-----|------------------|-------------|
| BB  | F9 - oceľ        | 75-02791352 |
| PZ  | F9 - oceľ        | 75-02791281 |
| WC  | F9 - oceľ        | 75-02791256 |





**KLUČKA DENVER (1310)  
s rýchloštvorhranom**



| Typ | Povrchová úprava | Obj. číslo  |
|-----|------------------|-------------|
| BB  | Antikoro         | 75-02820416 |
| PZ  | Antikoro         | 75-02820424 |
| WC  | Antikoro         | 75-0820467  |



**KĽUČKA BILBAO (1365)**  
s rýchloštvorhranom

| Typ  | Povrchová úprava | Obj. číslo  |
|--|------------------|-------------|
| BB  | Antikoro         | 75-02820061 |
| PZ  | Antikoro         | 75-02820096 |
| WC  | Antikoro         | 75-0820117  |

**MADIELKO (M493)**

| Povrchová úprava    | Obj. číslo  |
|---------------------|-------------|
| F49 - chróm lesklý  | 75-02071611 |
| F71 - mosadz lesklá | 75-02071689 |



.....HCS/ŠTANDARD



.....HCS/15/15

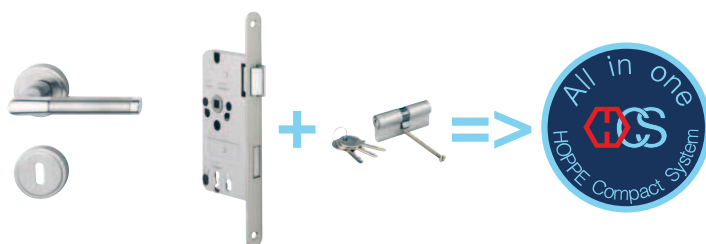

.....HCS/SK/OL15

**KĽUČKY HCS**

Nové kľučky HCS spájajú do jedného celku kompletný systém uzatvárania dverí. Obsahujú v sebe samotnú kľučku, zámok aj vložku, alebo WC poistku. Preto sa môžu právom pomenovávať „ALL in ONE“ (všetko v jednom).

Výhody kľučiek HCS:

- rýchla montáž,
- žiadne frézovanie a dlabanie, len navrtanie dvoch otvorov,
- kompaktný variabilný systém,
- možnosť rôznych kombinácií zabezpečenia (WC poistky, vložky ...),
- možnosť osadenia do falcových, bezfalcových a aj sklenených dverí,
- elegantný dizajn,
- perfektné prevedenie,
- rôzne tvary, farby a materiály.

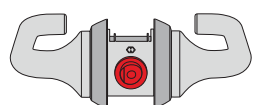

HCS SO SYMETRICKÝM JAZÝČKOM

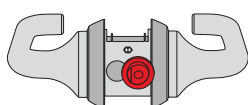

HCS S ASYMETRICKÝM JAZÝČKOM

**KLÚČKA ATLANTA (1530) HCS**  
na dvere so symetrickým jazýčkom



| Typ                | Povrchová úprava | Obj. číslo  |
|--------------------|------------------|-------------|
| BB  Štandard/Štulp | F9 - oceľ        | 75-02573064 |
| BB  Štandard/Štulp | F1 - hliník      | 75-02573048 |
| PZ  15/15/Štulp    | F9 - oceľ        | 75-0573451  |
| WC  SK/OL15/Štulp  | F9 - oceľ        | 75-02573371 |



**KLÚČKA ATLANTA (1530)**  
HCS na sklené dvere



| Typ               | Povrchová úprava | Obj. číslo  |
|-------------------|------------------|-------------|
| BB  Štandard/sklo | F1 - hliník      |             |
| PZ  15/15/sklo    | F1 - hliník      |             |
| WC  SK/OL15/sklo  | F1 - hliník      | 75-02574201 |



**PROTIKUS DVOJKRÍDLA ATLANTA (1530)**  
HCS na sklené dvere



| Povrchová úprava | Obj. číslo  |
|------------------|-------------|
| F1 - hliník      | 75-02574534 |



**PROTIKUS HCS NA DREVENÚ ZÁRUBŇU**



| Typ      | Povrchová úprava     | Obj. číslo |
|----------|----------------------|------------|
| HCS SB-E | F69 - antikoro matné | 75-623082  |
| HCS SB-D | F69 - antikoro matné | 75-623075  |
| HCS SB-C | F69 - antikoro matné | 75-2574913 |



HCS SB-E

HCS SB-D

HCS SB-C

**PRÍSLUŠENSTVO K HCS**



| Typ         | Povrchová úprava | Obj. číslo |
|-------------|------------------|------------|
| OL -15      | F9 - oceľ        | 75-2574964 |
| OL -15      | F1 - hliník      | 75-2574921 |
| OL -15-SEN  | F9 - oceľ        | 75-2574981 |
| OL -15-SEN  | F1 - hliník      | 75-2574956 |
| SK-15       | F9 - oceľ        | 75-2574972 |
| SK-15       | F1 - hliník      | 75-2574948 |
| ZYL -15 kus |                  | 75-591732  |
| ZYL -15 pár |                  | 75-766260  |
| RGSK-15     |                  | 75-2602291 |



OL -15

OL -15-SEN

SK-15



ZYL -15

RGSK-15

## 4.1 ZÁMKY NA INTERIÉROVÉ DVERE



TYP 101 ERGO

TYP 121

TYP 101 CLUDO

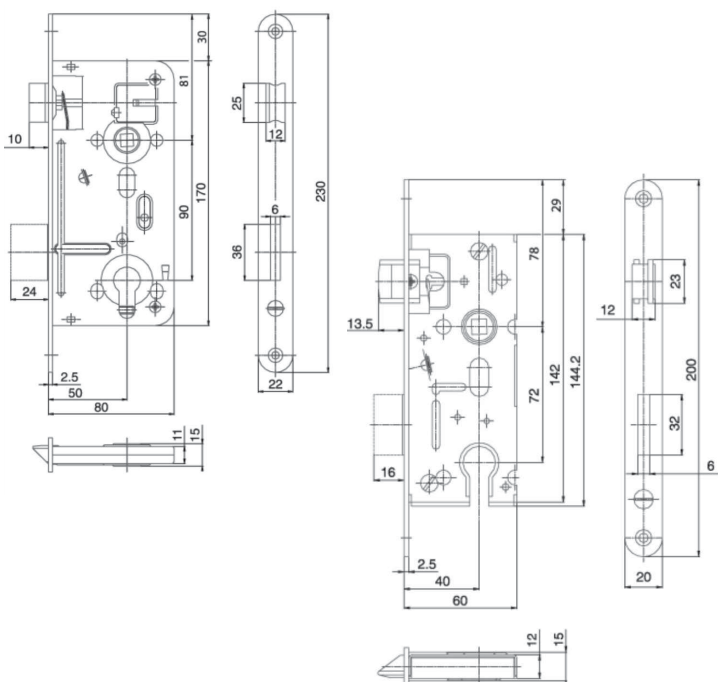
**TOP  
KVALITA**

### ZÁMOK DVEROVÝ ZADLABÁVACÍ

| Typ          | Rozteč | Rozmery čela    | Strelka          | Povrch. úprava | Obj. číslo  |
|--------------|--------|-----------------|------------------|----------------|-------------|
| 121.KB       | 90 mm  | 250 x 18 x 3 mm | Zinková zliatina | Nikel          | 81-11679976 |
| 101.KB ERGO  | 90 mm  | 250 x 18 x 3 mm | Silikón          | Nikel          | 81-11691322 |
| 101.WC ERGO  | 90 mm  | 250 x 18 x 3 mm | Silikón          | Nikel          | 81-11691326 |
| 125.WC       | 90 mm  | 250 x 18 x 3 mm | Zinková zliatina | Nikel          | 81-11623129 |
| 121.WZ       | 90 mm  | 250 x 18 x 3 mm | Zinková zliatina | Nikel          | 81-11634356 |
| 101.KB CLUDO | 90 mm  | 250 x 18 x 3 mm | Magnet. strelka  | Nikel          | 81-11703451 |
| 101.WC CLUDO | 90 mm  | 250 x 18 x 3 mm | Magnet. strelka  | Nikel          | 81-11703452 |
| 101.FA CLUDO | 90 mm  | 250 x 18 x 3 mm | Magnet. strelka  | Nikel          | 81-11711030 |
|              | 90 mm  |                 |                  |                | 24-90005090 |
|              | 90 mm  |                 |                  |                | 24-90005091 |

**PRIAZNIVÁ  
CENA** €

### ZÁMOK DVEROVÝ ZADLABÁVACÍ

| Typ       | Rozteč | Rozmery čela      | Strelka          | Povrch. úprava | Obj. číslo |
|-----------|--------|-------------------|------------------|----------------|------------|
| 548A.HO   | 90 mm  | 230 x 22 x 2,5 mm | Zinková zliatina | Nikel          | 19-4091    |
| 536A.HO   | 90 mm  | 230 x 22 x 2,5 mm | Zinková zliatina | Nikel          | 19-4025    |
| 540A.HO   | 90 mm  | 230 x 22 x 2,5 mm | Zinková zliatina | Nikel          | 19-4090    |
| 24026A.HO | 90 mm  | 230 x 22 x 2,5 mm | Zinková zliatina | Nikel          | 19-4141    |

**PRIAZNIVÁ  
CENA** €

### ZÁMOK DVEROVÝ ZADLABÁVACÍ

| Typ     | Rozteč | Rozmery čela      | Strelka          | Povrch. úprava | Obj. číslo |
|---------|--------|-------------------|------------------|----------------|------------|
| K104.HO | 72 mm  | 200 x 20 x 2,5 mm | Zinková zliatina | Nikel          | 19-4088    |
| K103.HO | 72 mm  | 200 x 20 x 2,5 mm | Zinková zliatina | Nikel          | 19-4040    |
| K111.HO | 72 mm  | 200 x 20 x 2,5 mm | Zinková zliatina | Nikel          | 19-4048    |
| K105.HO | 72 mm  | 200 x 20 x 2,5 mm | Zinková zliatina | Nikel          | 19-4153    |

**ZÁMOK DVEROVÝ ZADLABÁVACÍ**



| Typ  | Rozteč | Rozmery čela    | Strelka          | Povrch. úprava | Obj. číslo |
|--|--------|-----------------|------------------|----------------|------------|
| 115.KFV<br> | 72 mm  | 235 x 18 x 3 mm | Zinková zliatina | Antikoro       | 75-3105006 |
| 115.KFV<br> | 78 mm  | 235 x 18 x 3 mm | Zinková zliatina | Antikoro       | 75-3104964 |
| 115.KFV<br> | 72 mm  | 235 x 18 x 3 mm | Zinková zliatina | Antikoro       | 75-3105058 |



TYP 115

**4.2 PROTIPLECHY NA INTERIÉROVÉ DVERE**

**PROTIPLECH UHLOVÝ**



| Typ        | Rozmery          | Povrch. úprava | Obj. číslo  |
|------------|------------------|----------------|-------------|
| SB.R.DS    | 210 x 20 x 9 mm  | Nikel          | 81-11644376 |
| SB.SR.9.DS | 210 x 20 x 28 mm | Nikel          | 81-11611331 |

**PROTIPLECH HLADKÝ**



| Typ       | Rozmery     | Povrch. úprava | Obj. číslo  |
|-----------|-------------|----------------|-------------|
| SB.1.DS   | 210 x 24 mm | Nikel          | 81-11611614 |
| SB.E.R.DS | 240 x 20 mm | Nikel          | 81-11613021 |



SB.R.DS



SB.SR.9.DS



SB.1.DS



SB.E.R.DS

**PROTIPLECH**



| Typ            | Rozmery          | Povrch. úprava | Obj. číslo  |
|----------------|------------------|----------------|-------------|
| SB.VAR.NL      | 210 x 20 x 9 mm  | Nikel          | 81-11260053 |
| SB.VAR.ST.LI.  | 210 x 20 mm      | Nikel          | 81-11632735 |
| SB.VAR.ST.RE   | 210 x 20 mm      | Nikel          | 81-11632737 |
| SB.BW.DS.LI    | 250 x 25 x 32 mm | Nikel          | 81-11630422 |
| SB.BW.DS.RE    | 250 x 25 x 32 mm | Nikel          | 81-11630423 |
| SB.SW.DS.LI    | 250 x 25 x 16 mm | Nikel          | 81-11664024 |
| SB.SW.DS.RE    | 250 x 25 x 16 mm | Nikel          | 81-11664025 |
| SB.ST.EÖ.DS.LI | 251 x 24 mm      | Nikel          | 81-11659559 |
| SB.ST.EÖ.DS.RE | 251 x 24 mm      | Nikel          | 81-11659562 |
| SB.SR.U.DS     | 190 x 20 x 9 mm  | Nikel          | 81-11612718 |



SB.VAR.NL



SB.BW.DS



SB.SW.DS



SB.SR.U.DS



4-501-20N    5-N.R    5-N.H    FAB.UNI    SB.RS.U.DS



SB.1410



45-NDF



115-A

**PROTIPLECH**

| Typ         | Rozmery         | Povrch. úprava | Obj. číslo  |
|-------------|-----------------|----------------|-------------|
| 4-501-20N   |                 | Antikoro       | 75-3116173  |
| 5-N.R.L     |                 | Antikoro       |             |
| 5-N.R.P     |                 | Antikoro       |             |
| 5-N.H.L     |                 | Antikoro       | 75-3116220  |
| 5-N.H.P     |                 | Antikoro       |             |
| FAB.UNI.1xL | 190 x 22 x 8 mm | Nikel          | 19-5242     |
| FAB.UNI.1xP | 190 x 22 x 8 mm | Nikel          | 19-5243     |
| FAB.UNI.2xL | 190 x 22 x 8 mm | Nikel          | 19-5245     |
| FAB.UNI.2xP | 190 x 22 x 8 mm | Nikel          | 19-5244     |
| SB.RS.U.DS  |                 | Nikel          | 81-11612718 |

**OTVÁRAČ DVERÍ**

| Typ     | Druh  | Rozmery      | Povrch. úprava | Obj. číslo  |
|---------|-------|--------------|----------------|-------------|
| SB.1410 | Mech. | 70,5 x 19 mm | Zinok          | 81-11630424 |
| 45-NDF  | Elek. | 75x28x20 mm  | Zinok          | 89-699001   |
| 115-A   | Mech. | 62x20x18 mm  | Zinok          | 75-3465936  |

**ZÁSTRČ DVEROVÁ AM-141**

| Rozmery          | Povrchová úprava | Obj. číslo |
|------------------|------------------|------------|
| 150 x 14 x 14 mm | Mosadz           | 99-0042    |
| 150 x 14 x 14 mm | Nikel            | 99-1042    |
| 400 x 14 x 14 mm | Mosadz           | 99-0043    |
| 400 x 14 x 14 mm | Nikel            | 99-1043    |
| 600 x 14 x 14 mm | Mosadz           | 99-0186    |
| 600 x 14 x 14 mm | Nikel            | 99-1186    |

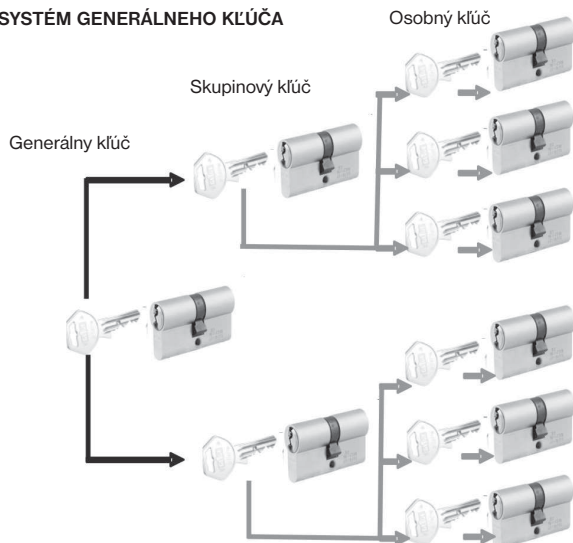
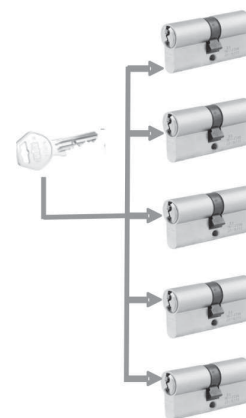
**4.3 CYLINDRICKÉ VLOŽKY MECHANICKÉ**
**SYSTÉM GENERÁLNEHO KLÚČA**

**SYSTÉM ZJEDNOTENÉHO KLÚČA**



**MECHANICKÉ CYLINDRICKÉ VLOŽKY pExtra** v blistrovom balení

Možnosti: zjednotené vložky  
systém generálneho kľúča

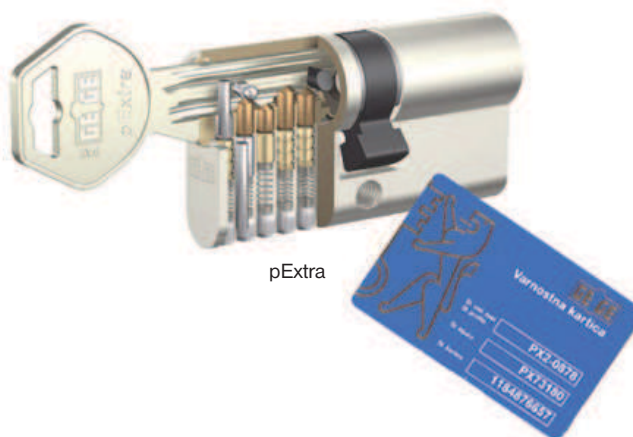
- Trieda bezpečnosti podľa NBÚ: Prísne tajné - **4. trieda**
- Postranné blokovacie elementy
- Ochrana proti SG metóde
- 5 vertikálne zoradených stavidielok
- Palec široký 9 mm
- 5 kľúčov **s bezpečnostnou kartou**
- Patentom chránený kľúč do roku 2021 s logom twd
- Úplne nový profil kľúča chránený proti laserovému kopírovaniu
- Požiarna odolnosť T90
- Ochrana proti odvrátaniu použitím prvkov z kalenej ocele
- Náhradný kľúč podľa kódu na karte v twd Banská Bystrica



pExtra

**MECHANICKÉ CYLINDRICKÉ VLOŽKY pExtra**



| Typ                     | Delenie    | Obj. číslo  |
|-------------------------|------------|-------------|
| PXA, 30/35 NI,3KL       | 30 x 35 mm | 81-11670001 |
| PXA, 40/50 NI,3KL       | 40 x 50 mm | 81-11670007 |
| PXA, 40/55 NI,3KL       | 40 x 55 mm | 81-11670002 |
| PXA, 40/60 NI,3KL       | 40 x 60 mm | 81-11670003 |
| PXA, 40/70 NI,3KL       | 40 x 70 mm | 81-11670004 |
| PXA, 45/50 NI,3KL       | 45 x 50 mm | 81-11670005 |
| PXA, 45/55 NI,3KL       | 45 x 55 mm | 81-11670008 |
| PXA, 45/65 NI,3KL       | 45 x 65 mm | 81-11670006 |
| PXA, POLVL. 5/55 NI,3KL | 5 x 55 mm  | 81-11670010 |
| PXA, POLVL. 5/65 NI,3KL | 5 x 65 mm  | 81-11670009 |

**MECHANICKÉ CYLINDRICKÉ VLOŽKY AP2pro**



v blistrovom balení

Možnosti: zjednotené vložky  
systém generálneho kľúča

- Trieda bezpečnosti podľa NBÚ: **3. trieda**
- Ochrana proti SG metóde
- 5 vertikálne zoradených stavidielok
- Palec široký 9 mm
- 5 kľúčov
- Prekrytý profil
- Požiarna odolnosť T90

| Typ                  | Delenie | Obj. číslo  |
|----------------------|---------|-------------|
| AP2-PRO,50/70,NI,5KL | 50x70   | 81-11711799 |
| AP2-PRO,50/55,NI,5KL | 50x55   | 81-11704105 |
| AP2-PRO,45/70,NI,5KL | 45x70   | 81-11704799 |
| AP2-PRO,45/60,NI,5KL | 45x60   | 81-11691687 |
| AP2-PRO,40/90,NI,5KL | 40x90   | 81-11711800 |
| AP2-PRO,40/75,NI,5KL | 40x75   | 81-11708775 |
| AP2-PRO,40/70,NI,5KL | 40x70   | 81-11702515 |
| AP2-PRO,40/60,NI,5KL | 40x60   | 81-11691684 |
| AP2-PRO,40/55,NI,5KL | 40x55   | 81-11691682 |
| AP2-PRO,40/50,NI,5KL | 40x50   | 81-11691678 |
| AP2-PRO,30/35,NI,5KL | 30x35   | 81-11691665 |



E-AP2000



AP-1000



1430-25

1430-55

**MECHANICKÉ CYLINDRICKÉ VLOŽKY AP-1000**

 Možnosti: zjednotené vložky  
stavebná vložka

| Typ                       | Delenie   | Obj. číslo  |
|---------------------------|-----------|-------------|
| AP-1000,POLVL.5/60,NI,3KL | 5x60      | 81-11604203 |
| AP-1000,POLVL.5/55,NI,3KL | 5x55      | 81-11612381 |
| AP-1000,POLVL.5/50,NI,3KL | 5x50      | 81-11642202 |
| AP-1000,POLVL.5/35,NI,3KL | 5x35      | 81-00000831 |
| AP-1000,60/60,NI,3KL      | 60x60     | 81-11234206 |
| AP-1000,55/55,NI,3KL      | 55x55     | 81-11234192 |
| AP-1000,50/70,NI,3KL      | 50x70     | 81-11673930 |
| AP-1000,50/50,NI,6KL-BSZ  | 50x50 BSZ | 81-11711046 |
| AP-1000,50/50,NI,6KL      | 50x50     | 81-11691185 |
| AP-1000,45/55,NI,6KL      | 45x55     | 81-11691854 |
| AP-1000,45/50,NI,6KL      | 45x50     | 81-11059056 |
| AP-1000,40/65,NI,6KL      | 40x65     | 81-11691186 |
| AP-1000,40/60,NI,6KL      | 40x60     | 81-11689877 |

**MAZACÍ SPRAY**

|                            |             |
|----------------------------|-------------|
| SPRAY GEGE,150ML,1968.G150 | 81-11603774 |
|----------------------------|-------------|

**DIGITÁLNA ELEKTRONICKÁ VLOŽKA**

- pracuje v systéme MIFARE
- jednoduché programovanie pomocou striebornej karty
- programovanie do 4000 užívateľov
- vlastné napájanie z batérie
- v prevedení vo vyššej verzii so softvérom  
(možnosť kontroly posledných 2000 prechodov)
- vonkajšie krytie IP 54
- súčasť balenia:
  - vložka + baterka + strieborná programovacia karta
    - príslušenstvo k rozšíreniu
    - prístupové karty KABA
    - alebo iné karty s MIFARE technológiou
    - privesok s technológiou MIFARE KABA
    - alebo iné privesky s technológiou MIFARE
    - nalepovací MIFARE klip  
(napr. na vnútornú stranu telefónu)

Variantná možnosť:

- polovičná digitálna vložka
- obojstranne priechodná programovateľná vložka

 Minimálne rozmery vložky: 30x30 mm (min. celková dĺžka 60 mm)  
(max. celková dĺžka 140 mm)

**PRÍSLUŠENSTVO**

| Typ                                  | Obj. číslo  |
|--------------------------------------|-------------|
| Servisný kľúč 1430-25                | 75-00143025 |
| Torx skrutkovač 1430-55              | 75-00143055 |
| Privesok MIFARE modrý AMIC-BE 004    | 75-00400004 |
| Programovacia karta KMID-MB 004      | 75-00400044 |
| Užívateľská karta MIFARE KMIC-BE 002 | 75-00400002 |

## 4.4 ZÁVESY NA INTERIÉROVÉ DVERE

### ZÁVES INTERIÉROVÝ 15INT

| Typ            | Nosnosť | Povrchová úprava | Obj. číslo  |
|----------------|---------|------------------|-------------|
| Dverový diel   | 40 kg   | Nikel            | 75-00011701 |
| Zárubňový diel | 40 kg   | Nikel            | 75-00011702 |
| Dverový diel   | 40 kg   | Nikel satinovaný | 75-00111701 |
| Zárubňový diel | 40 kg   | Nikel satinovaný | 75-00111702 |

### PRÍSLUŠENSTVO PRE ZÁVES 15INT

| Typ             | Povrchová úprava | Obj. číslo  |
|-----------------|------------------|-------------|
| Púzdro          | Zinok            | 75-00011703 |
| Šablóna vrtacia |                  | 75-52507100 |

### ZÁVES TECTUS 240 3D na interiérové bezfalcové drevené dvere



| Typ                      | Nosnosť | Povrchová úprava | Obj. číslo  |
|--------------------------|---------|------------------|-------------|
| TECTUS, TE240,3D,F1      | 40 kg   | Matný nikel F1   | 75-54005860 |
| PLATNIČKA, TE240,3D,FZ/1 |         | pozink           | 75-54004220 |

### ZÁVES TECTUS 340 3D na interiérové bezfalcové drevené dvere



| Typ                          | Nosnosť | Povrchová úprava | Obj. číslo  |
|------------------------------|---------|------------------|-------------|
| TECTUS TE340,3D,F1           | 80 kg   | Matný nikel F1   | 75-54015840 |
| TECTUS TE340,3D, ENERGY,F1 * | 80 kg   | Matný nikel F1   | 75-54006040 |
| TECTUS 340,3D,FR,F1**        | 80 kg   | Matný nikel F1   | 75-54006210 |
| PLATNIČKA TE340,3D,FZ/1      |         | pozink           | 75-54004090 |

\* záves s krytým prechodom káblovania

\*\* záves v prevedení pre protipožiarne dvere

### PRÍSLUŠENSTVO PRE ZÁVES TECTUS 240/340 3D

| Typ                              | Obj. číslo  |
|----------------------------------|-------------|
| ŠABLÓN, UNIVERZÁL, FRÉZOVACIA-A  | 75-52509300 |
| ŠABLÓN, TE240, RÁM, VEDENIE-A    | 75-52506916 |
| ŠABLÓN, TE240, KRÍDLO, VEDENIE-A | 75-52506926 |
| ŠABLÓN, TE340, VEDENIE-OBVOD     | 75-52506935 |
| ŠABLÓN, TE340, VEDENIE-VNUTRO    | 75-52506945 |
| Vrták 16/25, M12/1               | 75-00000010 |
| Vrták 24/25, M12/2               | 75-00000005 |
| Stopka M12/1, 12/50              | 75-00000007 |



#### NASTAVITELNOSŤ

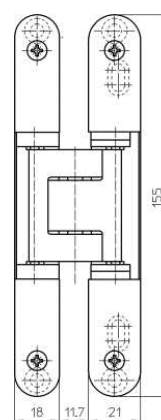
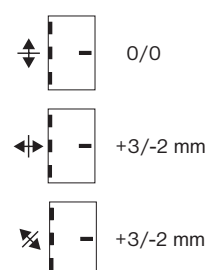

#### NASTAVITELNOSŤ

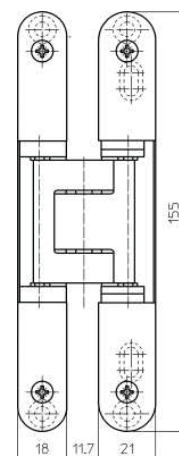
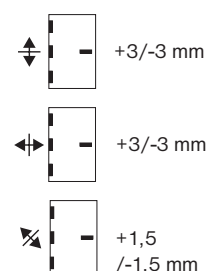

#### NASTAVITELNOSŤ

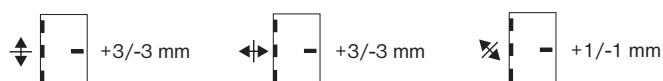

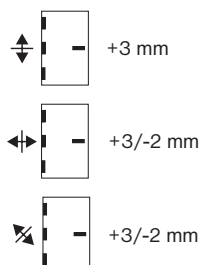
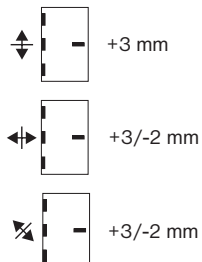
**NASTAVITELNOSŤ**

**NASTAVITELNOSŤ**

ŠTANDARD



SOFT

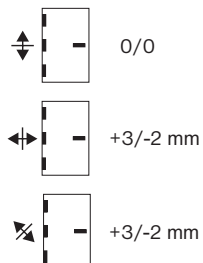

RUSTIKÁL

**NASTAVITELNOSŤ**

**ZÁVES INTERIÉROVÝ 11R15/92**  
na drevenú zárubňu

| Typ                | Nosnosť | Pov. úprava | Obj. číslo |
|--------------------|---------|-------------|------------|
| 3D, 11R15/92, ZN   | 23 kg   | Zinok       | 75-702012  |
| 3D,11R15/92,POI,ZN | 23 kg   | Zinok       | 75-706702  |

**PRÍSLUŠENSTVO PRE ZÁVES 11R15/92**

| Typ                               | Obj. číslo |
|-----------------------------------|------------|
| Šablóna vŕtacia 15/92 s odsadením | 75-021345  |

**ZÁVES INTERIÉROVÝ 11R20/112**  
na drevenú zárubňu

| Typ                 | Nosnosť | Pov. úprava | Obj. číslo |
|---------------------|---------|-------------|------------|
| 3D, 11R20/112, ZN   | 40 kg   | Zinok       | 75-706656  |
| 3D,11R20/112,POI,ZN | 40 kg   | Zinok       | 75-706705  |

**PRÍSLUŠENSTVO PRE ZÁVES 11R20/112**

| Typ                                | Obj. číslo |
|------------------------------------|------------|
| Šablóna vŕtacia 20/112 s odsadením | 75-021371  |

**KRYTKY NA 11R15/92 A 11R20/112**

| Typ               | Povrchová úprava | Obj. číslo |
|-------------------|------------------|------------|
| D15/92 plastová   | Biela            | 75-298642  |
| D15/92 hliníková  | Matný nikel      | 75-923201  |
|                   | Mosadz           | 75-923199  |
|                   | Bronz            | 75-700587  |
| D20/112 plastová  | Biela            | 75-021713  |
| D20/112 hliníková | Matný nikel      | 75-929988  |
|                   | Mosadz           | 75-929982  |
|                   | Bronz            | 75-929988  |

**ZÁVES INTERIÉROVÝ 11R15/112**  
na drevenú zárubňu

| Typ               | Nosnosť | Pov. úprava | Obj. číslo |
|-------------------|---------|-------------|------------|
| 3D, 11R15/112, ZN | 23 kg   | Zinok       | 75-706703  |

**KRYTKY NA 11R15/112**

| Typ                        | Povrchová úprava | Obj. číslo |
|----------------------------|------------------|------------|
| D15/112 hliníková ŠTANDARD | Matný nikel      | 75-929979  |
|                            | Zlatá            | 75-929976  |
| D15/112 hliníková SOFT     | Chróm            | 75-936079  |
|                            | Zlatá            | 75-944245  |
| D15/112 hliníková RUSTIKÁL | Zlatá            | 75-972181  |

**ZÁVES INTERIÉROVÝ AM50**  
na drevenú zárubňu

| Typ                 | Nosnosť | Pov. úprava | Obj. číslo |
|---------------------|---------|-------------|------------|
| AM50-9/66, KT, BR   | 10 kg   | Bronz       | 99-1028    |
| AM50-9/66, KT, MS   | 10 kg   | Mosadz      | 99-0028    |
| AM50-11/78, KT, BR  | 15 kg   | Bronz       | 99-1029    |
| AM50-11/78, KT, MS  | 15 kg   | Mosadz      | 99-0029    |
| AM50-13/90, KT, BR  | 20 kg   | Bronz       | 99-1130    |
| AM50-13/90, KT, MS  | 20 kg   | Mosadz      | 99-0030    |
| AM50-14/94, KT, BR  | 40 kg   | Bronz       | 99-1031    |
| AM50-14/94, KT, MS  | 40 kg   | Mosadz      | 99-0031    |
| AM50-16/104, KT, MS | 40 kg   | Mosadz      | 99-0032    |

**ZÁVES INTERIÉROVÝ 60/10-AN**  
na oceleovú zárubňu



| Typ                | Nosnosť | Povrchová úprava | Obj. číslo |
|--------------------|---------|------------------|------------|
| DVER.NOS.60/10-ANU | 40 kg   | Zinok            | 16-0192    |

**ZÁVES INTERIÉROVÝ PRUŽ-75/100/125**  
pružinový



| Typ                  | Nosnosť | Povrchová úprava | Obj. číslo |
|----------------------|---------|------------------|------------|
| ZAV.PRUŽ, 75, MS     | 15 kg   | Mosadz           | 16-0167    |
| ZAV.PRUŽ, 75, CHROM  | 15 kg   | Chróm            | 16-0166    |
| ZAV.PRUŽ, 100, MS    | 22 kg   | Mosadz           | 16-9684    |
| ZAV.PRUŽ, 100, CHROM | 22 kg   | Chróm            | 16-0796    |
| ZAV.PRUŽ, 125, MS    | 27 kg   | Mosadz           | 16-0792    |
| ZAV.PRUŽ, 125, CHROM | 27 kg   | Chróm            | 16-0794    |
| ZAV.PRUŽ, 150, MS    | 40 kg   | Mosadz           | 16-1168    |

**ZÁVES INTERIÉROVÝ V 0030**



| Typ             | Nosnosť | Povrch. úprava | Obj. číslo  |
|-----------------|---------|----------------|-------------|
| V 0081 HD pravý | 60 kg   | Nikel          | 75-50100611 |
| V 0081 HD ľavý  | 60 kg   | Nikel          | 75-50100612 |

**ZÁVES INTERIÉROVÝ**



| Typ                    | Nosnosť | Povrch. úprava | Obj. číslo  |
|------------------------|---------|----------------|-------------|
| V 0020 - krídlová časť | 40 kg   | Nikel          | 75-0000020  |
| V 3400 - rámová časť   | 40 kg   | Nikel          | 75-00003400 |

**KRYTKA HLINÍKOVÁ NA V 0020**



| Typ      | Povrchová úprava | Obj. číslo  |
|----------|------------------|-------------|
| Krytka 4 | Bronz            | 75-00400001 |
| Krytka 4 | Matovaná mosadz  | 75-00500001 |

**PRÍSLUŠENSTVO PRE ZÁVESY**



| Typ                        | Povrch. úprava | Obj. číslo  |
|----------------------------|----------------|-------------|
| Púzdro plastové V 3633/7,8 | Čierna         | 75-00003633 |
| Púzdro V 3604/20 zařez.    | Mosadz         | 75-00003604 |
| Púzdro oceleové V 3612/7,8 | Zinok          | 75-00003612 |
| Krytka plastová V R10      | Biela          | 75-00030002 |
| Krytka plastová V R10      | Tmavohnedá     | 75-00040002 |
| Krytka plastová V R10      | Svetlohnedá    | 75-00050002 |
| Podložka dištančná 10/2    | Nikel          | 75-51409740 |



NASTAVITELNOSŤ

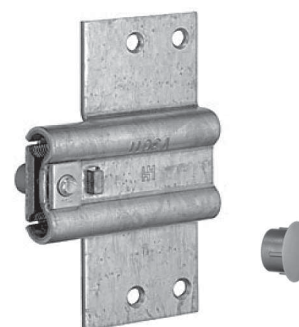
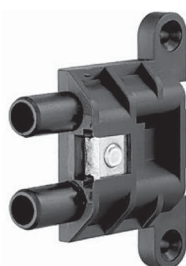
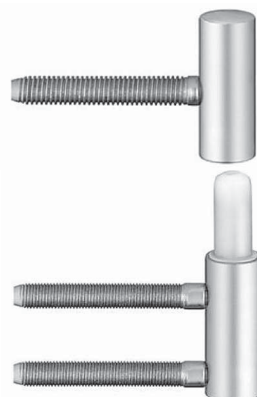
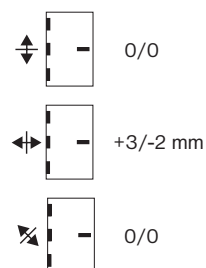



VX 7728/160



VX 7939/160



VX 7939/160-15

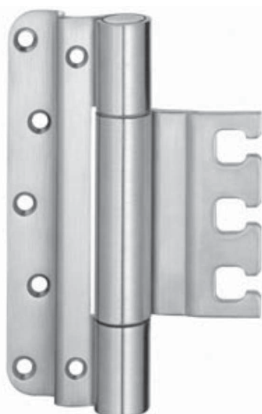

VX 7859/160



VX 2501 3D



VX 2560RR



VX 2580



VX 2570 KK



VX 2590



VX 7501 3D



VX 7560 KK



VX 7580



VX 7570 KK



VX 7590

**INTERIÉROVÉ OBJEKTOVÉ ZÁVESY RADY VX**

- os otáčania je v strede závesu
- úplná vzájomná zameniteľnosť rámových a kridlových dielov
- všetky závesy sú 3D nastaviteľné v rozmedzí  $\pm 3$  mm
- nadštandardná povrchová úprava závesov
- varianty riešenia:
 

|                                    |      |
|------------------------------------|------|
| pre požiaru odolnosť               | S    |
| pre zvýšenú bezpečnosť             | WK   |
| pre zvýšenú zvukovú nepriezvučnosť | FD   |
| pre zvýšenú hmotnosť dverí 300 kg  | 4N   |
| s poistkou proti zveseniu          | MSTS |
| pre osadenie pod hliníkovú kapotáž | 4HA  |

**Kridlová časť**

| Typ            | Nosnosť | Osadenie na kridle | Obj. číslo |
|----------------|---------|--------------------|------------|
| VX 7939/100    | 100 kg  | Do falcu naložené  |            |
| VX 7939/120    | 120 kg  |                    |            |
| VX 7939/160-15 | 160 kg  |                    |            |
| VX 7939/160-18 | 160 kg  |                    |            |
| VX 7939/160    | 200 kg  |                    |            |
| VX 7939/160-4N | 300 kg  |                    |            |
| VX 7728/100    | 80 kg   | Do falcu vložené   |            |
| VX 7728/120    | 100 kg  | Do falcu vložené   |            |
| VX 7859/120    | 100 kg  | Dvojfalc           |            |
| VX 7728/160    | 120 kg  | Do falcu vložené   |            |
| VX 7859/160    | 120 kg  | Dvojfalc           |            |
| VX 7729/100    | 100 kg  | Bezfalcové         |            |
| VX 7729/120    | 120 kg  |                    |            |
| VX 7729/160-15 | 160 kg  |                    |            |
| VX 7729/160-18 | 160 kg  |                    |            |
| VX 7729/160    | 200 kg  |                    |            |
| VX 7729/160-4N | 300 kg  |                    |            |

**Rámová časť**

| Typ        | Osadenie v zárubni | Obj. číslo |
|------------|--------------------|------------|
| VX 2501 3D | Rámová zárubňa     |            |
| VX 7501 3D | Rámová zárubňa     |            |
| VX 2502 3D | Obložková zárubňa  |            |
| VX 7502 3D | Obložková zárubňa  |            |
| VX 2505 3D | Slepá zárubňa      |            |
| VX 7505 3D | Slepá zárubňa      |            |
| VX 7611 3D | Oceľová zárubňa    |            |
| VX 7612 3D | Oceľová zárubňa    |            |
| VX 7521 3D | Hliníková zárubňa  |            |

**Prekrytie púzdra závesu**

| Séria   | Typ                    | Prekrytie |
|---------|------------------------|-----------|
| VX 25.. | VX 2560 KK, RK, KR, RR | Uhlové    |
|         | VX 2560 BRONZ KK       | Uhlové    |
|         | VX 2570 KK, RK         | Uhlové    |
|         | VX 2580                | Ploché    |
| VX 75.. | VX 7560 KK, RK, KR, RR | Uhlové    |
|         | VX 7570 KK, RK         | Uhlové    |
|         | VX 7580                | Ploché    |
|         | VX 7590                | Ploché    |

## 4.5 POSUNÉ SYSTÉMY NA DREVENÉ DVERE

Na vyžiadanie vám radi zašleme samostatný katalóg kovania na posuvné dvere.

### KOVANIE SF-35, SF-40

| Typ   | Nosnosť  | Hrúbka dverí | Povrchová úprava | Obj. číslo |
|-------|----------|--------------|------------------|------------|
| SF-35 | do 35 kg | od 27 mm     | Nikel            | 99-003500  |
| SF-40 | do 40 kg | od 27 mm     | Nikel            | 99-004000  |

### PROFIL HLINÍKOVÝ

| Typ           | Dĺžka | Povrchová úprava | Obj. číslo |
|---------------|-------|------------------|------------|
| Horný         | 2 m   | Zinok            | 99-3575    |
| Horný         | 3 m   | Zinok            | 99-0246    |
| Vodiaci prvok |       | Plast čierny     | 99-003554  |

### KOVANIE SF-65, SF-75

| Typ   | Nosnosť  | Hrúbka dverí | Povrchová úprava | Obj. číslo |
|-------|----------|--------------|------------------|------------|
| SF-65 | do 65 kg | od 27 mm     | Nikel            | 99-006500  |
| SF-75 | do 75 kg | od 27 mm     | Nikel            | 99-007500  |

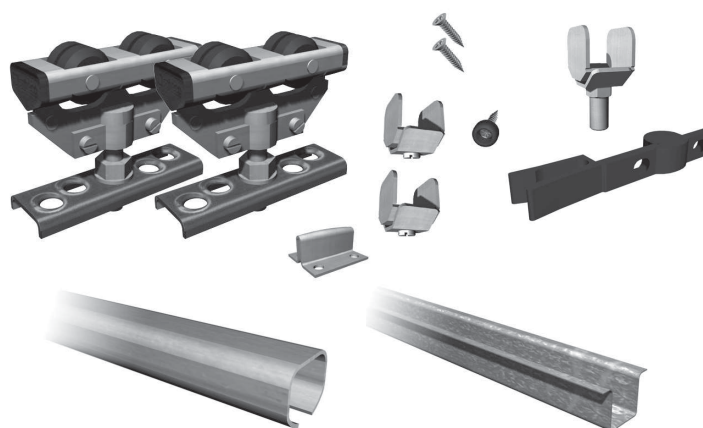
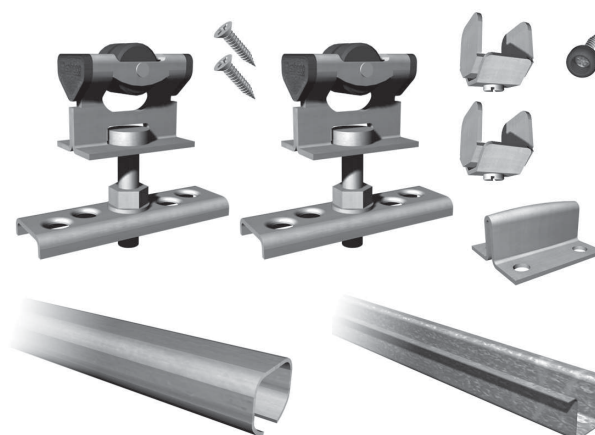

## 4.6 POSUNÉ SYSTÉMY NA SKLENENÉ DVERE

### KOVANIE SV-40, SV-75

| Typ   | Nosnosť  | Hrúbka dverí | Povrchová úprava | Obj. číslo |
|-------|----------|--------------|------------------|------------|
| SV-40 | do 40 kg | 8 - 10 mm    | Nikel            | 99-004600  |
| SV-75 | do 75 kg | 8 - 10 mm    | Nikel            | 99-007600  |

### PROFIL HLINÍKOVÝ

| Typ   | Dĺžka | Povrchová úprava | Obj. číslo |
|-------|-------|------------------|------------|
| Horný | 2 m   | Hliník           | 99-004620  |

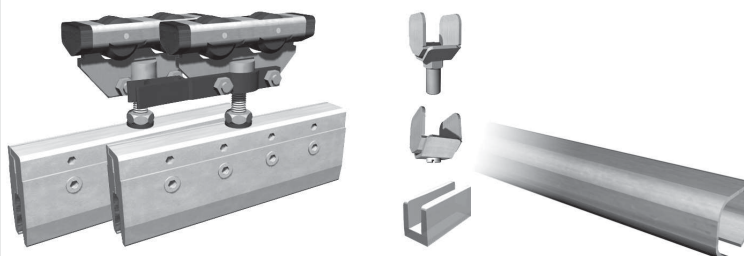
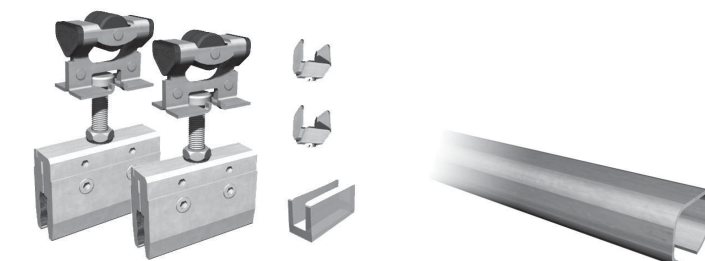

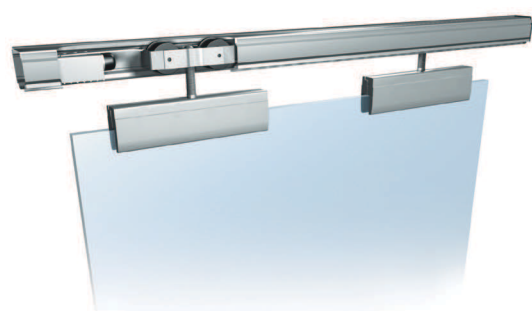
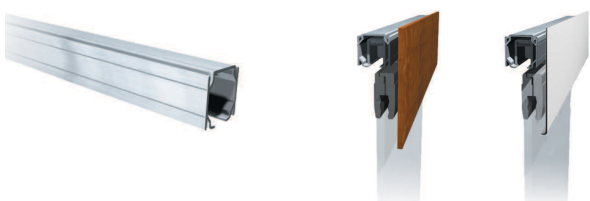
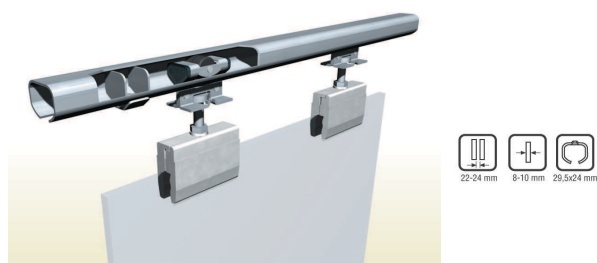
**KOVANIE SV-40, SV-75**

| Typ   | Nosnosť  | Hrúbka dverí | Povrchová úprava | Obj. číslo |
|-------|----------|--------------|------------------|------------|
| SV-40 | do 40 kg | 8 - 10 mm    | Nikel            | 99-004600  |
| SV-75 | do 75 kg | 8 - 10 mm    | Nikel            | 99-007600  |

**PROFIL HLINÍKOVÝ**

| Typ      | Dĺžka | Povrchová úprava | Obj. číslo |
|----------|-------|------------------|------------|
| SV-40/75 | 2 m   | Hliník           | 99-004620  |
| SV-40/75 | 3 m   | Hliník           | 99-004503  |

**KOVANIE SV-A60, SV-A80**

| Typ    | Nosnosť  | Hrúbka dverí | Povrchová úprava | Obj. číslo |
|--------|----------|--------------|------------------|------------|
| SV-A60 | do 60 kg | 8 - 10 mm    | Nikel            | 99-006600  |
| SV-A80 | do 80 kg | 8 - 10 mm    | Nikel            | 99-008600  |

**PROFIL HLINÍKOVÝ**

| Typ    | Dĺžka | Povrchová úprava | Obj. číslo |
|--------|-------|------------------|------------|
| SV-A80 | 2 m   | Hliník           | 99-006621  |
| SV-A80 | 3 m   | Hliník           | 99-006631  |
| SV-A80 | 5 m   | Hliník           | 99-006651  |

**PROFIL VODIACI**

| Typ       | Dĺžka | Povrchová úprava | Obj. číslo |
|-----------|-------|------------------|------------|
| AV-A60/80 | 2 m   | Hliník           | 99-006320  |
| AV-A60/80 | 3 m   | Hliník           | 99-006330  |

**LIŠTA KRYCIA**

| Typ       | Dĺžka | Povrchová úprava | Obj. číslo |
|-----------|-------|------------------|------------|
| SV-A60/80 | 2 m   | Hliník           | 99-006420  |
| SV-A60/80 | 3 m   | Hliník           | 99-006430  |
| SV-A60/80 | 5 m   | Hliník           | 99-006450  |

**KOVANIE SV-A100, SV-A125**

| Typ     | Nosnosť   | Hrúbka dverí | Povrchová úprava | Obj. číslo |
|---------|-----------|--------------|------------------|------------|
| SV-A100 | do 100 kg | 8 - 12 mm    | Nikel            | 99-011600  |
| SV-A125 | do 125 kg | 8 - 12 mm    | Nikel            | 99-012600  |

**PROFIL HLINÍKOVÝ**

| Typ     | Dĺžka | Povrchová úprava | Obj. číslo |
|---------|-------|------------------|------------|
| SV-A125 | 2 m   | Hliník           | 99-012621  |
| SV-A125 | 3 m   | Hliník           | 99-012631  |
| SV-A125 | 5 m   | Hliník           | 99-012651  |

**PROFIL VODIACI**

| Typ      | Dĺžka | Povrchová úprava | Obj. číslo |
|----------|-------|------------------|------------|
| SV-A100F | 2 m   | Hliník           | 99-010320  |
| SV-A100F | 3 m   | Hliník           | 99-010330  |

**LIŠTA KRYCIA**

| Typ          | Dĺžka | Povrchová úprava | Obj. číslo |
|--------------|-------|------------------|------------|
| SV-A100F/125 | 2 m   | Hliník           | 99-010420  |
| SV-A100F/125 | 3 m   | Hliník           | 99-010430  |
| SV-A100F/125 | 5 m   | Hliník           | 99-010450  |



## 4.7 ZNÍŽENÉ VOZÍKY NA DREVENÉ DVERE

### KOVANIE SF-A60, SF-A80

| Typ    | Nosnosť  | Hrúbka dverí | Povrchová úprava | Obj. číslo |
|--------|----------|--------------|------------------|------------|
| SF-A60 | do 60 kg | od 27 mm     | Nikel            | 99-006000  |
| SF-A80 | do 80 kg | od 27 mm     | Nikel            | 99-008000  |

### PROFIL HLINÍKOVÝ

| Typ           | Dĺžka | Povrchová úprava | Obj. číslo |
|---------------|-------|------------------|------------|
| Horný         | 2 m   | Hliník           | 99-006120  |
| Horný         | 3 m   | Hliník           | 99-006130  |
| Vodiaci prvok |       | Plast čierny     | 99-003554  |
| Držiak 60/56  |       | Nikel            | 99-006056  |

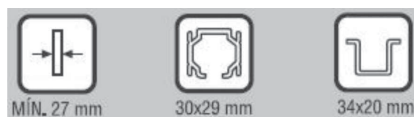
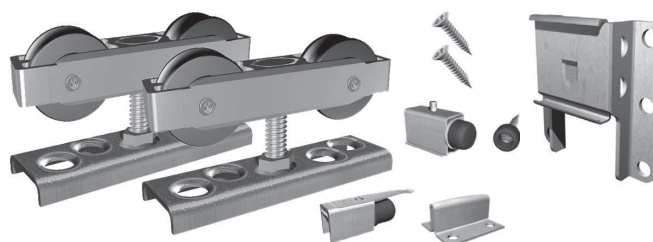

## 4.8 ZNÍŽENÉ VOZÍKY S MOŽNOSŤOU PREKRYTIA NAKLIKÁVACOU LIŠŤOU

### KOVANIE SV-A40F, SV-A60F, SV-A80F

| Typ     | Nosnosť  | Hrúbka dverí | Povrchová úprava | Obj. číslo |
|---------|----------|--------------|------------------|------------|
| SV-A40F | do 40 kg | 8 - 10 mm    | Nikel            | 99-005600  |
| SV-A60F | do 60 kg | 8 - 10 mm    | Nikel            | 99-006600  |
| SV-A80F | do 80 kg | 8 - 10 mm    | Nikel            | 99-008600  |

### PROFIL HLINÍKOVÝ

| Typ   | Dĺžka | Povrchová úprava | Obj. číslo |
|-------|-------|------------------|------------|
| Horný | 2 m   | Hliník           | 99-006620  |

### PROFIL KRYCÍ HLINÍKOVÝ

| Typ          | Dĺžka | Povrchová úprava | Obj. číslo |
|--------------|-------|------------------|------------|
| Vodidlo      | 0,1 m | Hliník           | 99-006301  |
| Profil nosný | 2 m   | Hliník           | 99-006320  |
| Lišta krycia | 2 m   | Hliník           | 99-006430  |
| Lišta krycia | 2 m   | Biela            | 99-006431  |
| Roh lišty    |       | Hliník           | 99-006302  |

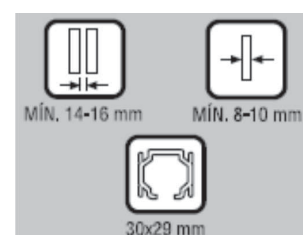
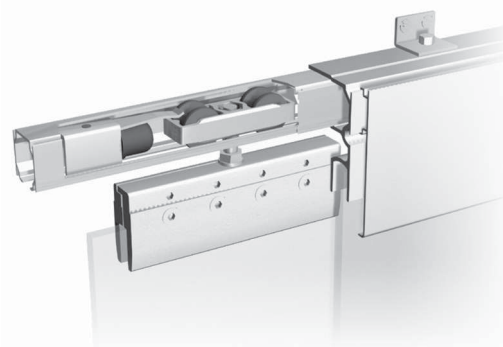

#### 4.9 SYSTÉMY NA DREVENÉ A SKLENENÉ DVERE



##### KOVANIE SF-I120 NA DREVENÉ DVERE

| Typ     | Nosnosť   | Hrúbka dverí | Povrchová úprava | Obj. číslo |
|---------|-----------|--------------|------------------|------------|
| SF-I120 | do 120 kg | 30 mm        | Antikoro         | 99-012100  |

##### PROFIL OCEĽOVÝ

| Typ   | Dĺžka | Povrchová úprava | Obj. číslo |
|-------|-------|------------------|------------|
| Horný | 2 m   | Antikoro         | 99-012020  |

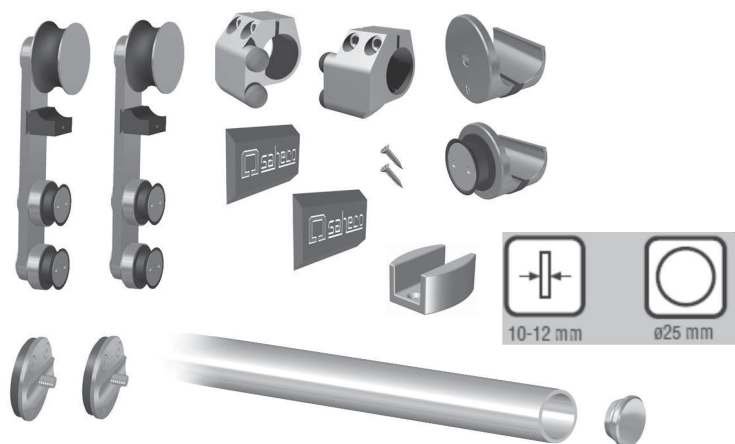

##### KOVANIE SV-I120 NA SKLENENÉ DVERE

| Typ     | Nosnosť   | Hrúbka dverí | Povrchová úprava | Obj. číslo |
|---------|-----------|--------------|------------------|------------|
| SV-I120 | do 120 kg | 10 - 12 mm   | Antikoro         | 99-012000  |

#### 4.10 POSUVNO-PARKOVACIE SYSTÉMY

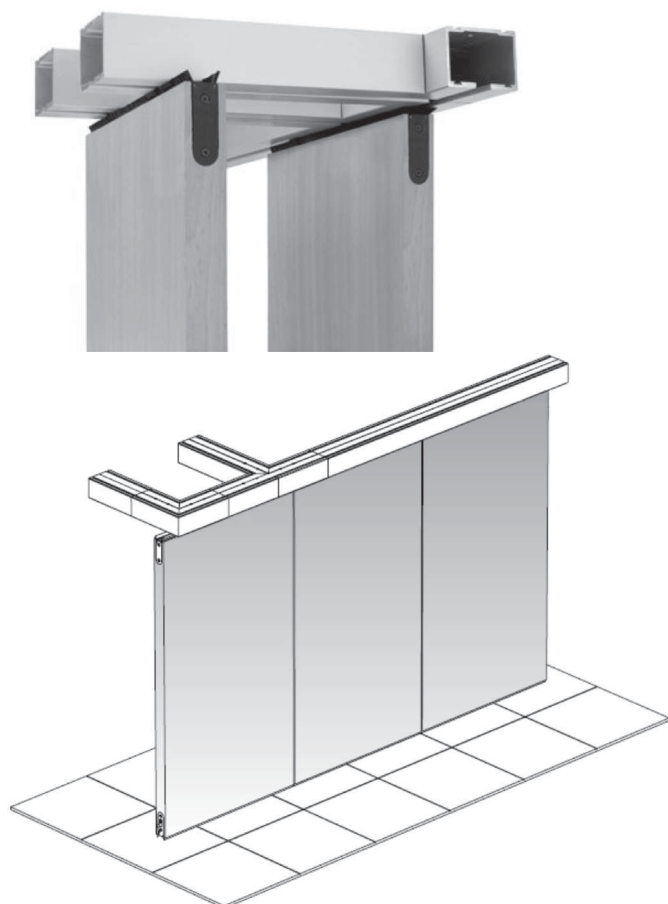

##### KOVANIE SF-P150 NA DREVENÉ DVERE\*

| Typ     | Nosnosť   | Hrúbka dverí | Povrchová úprava | Obj. číslo |
|---------|-----------|--------------|------------------|------------|
| SF-P150 | do 150 kg | od 45 mm     | Hliník           |            |

\* Technické riešenie: ☎ twd-dispečing

**KOVANIE SF-P250 NA DREVENÉ DVERE\***

| Typ     | Nosnosť   | Hrúbka dverí | Povrchová úprava | Obj. číslo |
|---------|-----------|--------------|------------------|------------|
| SF-P250 | do 250 kg | od 45 mm     | Hliník           |            |

\* Technické riešenie: ☎ twd-dispečing

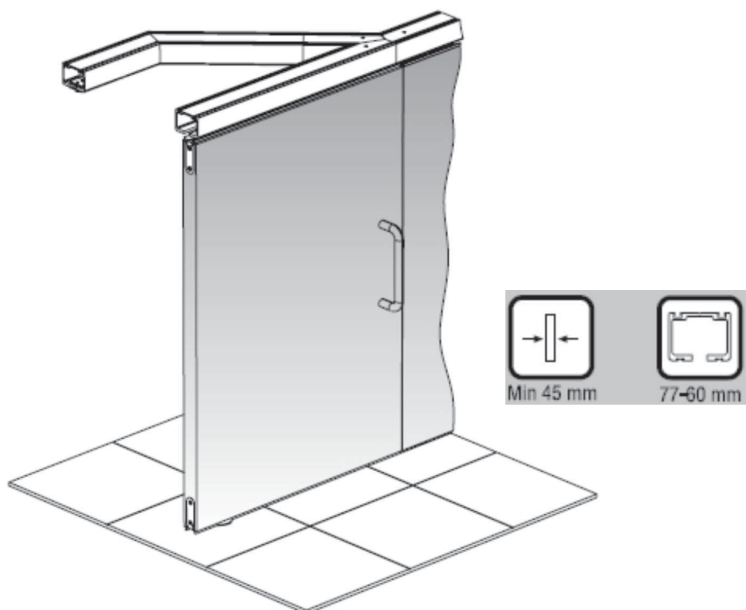
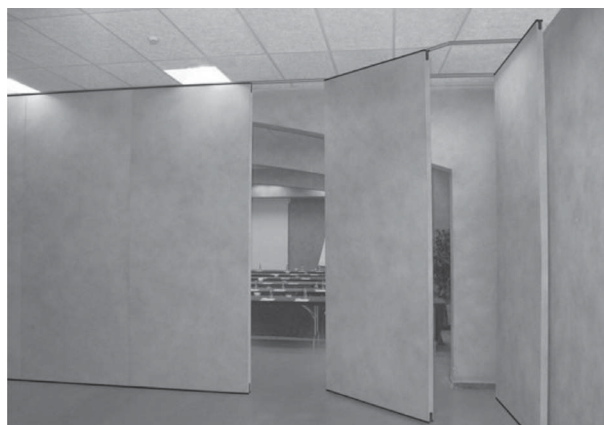

**KOVANIE SV-P150 NA SKLENENÉ DVERE\***

| Typ     | Nosnosť   | Hrúbka dverí | Povrch. úprava | Obj. číslo |
|---------|-----------|--------------|----------------|------------|
| SV-P150 | do 150 kg | 10 - 12 mm   | Hliník         |            |

\* Technické riešenie: ☎ twd-dispečing

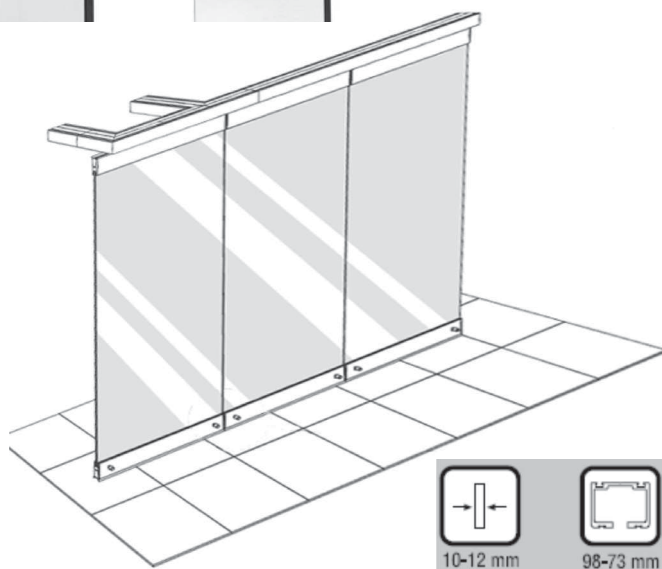

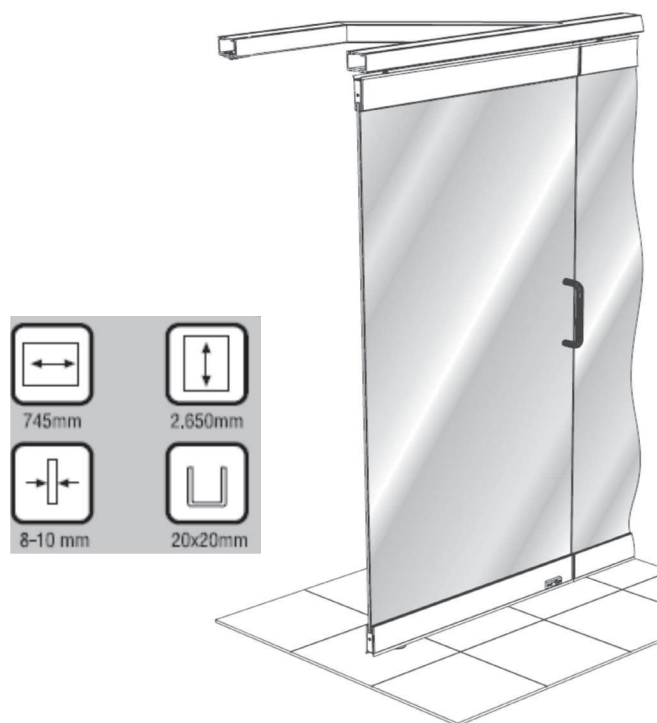
**KOVANIE SV-P250 NA SKLENENÉ DVERE\***

| Typ     | Nosnosť   | Hrúbka dverí | Povrch. úprava | Obj. číslo |
|---------|-----------|--------------|----------------|------------|
| SV-P250 | do 250 kg | 8 - 10 mm    | Hliník         |            |

\* Technické riešenie: ☎ twd-dispečing

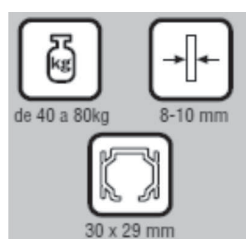
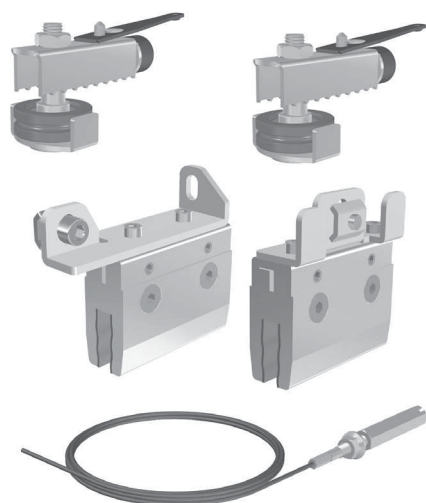
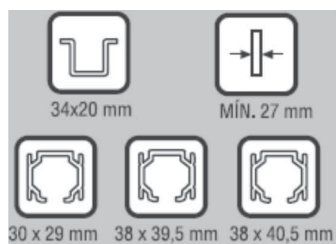
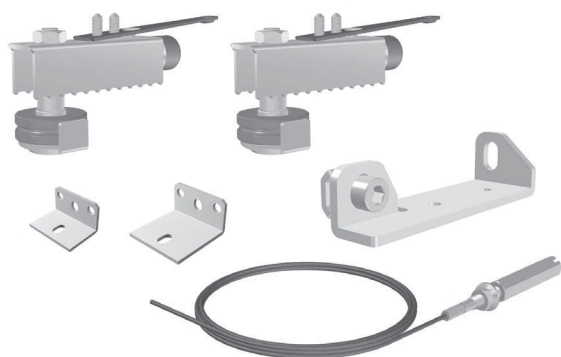
**4.11 SYSTÉMY PRE SÚČASNÝ POHYB OBOCH KRÍDEL**

**KOVANIE SF-SINCRO NA DREVENÉ DVERE  
na synchronne posúvanie dverí**

| Typ       | Nosnosť    | Hrúbka dverí | Povrch. úprava | Obj. číslo |
|-----------|------------|--------------|----------------|------------|
| SF-SINCRO | 60-80 kg   | od 27 mm     | Hliník         | 99-010112  |
| SF-SINCRO | 100-125 kg | od 27 mm     | Hliník         | 99-010113  |

**KOVANIE SV-SINCRO NA SKLENENÉ DVERE  
na synchronne posúvanie dverí**

| Typ       | Nosnosť    | Hrúbka dverí | Povrch. úprava | Obj. číslo |
|-----------|------------|--------------|----------------|------------|
| SV-SINCRO | 40-80 kg   | 8 - 10 mm    | Hliník         | 99-010114  |
| SV-SINCRO | 100-125 kg | 8 - 10 mm    | Hliník         | 99-010115  |

## 4.12 SYSTÉMY PRE GARÁŽOVÉ BRÁNY

### KOVANIE SF-201

| Typ    | Nosnosť   | Hrúbka dverí | Povrchová úprava | Obj. číslo |
|--------|-----------|--------------|------------------|------------|
| SF-201 | do 300 kg | od 40 mm     | Zinok            | 99-020100  |

### PROFIL OCEĽOVÝ

| Typ   | Dĺžka | Povrchová úprava | Obj. číslo |
|-------|-------|------------------|------------|
| Horný | 3 m   | Zinok            | 99-030030  |
| Horný | 5 m   | Zinok            | 99-030050  |
| Dolný | 3 m   | Zinok            | 99-004130  |
| Dolný | 5 m   | Zinok            | 99-004150  |

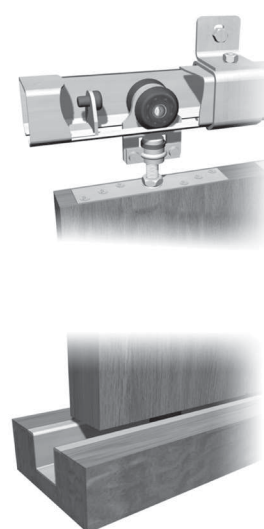

### KOVANIE SF-401

| Typ    | Nosnosť   | Hrúbka dverí | Povrchová úprava | Obj. číslo |
|--------|-----------|--------------|------------------|------------|
| SF-401 | do 600 kg | od 40 mm     | Zinok            | 99-040100  |

### PROFIL OCEĽOVÝ

| Typ   | Dĺžka | Povrchová úprava | Obj. číslo |
|-------|-------|------------------|------------|
| Horný | 3 m   | Zinok            | 99-030030  |
| Horný | 5 m   | Zinok            | 99-030050  |
| Dolný | 3 m   | Zinok            | 99-004130  |
| Dolný | 5 m   | Zinok            | 99-004150  |

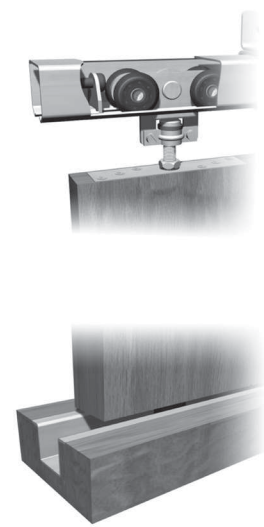

### KOVANIE SF-501

| Typ               | Nosnosť    | Hrúbka dverí | Povrch. úprava | Obj. číslo |
|-------------------|------------|--------------|----------------|------------|
| Vozík SF-501      | do 1000 kg | od 50 mm     | Zinok          | 99-050100  |
| Vodidlo kolajové  |            |              | Zinok          | 99-100169  |
| Vodidlo valčekové |            |              | Zinok          | 99-050171  |
| Doraz interiérový |            |              | Zinok          | 99-100170  |
| Doraz exteriérový |            |              | Zinok          | 99-100171  |

### PROFIL OCEĽOVÝ

| Typ   | Dĺžka | Povrchová úprava | Obj. číslo |
|-------|-------|------------------|------------|
| Horný | 5 m   | Zinok            | 99-100050  |
| Dolný | 5 m   | Zinok            | 99-100150  |



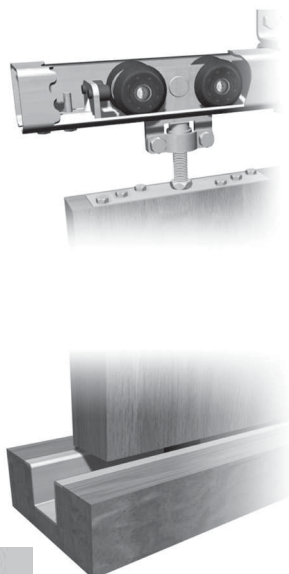

**KOVANIE SF-1000**

| Typ               | Nosnosť    | Hrúbka dverí | Povrch. úprava | Obj. číslo |
|-------------------|------------|--------------|----------------|------------|
| Vozík SF-1000     | do 2000 kg | od 50 mm     | Zinok          | 99-100100  |
| Vodidlo koľajové  |            |              | Zinok          | 99-100169  |
| Doraz interiérový |            |              | Zinok          | 99-100170  |
| Doraz exteriérový |            |              | Zinok          | 99-100171  |

**PROFIL OCEĽOVÝ**

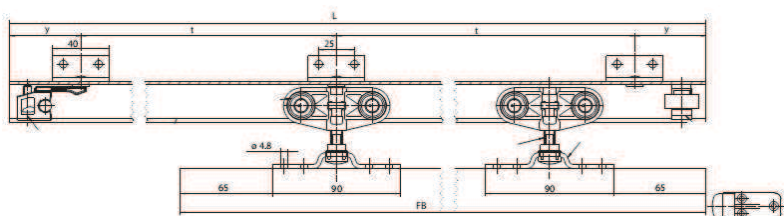
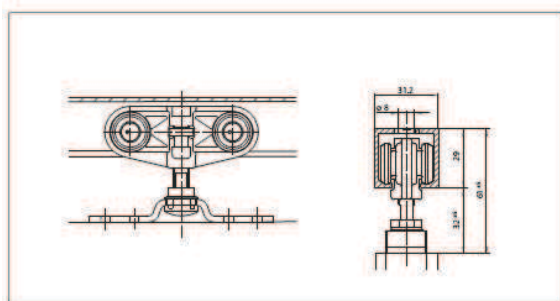
| Typ   | Dĺžka | Povrchová úprava | Obj. číslo |
|-------|-------|------------------|------------|
| Horný | 5 m   | Zinok            | 99-100050  |
| Dolný | 5 m   | Zinok            | 99-100150  |

**KOVANIE GEZE-ROLLAN 40N/80N**

- VÁHA DO 40KG ALEBO 80KG
- JEDNOKRÍDLOVÉ AJ DVOJKRÍDLOVÉ
- MONTÁŽ DO STROPU ALEBO NA STENU
- POVRCHOVA UPRAVA HLIŇÍK
- S MOŽNOSŤOU TLMENEHO DORAZU (SOFSTOP)
- DO ŠÍRKY 710-1700 mm
- POUŽITIE SKLO ALEBO DREVO
- POUŽITIE ZO ZAPUSTENÝMI NOSIČMI (DREVO)
- MOŽNOSŤ OSADIŤ KRYCÍM PROFILOM

| Typ                                      | Obj. číslo |
|--|------------|
| GZ-ROLLAN,40/80,ARETÁCIA KOVOVÁ          | 54-101887  |
| GZ-ROLLAN,40/80,DORAZ,GUMENÝ,R1e         | 54-102127  |
| GZ-ROLLAN,40/80,DORAZ+ARET/PLAST         | 54-102421  |
| GZ-ROLLAN,40/80,DRŽIAK SKLA,EV-1,SADA    | 54-102422  |
| GZ-ROLLAN,40/80,KO?AJNICA,6M             | 54-102423  |
| GZ-ROLLAN,40/80,PODL.NOSNÁ,R1/2          | 54-102445  |
| GZ-ROLLAN,40/80,UHOLNÍK MONTÁŽNY         | 54-102446  |
| GZ-ROLLAN,40/80,VODÍTKO,NA SKLO,8-10mm   | 54-102447  |
| GZ-ROLLAN,40/80,VODÍTKO,STANDART         | 54-102454  |
| GZ-ROLLAN,40N,131-150CM,+UHOL,SADA,2800  | 54-102455  |
| GZ-ROLLAN,40N,81-100CM,+UHOL,SADA,1800   | 54-102456  |
| GZ-ROLLAN,40N,91-110CM,+UHOL,SADA,1900   | 54-102789  |
| GZ-ROLLAN,40N,S-STOP,JED,KRÁTKY,555-800  | 54-102790  |
| GZ-ROLLAN,40N,S-STOP,OBOJ,STRED,880-1270 | 54-102791  |
| GZ-ROLLAN.40,VOZÍK+SKRUTKA               | 54-102862  |
| GZ-ROLLAN.80,VOZÍK+SKRUTKA               | 54-103086  |

**KOVANIE GEZE-LEVELAN**

- PRE SKLENENÉ POSUVNÉ DVERE (SKLO 8,10,12mm)
- VÁHA DO 150KG
- JEDNOKRÍDLOVÉ AJ DVOJKRÍDLOVÉ
- MONTÁŽ S FIXOM
- MONTÁŽ DO STROPU ALEBO NA STENU
- POVRCHOVÁ ÚPRAVA HLINÍK ALEBO VZHĽAD UŠLACHTILEJ OCELE
- S MOŽNOSŤOU TLMENÉHO DORAZU (SOFSTOP)
- DO ŠÍRKY 710-1300mm

| Typ   | Obj. číslo |
|---|------------|
| GZ-LEVELAN,KEFKA 2050MM,                          | 54-131787  |
| GZ-LEVELAN,KONCOVKA "U" PROFILU, HLINÍK           | 54-128294  |
| GZ-LEVELAN,PROFIL PEVNEJ STENY,REZANY, HLINÍK     | 54-006666  |
| GZ-LEVELAN,PROFIL PEVNEJ STENY,6M, HLINÍK         | 54-129272  |
| GZ-LEVELAN,PROFIL PRECHODU,REZANY, HLINÍK         | 54-007432  |
| GZ-LEVELAN,PROFIL PRECHODU,6M, HLINÍK             | 54-129277  |
| GZ-LEVELAN,PROFIL SPODNY "U" ,REZANY, HLINÍK      | 54-008481  |
| GZ-LEVELAN,PROFIL SPODNY "U" ,6M, HLINÍK          | 54-126966  |
| GZ-LEVELAN,PROFIL VOD, FIX+POSUV,REZANY, HLINÍK   | 54-008483  |
| GZ-LEVELAN,PROFIL VOD, FIX+POSUV,6M, HLINÍK       | 54-129141  |
| GZ-LEVELAN,SOFSTOP-OBOJST.SADA,976-1365,          | 54-008507  |
| GZ-LEVELAN,SPODNÉ VEDENIE NA SKLO, HLINÍK         | 54-120417  |
| GZ-LEVELAN, TESNENIE "U" PROFILU,12M,             | 54-126869  |
| GZ-LEVELAN,UCHYTKA FIX.PROFILU,20KS,STRO,         | 54-129033  |
| GZ-LEVELAN,KONCOVKA PROFIL VOD, FIX+POSUV, HLINÍK | 54-129874  |
| GZ-LEVELAN,DORAZ S ARETACIOV POLOHY 2KS SADA,     | 54-129222  |
| GZ-LEVELAN,VOZÍKY,2KS,SADA,                       | 54-128874  |

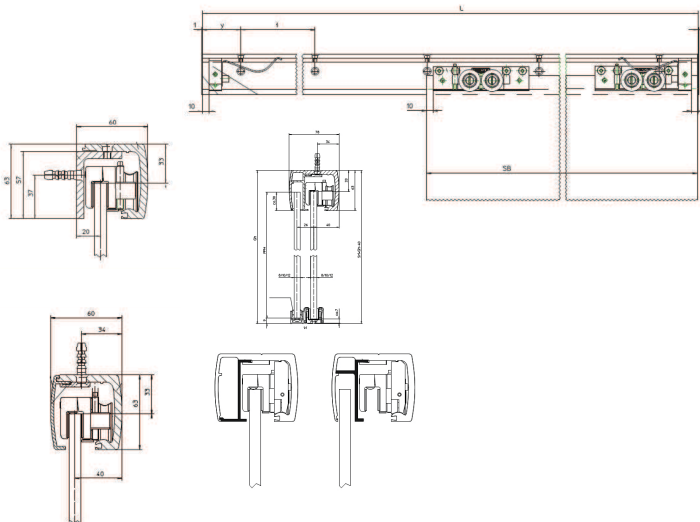
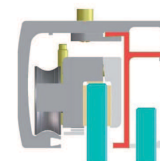
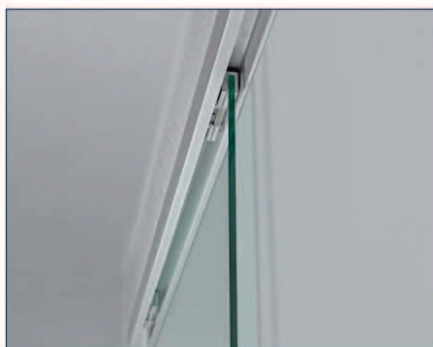

**KOVANIE GEZE-PERLAN 140**

- PERLAN KS (VONKAJŠIE POSUVNÉ OKENICE)
- VÁHA DO 140KG
- JEDNOKRÍDLOVÉ AJ DVOJKRÍDLOVÉ
- MONTÁŽ S FIXOM
- MONTÁŽ DO STROPU ALEBO NA STENU
- POVRCHOVÁ ÚPRAVA HLINÍK ALEBO VZHĽAD UŠLACHTILEJ OCELE
- S MOŽNOSŤOU TLMENÉHO DORAZU (SOFSTOP)
- DO ŠÍRKY 710-1700 mm
- POUŽITIE SKLO ALEBO DREVO
- POUŽITIE ZO ZAPUSTENÝMI NOSIČMI (DREVO)
- MOŽNOSŤ OSADIŤ KRYCÍM PROFILOM

| Typ   | Obj. číslo |
|---|------------|
| GZ-PERLAN,140,ARETÁCIA KOVOVÁ,                  | 54-016592  |
| GZ-PERLAN,140,DORAZ DO OMEGA PROFILU,           | 54-020015  |
| GZ-PERLAN,140,KO?AJ,6M,AL, HLINÍK               | 54-020835  |
| GZ-PERLAN,140,KO?AJ,6M,EV1,SOFSTOPOVA, HLINÍK   | 54-020836  |
| GZ-PERLAN,140,KO?AJ,6M,NER,SOFSTOPOVA, NEREZ    | 54-020838  |
| GZ-PERLAN,140,KONCOVKA PROFILU NE.EFEKT, NEREZ  | 54-020839  |
| GZ-PERLAN,140,L-PROFIL SP.100MM,                | 54-022718  |
| GZ-PERLAN,140,L-PROFIL SP.40MM,                 | 54-022720  |
| GZ-PERLAN,140,L-PROFIL,SP.60MM,                 | 54-022933  |
| GZ-PERLAN,140,MONT.ZAP.PLATNI?KA,               | 54-026291  |
| GZ-PERLAN,140,MONT.ZAP.PLATNI?KA,               | 54-026293  |
| GZ-PERLAN,140,PROFIL SP.OMEGA,6M, HLINÍK        | 54-026654  |
| GZ-PERLAN,140,PROFIL ZÁVESNÝ DRE.6M,EV1, HLINÍK | 54-026882  |
| GZ-PERLAN,140,PROFIL ZÁVESNÝ DRE.6M,NERE, NEREZ | 54-027333  |
| GZ-PERLAN,140,SKRUTKY NA SOF STOP,SADA,,        | 54-027335  |
| GZ-PERLAN,140,SOFTSTOP,JED.STREDNÝ,             | 54-027558  |
| GZ-PERLAN,140,SOFTSTOP,OBOJST,1290-1700,        | 54-027559  |
| GZ-PERLAN,140, TESNENIE, ST/PROF,BM,            | 54-027561  |
| GZ-PERLAN,140,VEDENIE L-PROFILU,                | 54-028348  |
| GZ-PERLAN,140,VOZÍK SET KS-NEREZ,51-170, NEREZ  | 54-028350  |

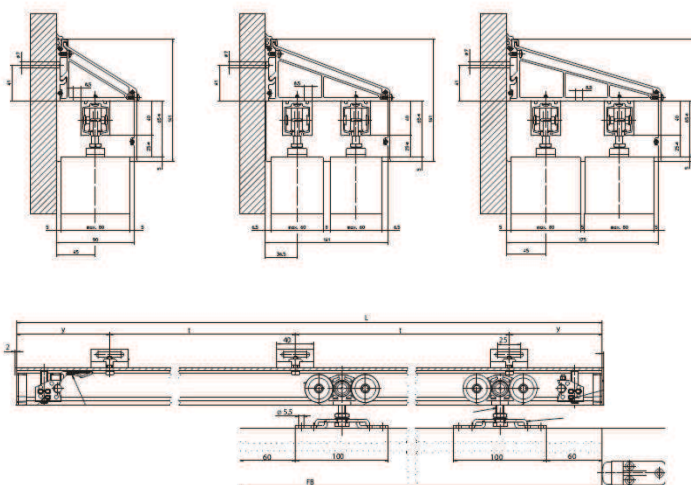

## 5.1 SAMOZATVÁRAČE



### SAMOZATVÁRAČ KABA DC C.680

|  |                       |
|--|-----------------------|
| max. rozmery dverí                     | 850 mm 950 mm 1100 mm |
| max. hmotnosť dverí                    | 40 kg 60 kg 80 kg     |
| použitelný vpravo a vľavo              |                       |
| Nastaviteľná sila zatvárania           | EN 2 EN 3 EN 4        |
| Rýchlosť zatvárania nastaviteľná       | 180° - 15°            |
| Rýchlosť koncového dorazu nastaviteľná | 15° - 0°              |
| Certifikáty                            | EN 1154               |
| Rameno                                 | Štandard              |
| Požiarne odolnosť CE                   | áno                   |

| Typ           | Povrchová úprava | Obj. číslo  |
|---------------|------------------|-------------|
| KABA DC C.680 | Biela            | 81-11770680 |
| KABA DC C.680 | Strieborná       | 81-11880680 |



### SAMOZATVÁRAČ KABA DC C.680

|  |            |
|--|------------|
| max. rozmery dverí                     | 950 mm     |
| max. hmotnosť dverí                    | 60 kg      |
| použitelný vpravo a vľavo              |            |
| Nastaviteľná sila zatvárania           | EN 3       |
| Rýchlosť zatvárania nastaviteľná       | 180° - 15° |
| Rýchlosť koncového dorazu nastaviteľná | 15° - 0°   |
| Certifikáty                            | EN 1154    |
| Rameno                                 | Štandard   |
| Požiarne odolnosť CE                   | ano        |

| Typ           | Povrchová úprava | Obj. číslo  |
|---------------|------------------|-------------|
| KABA DC C.702 | Biela            | 81-11770702 |
| KABA DC C.702 | Strieborná       | 81-11880702 |



**SAMOZATVÁRAČ TS 1000 C\***



| Typ                             | Obj. číslo |
|---------------------------------|------------|
| GZ-SZ TS1000C ZATVÁRAČ?+RAM,BL  | 54-118476  |
| GZ-SZ TS1000C ZATVÁRAČ?+RAM,BR  | 54-119510  |
| GZ-SZ TS1000C ZATVÁRAČ?+RAM,EV1 | 54-120021  |

\*balenie obsahuje samozatvárač aj rameno

**SAMOZATVÁRAČ TS 1500 C**



| Typ                               | Obj. číslo |
|-----------------------------------|------------|
| <b>TS 1500 V (SAMOSTATNÝ)</b>     |            |
| GZ-SZ TS1500 ZATVÁRAČ BEZ RAM.BL  | 54-122940  |
| GZ-SZ TS1500 ZATVÁRAČ BEZ RAM.BR  | 54-123511  |
| GZ-SZ TS1500 ZATVÁRAČ BEZ RAM.EV1 | 54-123512  |
| <b>KLZNÁ LIŠTA</b>                |            |
| GZ-SZ TS1500 LIŠTA KLZ.BL         | 54-120135  |
| GZ-SZ TS1500 LIŠTA KLZ.BR         | 54-120150  |
| GZ-SZ TS1500 LIŠTA KLZ.EV1        | 54-120161  |
| <b>RAMENO OBYČAJNÉ</b>            |            |
| GZ-SZ TS1500/1000 RAMENO,BI       | 54-123513  |
| GZ-SZ TS1500/1000 RAMENO,BR       | 54-123514  |
| GZ-SZ TS1500/1000,RAMENO,EV1      | 54-124640  |
| <b>RAMENO S ARETÁCIU</b>          |            |
| GZ-SZ TS1500 RAMENO+BLOK,BL       | 54-120287  |
| GZ-SZ TS1500 RAMENO+BLOK,BR       | 54-120417  |
| GZ-SZ TS1500 RAMENO+BLOK,EV1      | 54-120432  |
| <b>PODLOŽKA</b>                   |            |
| GZ-SZ TS1500 PODLOŽKA,BL          | 54-120164  |
| GZ-SZ TS1500 PODLOŽKA,BR          | 54-120165  |
| GZ-SZ TS1500 PODLOŽKA,EV1         | 54-120167  |

**SAMOZATVÁRAČ TS 2000 V**

| Typ       | Povrchová úprava | Obj. číslo |
|-----------|------------------|------------|
| TS 2000 V | Biela            | 54-103388  |
| TS 2000 V | Bronz            | 54-103387  |
| TS 2000 V | Strieborná       | 54-103386  |

**SAMOZATVÁRAČ S TLMENÍM OTVÁRANIA TS 2000 V BC**

| Typ          | Povrchová úprava | Obj. číslo |
|--------------|------------------|------------|
| TS 2000 V BC | Biela            | 54-103394  |
| TS 2000 V BC | Bronz            | 54-103393  |
| TS 2000 V BC | Strieborná       | 54-103392  |

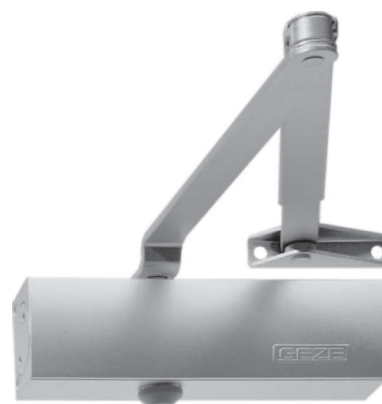

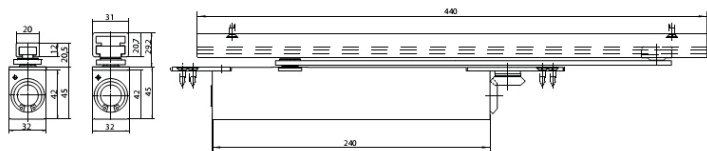
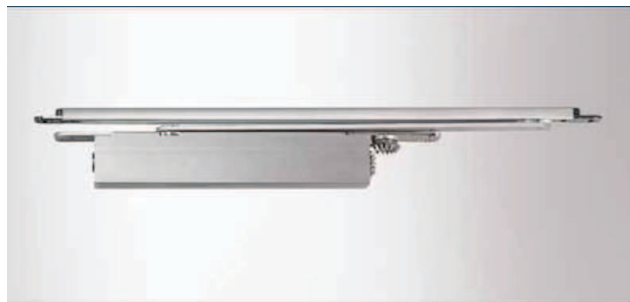
**TS 4000 V (SAMOSTATNÝ)**

| Typ                               | Obj. číslo |
|-----------------------------------|------------|
| GZ-SZ TS4000 ZATVÁRAČ BEZ RAM.BL  | 54-131211  |
| GZ-SZ TS4000 ZATVÁRAČ BEZ RAM.EV1 | 54-131215  |
| GZ-SZ TS4000 ZATVÁRAČ BEZ RAM.HN  | 54-131449  |

**PRÍSLUŠENSTVO K TS 2000V A TS 4000V**

| Typ                        | Povrchová úprava | Obj. číslo |
|----------------------------|------------------|------------|
| Rameno                     | Biela            | 54-102423  |
|                            | Bronz            | 54-102422  |
|                            | Strieborná       | 54-102421  |
| Rameno s aretáciou         | Biela            | 54-102456  |
|                            | Bronz            | 54-102455  |
|                            | Strieborná       | 54-102454  |
| Rameno s vyp/zap aretáciou | Biela            | 54-102447  |
|                            | Bronz            | 54-102446  |
|                            | Strieborná       | 54-102445  |
| Montážna platnička         | Biela            | 54-055756  |
|                            | Bronz            | 54-055756  |
|                            | Strieborná       | 54-055756  |

**SAMOZATVARAČ TS 3000 V  
SAMOZATVARAČ TS 5000 V**

| Typ                    | Povrchová úprava                   | Obj. číslo |
|------------------------|------------------------------------|------------|
| TS 3000 V (SAMOSTATNÝ) | GZ-SZ TS3000,ZATVÁRAČ BEZ RAM.BL   | 54-128660  |
|                        | GZ-SZ TS3000,ZATVÁRAČ BEZ RAM.EV1  | 54-128662  |
| TS 5000 V SAMOSTATNÝ)  | GZ-SZ TS5000 ZATVÁRAČ BEZ RAM.BL   | 54-135498  |
|                        | GZ-SZ TS5000 ZATVÁRAČ BEZ RAM.EV1  | 54-136585  |
| KLZNA LIŠTA            | GZ-SZ TS5/3000, LIŠTA KLZNÁ,BL     | 54-132872  |
|                        | GZ-SZ TS5/3000, LIŠTA KLZNÁ,EV1    | 54-135475  |
| DORAZ                  | GZ-SZ TS5/3000,DORAZ               | 54-132229  |
| BRZDA                  | GZ-SZ BRZDA DO KLZNEJ LIŠTY,TS5000 | 54-103393  |
| PODLOŽKA               | GZ-SZ TS3000, PODLOŽKA,EV1         | 54-128210  |

**BOXER 2/3 (SAMOSTATNÝ)**

| Typ                             | Obj. číslo                             |           |
|---------------------------------|--|-----------|
| BOXER 2-3 A KLZNA LIŠTA         | GZ-SZ BOXER 2-3, ZATVÁRAČ ZAPUSTENÝ    | 54-103387 |
|                                 | GZ-SZ BOXER LIŠTA KLZ. ZAPUSTENÁ       | 54-103392 |
| PRÍSLUŠENSTVO PENDLOVACIE DVERE | GZ-SZ BOXER LIŠTA KLZ. 2-4,PENDL,12MM  | 54-103388 |
|                                 | GZ-SZ,PENDL,SPODNÁ DVERNÁ LIŠTA,       | 54-137178 |
|                                 | GZ-SZ,PENDL,SPODNÝ OTOČ.ZAVES TS 137B  | 54-138015 |
|                                 | GZ-SZ,PENDL,SPODNÝ ZÁVES,KRYTKA        | 54-139384 |
|                                 | GZ-SZ,PENDL,VRCHNÝ OTOČ.ZAVES "C"/43mm | 54-141717 |

**PODLAHOVÝ SAMOTATVARAČ TS 500 EN3**

| Typ                         |  | Obj. číslo |
|-----------------------------|--|------------|
| TS 500 EN3                  | GZ-SZ SKLO, TS 500 EN3, ZATVÁRAČ DO PODLÁH | 54-115549  |
| PRÍSLUŠENSTVO SKLENNÉ DVERE | GZ-SZ SKLO, KRYTKA NA PODLAHOVÝ ZATVÁRAČ   | 54-111458  |
|                             | GZ-SZ SKLO, PT10, SPODNÝ PÁNT NA SKLO      | 54-111459  |
|                             | GZ-SZ SKLO, PT20, VRCHNÝ PÁNT NA SKLO      | 54-111460  |
|                             | GZ-SZ SKLO, PT24, OTOČNÝ BOD NA VRCH. PANT | 54-115385  |

**PÁKOVÝ MECHANIZMUS OL 90 N**

| Typ                        | Povrch. úprava                                 | Obj. číslo |
|----------------------------|--|------------|
| KRYTIE TYČE 6M             | GZ-PM OL90N KRYTIE TYČE, 6M, BL                | 54-030523  |
|                            | GZ-PM OL90N KRYTIE TYČE, 6M, BR                | 54-030611  |
|                            | GZ-PM OL90N KRYTIE TYČE, 6M, EV1               | 54-030612  |
| NOŽNICE ZATVÁRACIE         | GZ-PM OL90N NOŽNICE ZAMYK, BL                  | 54-030614  |
|                            | GZ-PM OL90N NOŽNICE ZAMYK., EV1                | 54-030615  |
|                            | GZ-PM OL90N NOŽNICE ZAMYK. BR                  | 54-030797  |
| PÁKA + ROHOVNÍK            | GZ-PM OL90N PÁKA+ROHOVNÍK, BL                  | 54-030811  |
|                            | GZ-PM OL90N PÁKA+ROHOVNÍK, BR                  | 54-030861  |
|                            | GZ-PM OL90N PÁKA+ROHOVNÍK, EV1                 | 54-030862  |
| PRÍSLUŠENSTVO K OL90       | GZ-PM OL90N ROHOVNÍK SAMOSTATNY                | 54-055756  |
|                            | GZ-PM OL90N PREVODNIK CEZ ROH, EV1             | 54-030971  |
|                            | GZ-PM OL90N, FLEXI ROH. VEDENIE-O              | 54-071924  |
|                            | GZ-PM OL90N, UNÁŠAČ KLZNÝ NA ŠIKME OKNO        | 54-101792  |
|                            | GZ-PM OL90N, UNÁŠAČ SAMOSTATNÝ                 | 54-101793  |
| TIAHLO PEVNÉ (TYČ) 6M      | GZ-PM OL90N TYČ ZAMYK, 6M, 8MM                 | 54-070546  |
|                            | GZ-PM OL90N SPOJKA TYČE, 8MM                   | 54-056951  |
| PRÍSLUŠENSTVO TYČ A TIAHLA | GZ-PM OL90N UNÁŠAČ SKR. ZATV, A11, 5           | 54-071354  |
|                            | GZ-PM OL90N, SPOJKA TIAHLA, SOLO, PLAST        | 54-101767  |
|                            | GZ-PM OL90N, VODÍTKO TIAHLA-O                  | 54-101794  |
|                            | GZ-PM, OL90N, SPOJKA KRYTIA, BIELA             | 54-101817  |
|                            | GZ-PM, OL90N, SPOJKA KRYTIA, ČIERNA            | 54-101878  |
| MOTOR                      | GZ-PM OL90N, MOTOR, E212/R1/230V, BIELY        | 54-074428  |
|                            | GZ-PM OL90N, MOTOR, E212/R1/230V, EV1          | 54-084955  |
|                            | GZ-PM OL90N, MOTOR, E212/R1/230V, RAL...       | 54-095137  |
|                            | GZ-PM OL90N, MOTOR, E212/R1/230V, TM. BRONZ    | 54-099245  |
| PREPÍNAČ K MOTORU          | GZ-PM OL90N, PREPÍNAČ, E33/230V, NÁST.         | 54-099728  |
|                            | GZ-PM OL90N, PREPÍNAČ, LTA-LSA, PODDOM         | 54-101765  |
| DIALKOVÉ OVLADANIE         | GZ-PM WHT-4 TLAČÍTKOVÝ VYSIELAČ                | 54-101815  |
|                            | GZ-PM WRM-230B, MODUL PRIJÍMACÍ, NA STENU      | 54-101816  |
| TIAHLA LANKOVE (BOVDEN)    | GZ-PM OL90N TIAHLO, 1000MM, BI                 | 54-063262  |
|                            | GZ-PM OL90N TIAHLO, 1000MM, HN                 | 54-068221  |
|                            | GZ-PM OL90N TIAHLO, 700MM, BI                  | 54-068627  |
|                            | GZ-PM OL90N TIAHLO, 700MM, BR                  | 54-069272  |
| PRÍSLUŠENSTVO K TIAHLU     | GZ-PM OL90N PRÍSLUŠ. K TIAHLU, BI              | 54-043546  |
|                            | GZ-PM OL90N PRÍSLUŠ. K TIAHLU, BR              | 54-048941  |
|                            | GZ-PM OL90N PRÍSLUŠ. K TIAHLU+PODL, HN         | 54-053262  |
|                            | GZ-PM OL90N PRÍSLUŠ. K TIAHLU+PODL, BL         | 54-054560  |
| OVLADANIE CEZ KLUKU        | GZ-PM OL90N ROHOVÝ PREVOD FZ90, L              | 54-055778  |
|                            | GZ-PM OL90N ROHOVÝ PREVOD FZ90, P              | 54-055779  |
|                            | GZ-PM OL90N TYČ PREVODU FZ45/27, BIELA         | 54-069274  |
|                            | GZ-PM OL90N TYČ PREVODU FZ45/27, EV1           | 54-069780  |
|                            | GZ-PM OL90N DRŽIAK KLUKY, BIELA                | 54-029722  |
|                            | GZ-PM OL90N DRŽIAK KLUKY, EV1                  | 54-030373  |
|                            | GZ-PM OL90N KLBOVÉ LOŽISKO, POZINK             | 54-030374  |
|                            | GZ-PM OL90N KLUKA KLBOVÁ, BIELA                | 54-030376  |
|                            | GZ-PM OL90N KLUKA KLBOVÁ, EV1                  | 54-030377  |
|                            | GZ-PM OL90N RÚRKA SPOJOVACIA, FZ45/27, L6M, EV | 54-103386  |



pre vertikálne osadené, dovnútra sklopné okná z dreva, plastu a kovu  
s výškou presahu 0 - 25mm  
Max. hmotnosť krídla 80kg  
Max. hmotnosť výplne 30kg/meter štvorcový  
malá spotreba miesta nad a vedľa krídla  
ľahké nastavenie prítlaču pri automatickom vyrovnávaní nepresností



## 5.2 PANIKOVÉ KOVANIE



### PANIKOVÉ KOVANIE MODEL T

- Ľahká inštalácia
- Variabilita a modulárnosť
- Pre jednokridlové aj dvojkridlové dvere
- Štandardné použitie do rozmeru dverí 900 x 2350 mm
- Rozširiteľné až do rozmeru 1200 x 3200 mm
- Jeden mechanizmus pre typ A aj B pri modeloch T aj R
- Výmenné elementy
- Možnosť prídania elementov do už namontovaného kovania

### PANIKOVÉ KOVANIE MODEL T - TYP A ovládanie tyčou

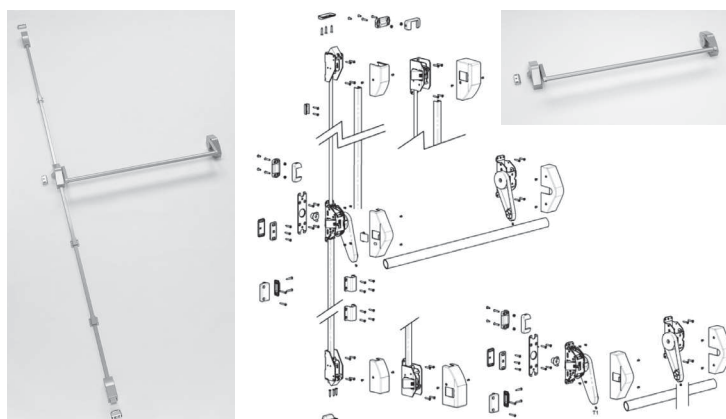

### PANIKOVÉ KOVANIE MODEL T - TYP B ovládanie tlačidlom

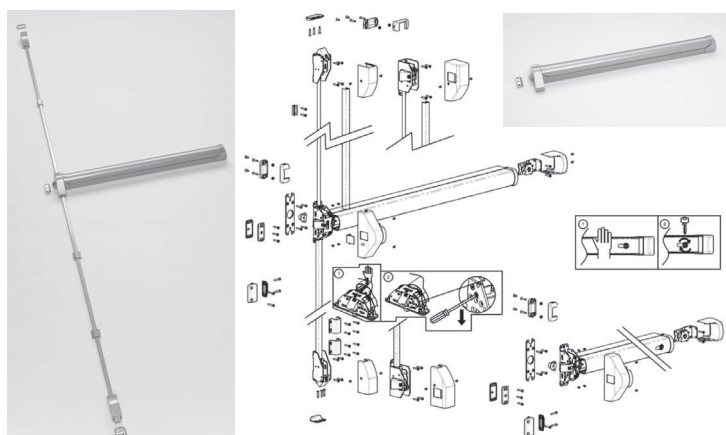

### PANIKOVÉ KOVANIE MODEL T - VONKAJŠIE KĽUČKY

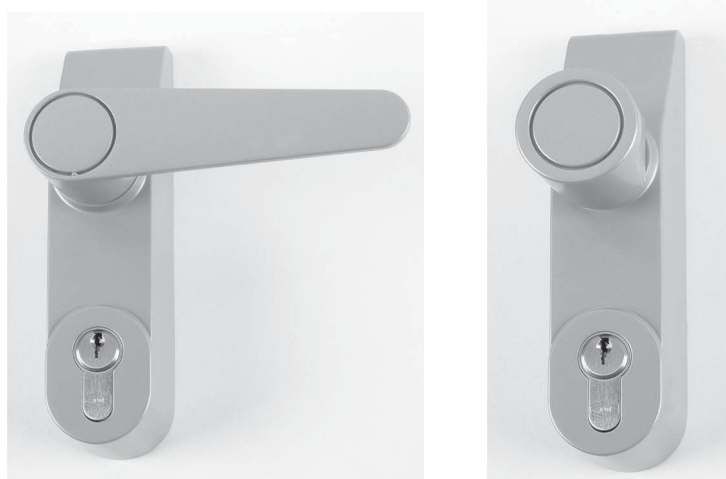

## 6.1 AUTOMATICKÉ SYSTÉMY



Požiadavky na moderné bývanie sú stále viac komplexnejšie. Záujem o možnosť energetickej úspory a o atraktívny dizajn stúpa aj u technických výrobkov. Tiež komfort bývania, bezpečnosť a možnosť elektronického zabezpečenia budov stále viac nadobúda na význame. Tu sú požadované ucelené riešenia, ktoré zodpovedajú tomuto veľkému množstvu rozdielnych aspektov.

Ako dodávateľ systémových riešení a kompletov dáva **SIEGENIA-AUBI** impulzy aj v technike pre budovy. Ponúka mnoho inteligentných a vzájomne zladených riešení pre kovanie, pohon, riadenie a vetranie na najvyššej úrovni. Tým zaručuje kvalitu života a bezpečnosť – od motoricky riadených a automaticky sa zatvárajúcich okien až po inteligentný zabezpečovací systém.

Reťazovým pohonom je možné tlačidlom, alebo diaľkovým ovládaním riadiť mnoho druhov okien.

Pohon ozubenou tyčou ponúka vysokú tlakovú a ťahovú stabilitu v každej montážnej situácii a je možné ho integrovať do dymových odsávacích zariadení.

S motorickou kľučkou **MH 10** sa inteligentné vetranie a vysoký komfort bývania stáva skutočnosťou.

400 kg je možné ovládať stisnutím tlačidla. Motorický posuvno-zdvíhací systém **MHS400** spoľahlivo otvára a zatvára automaticky posuvno-zdvíhacie elementy (HS-portály).



### BEZDRÔTOVÉ ZABEZPEČENIE FUNKSENSORIK



**FUNKSENSORIK** je bezdrôtový zabezpečovací systém pre okná a balkónové dvere. Dymový a plynový hlásič, vonkajšia siréna, telefonický prenos poplachu rovnako ako rad ďalších komponentov môžu byť individuálne zostavené a rádiový signál prispôbený potrebám zákazníka. Kompletným riešením je tak **FUNKSENSORIK** schopný rozsiahle zabezpečiť budovu zvonka aj zvnútra.

Pohľad do detailov ozrejmi mnohé výhody **FUNKSENSORIKU**:

- Disponuje jednoduchým programovaním a ľahkým ovládaním.
- Zabezpečovací okenný systém obsahuje včasné rozpoznanie pri násilnom otvorení a má tiež akustický hlásič rozbitia skla.
- Plynový a dymový hlásič spoľahlivo identifikujú často nerozpoznateľné dymové plyny pri požiari budov.
- Energeticky úsporný systém ukazuje stav otvorenia okien a dverí a pomáha efektívnemu využívaniu drahého tepla.
- Bezdrôtová montáž je čistá a rýchla a tým je **FUNKSENSORIK** ideálny aj pre dodatočnú inštaláciu.
- Prísne predpísaná rádiová frekvencia zaručuje bezpečnosť vysielania a bezporuchovú prevádzku.
- Blok batérií zaobstaráva núdzové napájanie.



**GEZE** ponúka pohony pre okná a dvere, posuvné, otváracie, alebo zalamovacie, bezbariérované, otočné (karusely), ktoré zároveň spĺňajú vysoké nároky na funkčnosť a estetiku. Sú použiteľné pre rámové alebo bezrámové dvere, s jednoduchým alebo izolačným zasklením, jednokrídlové, alebo dvojkrídlové dvere.

Systém riadi elektronika, ktorá spĺňa všetky požiadavky kladené na automatické riadenie a je možné ju napojiť na EPS alebo iný riadiaci systém budovy.

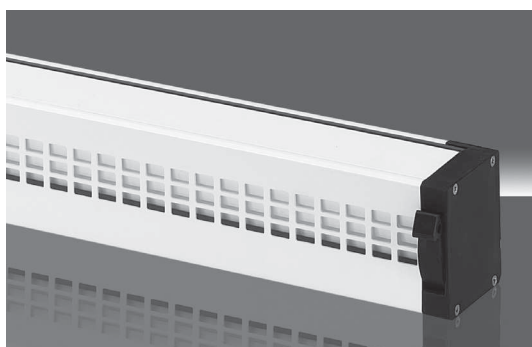

**7.1 VETRÁKY DO OBYTNÝCH MIESTNOSTÍ OKENNÉ**

**AEROMAT 80**

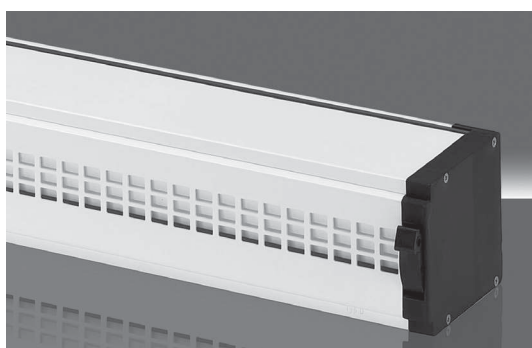
Plochý vetrák vyhovujúci potrebám výkonného vetrania a hlukového útlmu.

**AEROMAT 100**

Vetrák tlmíaci hluk na kontrolovaný prívod čerstvého vzduchu bez hlukového zaťaženia.

**AEROMAT 150**

Vetrák tlmíaci hluk s extra vysokým výkonom. Zvlášť vhodný pre kancelárie a administratívne budovy.

**AEROMAT VT**

Vetrák tlmíaci hluk určený na montáž pod parapet bez poškodenia fasády s možnosťou dovybavenia rekuperátorom na spätný zisk tepla. Prevádzka na 12 V.



## 7.2 VETRÁKY DO OBYTNÝCH MIESTNOSTÍ NÁSTENNÉ

### AEROVITAL®

Univerzálny vetrák s peľovým filtrom – jedinečné riešenie pre alergikov, účinnosť klinicky testovaná.



### AEROLIFE®

Nástenný vetrák na energeticky úsporné vetranie bez hlukového zaťaženia.



### AEROPAC®

Tichý vetrák na pokojný spánok s možnosťou filtrácie výfukových plynov.



### AEROPLUS®

Vhodný na automatické odvlhčovanie vlhkých miestností (kúpeľne) so zabudovaným výmenníkom tepla pre väčšiu úsporu energie.



- |  |                             |
|--|-----------------------------|
| S hlukovým útlmom                          | S peľovým filtrom           |
| Na bezpečné vetranie                       | S automatickým odvlhčovaním |
| So spätným získaním tepla                  | S filtrom z aktívneho uhlia |
| Pasívny vetrák alebo vybavený ventilátorom |                             |

### 7.3 VETRÁKY DO ZIMNÝCH ZÁHRAD

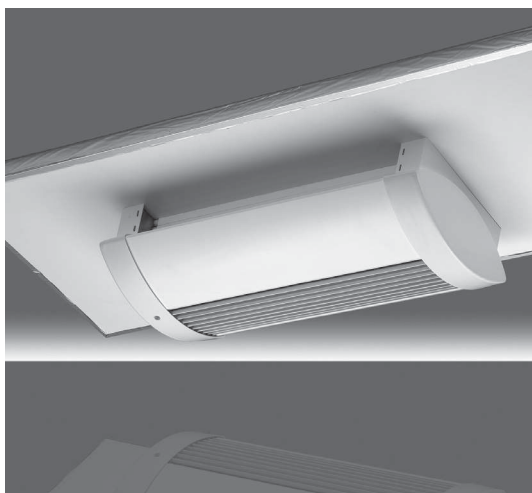
**AEROJET**

Vetrák s dažďovým senzom určený na odvetrávanie zimných záhrad. Montáž je možná na stenu aj na strechu.

**AEROSTAR**

Vetrák na odvetrávanie zimných záhrad s montážou na stenu alebo na strechu.

**AEROMAT 150.Z**

Vetrák na privetrávanie zimných záhrad s montážou na stenu.

**AEROTRONIC**

Riadiaca jednotka, ktorá sleduje podmienky prostredia a reguluje vetranie zimných záhrad.



## 8.1 ODKVAPOVÉ PROFILY RÁMOVÉ

### ODKVAPOVÝ PROFIL RÁMOVÝ SPREE 24 OF



| Povrchová úprava    | Obj. číslo |
|---------------------|------------|
| Biela               | 05-811268  |
| Bronz - G 214       | 05-811183  |
| Strieborná - EV 1   | 05-811138  |
| Tmavý bronz - G 216 | 05-811220  |

### KONCOVKA NA SPREE 24 OF

| Povrch. úprava | Typ  | Obj. číslo | Typ   | Obj. číslo |
|----------------|------|------------|-------|------------|
| Biela          | Ľavá | 05-255024  | Pravá | 05-355024  |
| Bronz          | Ľavá | 05-803478  | Pravá | 05-155024  |
| Strieborná     | Ľavá | 05-455024  | Pravá | 05-555024  |

### KONCOVKA ŠIKMÁ NA SPREE 24 OF

| Povrch. úprava | Typ  | Obj. číslo | Typ   | Obj. číslo |
|----------------|------|------------|-------|------------|
| Biela          | Ľavá | 05-951018  | Pravá | 05-951032  |
| Bronz          | Ľavá | 05-951094  | Pravá | 05-951131  |
| Strieborná     | Ľavá | 05-951056  | Pravá | 05-951070  |

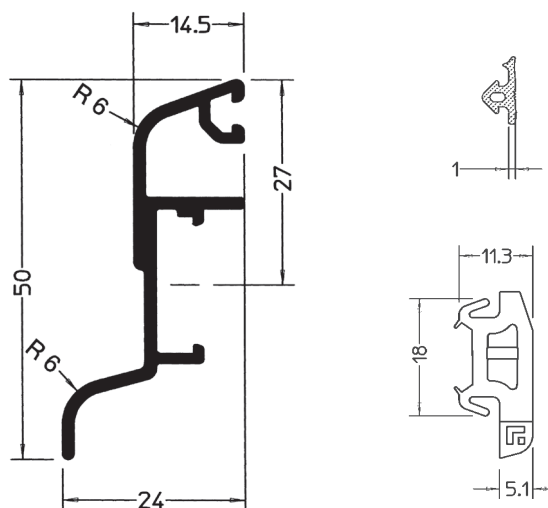

### ODKVAPOVÝ PROFIL RÁMOVÝ SPREE 27 OF



| Povrchová úprava  | Obj. číslo |
|-------------------|------------|
| Biela             | 05-850045  |
| Bronz - G 214     | 05-849964  |
| Strieborná - EV 1 | 05-849926  |

### KONCOVKA NA SPREE 27 OF

| Povrch. úprava | Typ  | Obj. číslo | Typ   | Obj. číslo |
|----------------|------|------------|-------|------------|
| Biela          | Ľavá | 05-842712  | Pravá | 05-842736  |
| Bronz          | Ľavá | 05-842798  | Pravá | 05-842811  |
| Strieborná     | Ľavá | 05-842750  | Pravá | 05-842774  |

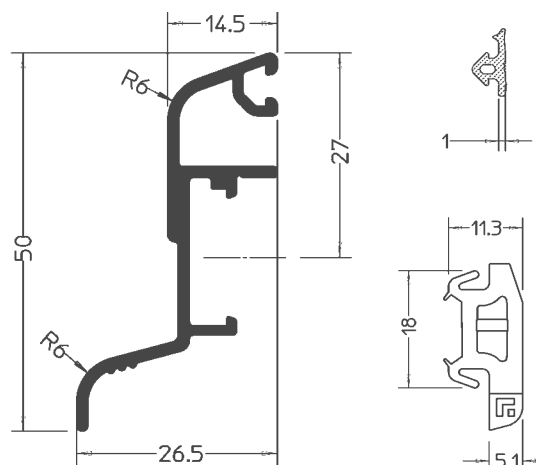

### ODKVAPOVÝ PROFIL RÁMOVÝ DRAU 25/24 F



| Povrchová úprava  | Obj. číslo |
|-------------------|------------|
| Biela             | 05-703327  |
| Bronz - G 214     | 05-703228  |
| Strieborná - EV 1 | 05-703143  |

### KONCOVKA ŠIKMÁ NA DRAU 25/24 F

| Povrch.úprava | Typ  | Obj. číslo | Typ   | Obj. číslo |
|---------------|------|------------|-------|------------|
| Biela         | Ľavá | 05-107941  | Pravá | 05-107958  |
| Bronz         | Ľavá | 05-107989  | Pravá | 05-107996  |
| Strieborná    | Ľavá | 05-107965  | Pravá | 05-107972  |

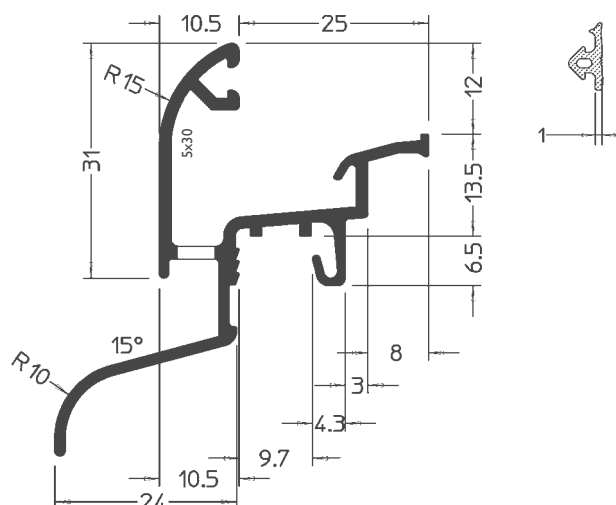

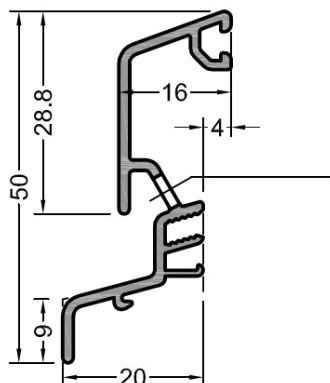
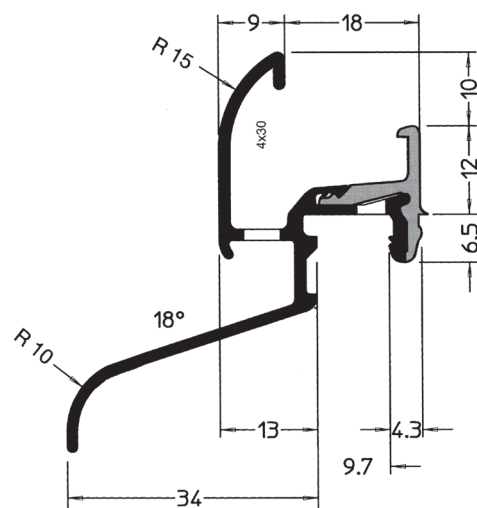
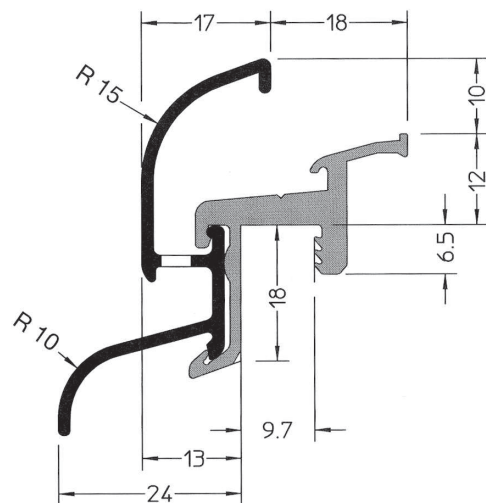
**ODKVAPOVÝ PROFIL RÁMOVÝ DONAU 22/24 F-TI**

| Povrchová úprava    | Obj. číslo |
|---------------------|------------|
| Biela               | 05-491705  |
| Bronz - G 214       | 05-491668  |
| Strieborná - EV 1   | 05-491644  |
| Tmavý bronz - G 216 | 05-491682  |

**KONCOVKA NA DONAU 22/24 F-TI**

| Povrch. úprava | Typ  | Obj. číslo | Typ   | Obj. číslo |
|----------------|------|------------|-------|------------|
| Biela          | Ľavá | 05-402401  | Pravá | 05-402411  |
| Bronz          | Ľavá | 05-402402  | Pravá | 05-402412  |

**KONCOVKA ŠIKMÁ NA DONAU 22/24 F-TI**

| Povrch. úprava | Typ  | Obj. číslo | Typ   | Obj. číslo |
|----------------|------|------------|-------|------------|
| Biela          | Ľavá | 05-494997  | Pravá | 05-495017  |
| Bronz          | Ľavá | 05-494928  | Pravá | 05-494942  |
| Strieborná     | Ľavá | 05-494881  | Pravá | 05-494904  |

**ODKVAPOVÝ PROFIL RÁMOVÝ NECKAR 22/34 F-TXL**

| Povrchová úprava  | Obj. číslo |
|-------------------|------------|
| Biela             | 05-755951  |
| Bronz - G 214     | 05-755913  |
| Strieborná - EV 1 | 05-755890  |

**KONCOVKA NA NECKAR 22/34 F-TXL**

| Povrch. úprava | Typ  | Obj. číslo | Typ   | Obj. číslo |
|----------------|------|------------|-------|------------|
| Biela          | Ľavá | 05-451340  | Pravá | 05-451341  |
| Bronz          | Ľavá | 05-450340  | Pravá | 05-450341  |

**KONCOVKA ŠIKMÁ NA NECKAR 22/34 F-TXL**

| Povrch. úprava | Typ  | Obj. číslo | Typ   | Obj. číslo |
|----------------|------|------------|-------|------------|
| Biela          | Ľavá | 05-731627  | Pravá | 05-731634  |
| Bronz          | Ľavá | 05-731672  | Pravá | 05-731689  |
| Strieborná     | Ľavá | 05-731658  | Pravá | 05-731641  |

**ODKVAPOVÝ PROFIL RÁMOVÝ SPREE-D 24OF**

| Povrchová úprava | Obj. číslo |
|------------------|------------|
| Bronz - G 214    | 05-861461  |

**KONCOVKA NA SPREE-D 24OF**

| Povrch. úprava | Typ  | Obj. číslo | Typ   | Obj. číslo |
|----------------|------|------------|-------|------------|
| Bronz          | Ľavá | 05-832553  | Pravá | 05-832577  |

## 8.2 ODKVAPOVÉ PROFILY KRÍDLOVÉ

### ODKVAPOVÝ PROFIL KRÍDLOVÝ FP 6257



| Povrchová úprava    | Obj. číslo |
|---------------------|------------|
| Biela               | 05-734499  |
| Bronz - G 214       | 05-734475  |
| Strieborná - EV 1   | 05-734468  |
| Tmavý bronz - G 216 | 05-734482  |

### KONCOVKA NA FP 6257

| Povrch. úprava | Typ  | Obj. číslo | Typ   | Obj. číslo |
|----------------|------|------------|-------|------------|
| Biela          | Ľavá | 05-132059  | Pravá | 05-132066  |
| Bronz          | Ľavá | 05-132110  | Pravá | 05-132127  |
| Strieborná     | Ľavá | 05-132073  | Pravá | 05-132103  |

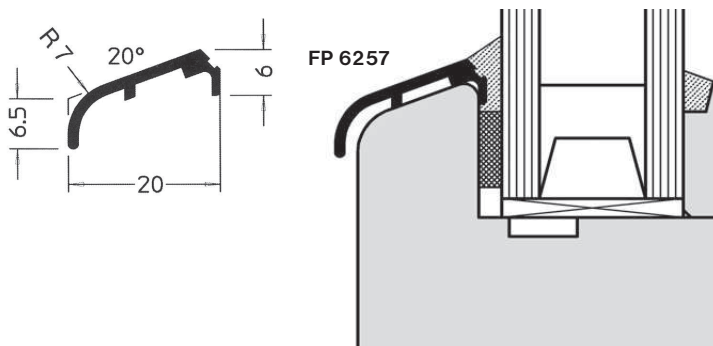

### ODKVAPOVÝ PROFIL KRÍDLOVÝ FP 8532



| Povrchová úprava    | Obj. číslo |
|---------------------|------------|
| Biela               | 05-734635  |
| Bronz - G 214       | 05-734611  |
| Strieborná - EV 1   | 05-733263  |
| Tmavý bronz - G 216 | 05-734628  |

### KONCOVKA NA FP 8532

| Povrch. úprava | Typ  | Obj. číslo | Typ   | Obj. číslo |
|----------------|------|------------|-------|------------|
| Biela          | Ľavá | 05-147244  | Pravá | 05-147237  |
| Bronz          | Ľavá | 05-147268  | Pravá | 05-147299  |
| Strieborná     | Ľavá | 05-147275  | Pravá | 05-147282  |

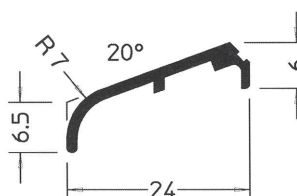

### ODKVAPOVÝ PROFIL KRÍDLOVÝ FP 8849



| Povrchová úprava | Obj. číslo |
|------------------|------------|
| Biela            | 05-734703  |
| Bronz            | 05-734680  |

### KONCOVKA NA FP 8849

| Povrch. úprava | Typ  | Obj. číslo | Typ   | Obj. číslo |
|----------------|------|------------|-------|------------|
| Biela          | Ľavá | 05-556343  | Pravá | 05-557343  |
| Bronz          | Ľavá | 05-556428  | Pravá | 05-556442  |

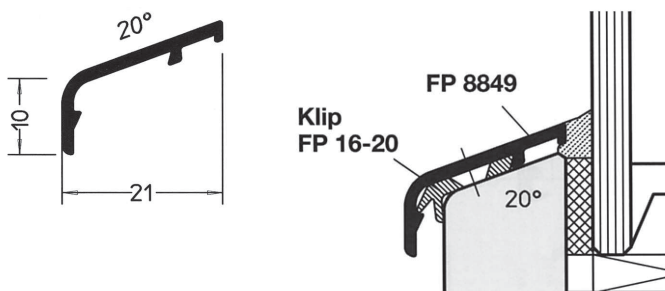

## 8.3 PRAHY DO VCHODOVÝCH DVERÍ

### DVEROVÝ PRAH WESER 108/32-TI\*



| Typ             | Šírka falca | Obj. číslo |
|-----------------|-------------|------------|
| WESER 108/32-TI | 47 - 52 mm  | 05-859987  |

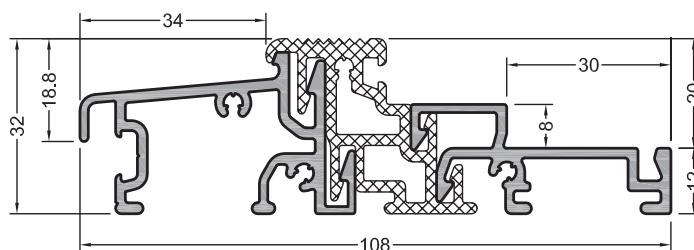

### DVEROVÝ PRAH WESER 102/32-TI\*



| Typ             | Šírka falca | Obj. číslo |
|-----------------|-------------|------------|
| WESER 102/32-TI | 41 - 46 mm  | 05-859680  |

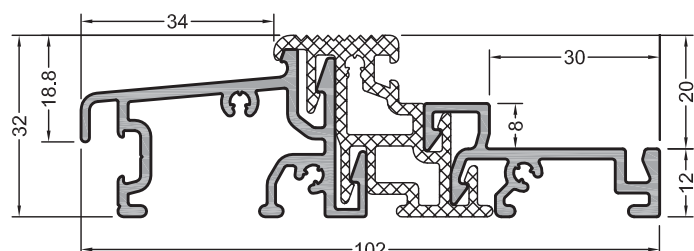

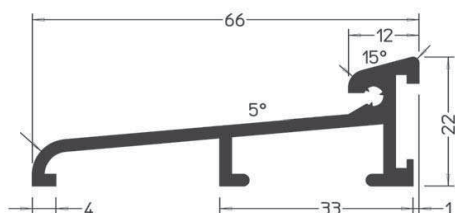
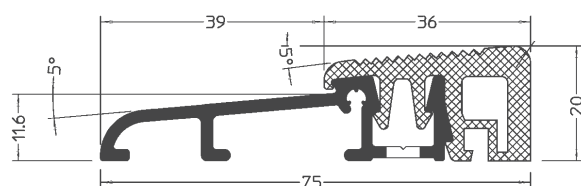
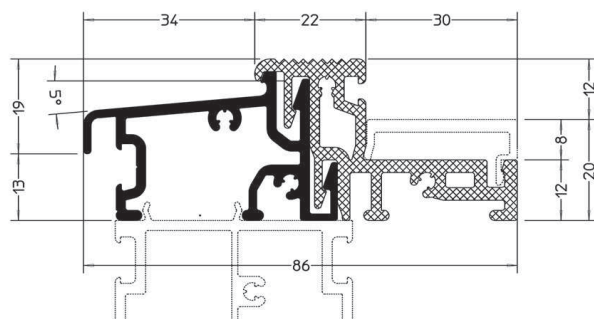
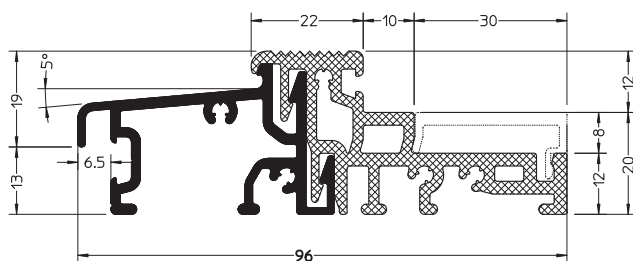
**DVEROVÝ PRAH WESER 96/32-TI**

| Typ            | Šírka falca | Obj. číslo |
|----------------|-------------|------------|
| WESER 96/32-TI | 35 - 40 mm  | 05-958413  |

**DVEROVÝ PRAH WESER 86/32-TI**

| Typ            | Šírka falca | Obj. číslo |
|----------------|-------------|------------|
| WESER 86/32-TI | 25 - 30 mm  | 05-900487  |

**DVEROVÝ PRAH WESER 75-TI**

| Typ         | Farba  | Obj. číslo |
|-------------|--------|------------|
| WESER 75-TI | EV 1   | 05-130741  |
| WESER 75-TI | surový | 05-130758  |

**DVEROVÝ PRAH WESER 66**

| Typ      | Obj. číslo |
|----------|------------|
| WESER 66 | 05-043737  |

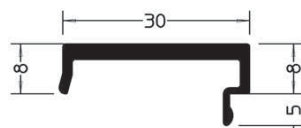
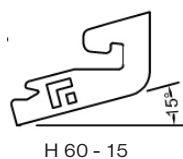
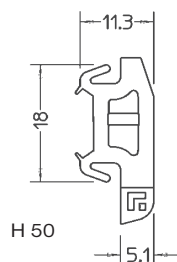
**8.4 PRÍSLUŠENSTVO**

**DŽIAK ODKVAPOVÉHO PROFILU SPREE 24 OF**

| Typ       | Obj. číslo |
|-----------|------------|
| H 50      | 05-812166  |
| H 60 - 15 | 05-488660  |

**TESNENIE ODKVAPOVÝCH PROFILOV  
SPREE 24 OF, DRAU 25/24 F**

| Typ     | Obj. číslo |
|---------|------------|
| D 190 F | 05-118626  |
| D 191 F | 05-838043  |

**HORNÝ PROFIL PRE PRAH WESER 86(96)/32-TI**

| Typ | Obj. číslo |
|-----|------------|
| D 8 | 05-900597  |

**DOLNÝ PROFIL PRE PRAHY  
WESER 86(96)/32-TI, WESER 75-TI**



| Typ      | Obj. číslo |
|----------|------------|
| P 47-50K | 05-557494  |

**DOLNÝ PROFIL PRE PRAH WESER 66**



| Typ    | Obj. číslo |
|--------|------------|
| P 3940 | 05-043676  |

**KONCOVKA PRAHU WESER 75-TI**



| Typ            | Obj. číslo |
|----------------|------------|
| SH-Weser ľavá  | 05-200001  |
| SH-Weser pravá | 05-210001  |

**KONCOVKA PRAHU WESER 86(96)/32-TI**



| Typ   | Obj. číslo |
|-------|------------|
| SH 50 | 05-902997  |

**VÝPLŇOVÝ PROFIL PRAHU WESER 86(96)/32-TI**



| Typ     | Obj. číslo |
|---------|------------|
| TD 20/9 | 05-886570  |

**TESNENIE PRAHU WESER 86(96)/32-TI**



| Typ       | Miera dotesnenia | Obj. číslo |
|-----------|------------------|------------|
| HA 3060   | 4 mm             | 05-755159  |
| HA 3062/2 | 2 - 3 mm         | 05-918271  |
| D 190 F   | 1 mm             | 05-118626  |

**TESNENIE PRAHU WESER 66**



| Typ   | Obj. číslo |
|-------|------------|
| TD 18 | 05-118541  |

**TESNENIE PRAHU WESER**



| Typ     | Obj. číslo |
|---------|------------|
| TD 12/1 | 05-832171  |
| TD 12/2 | 05-832195  |
| TD 12/3 | 05-832218  |
| TD 12/4 | 05-832232  |
| TD 12/5 | 05-832256  |

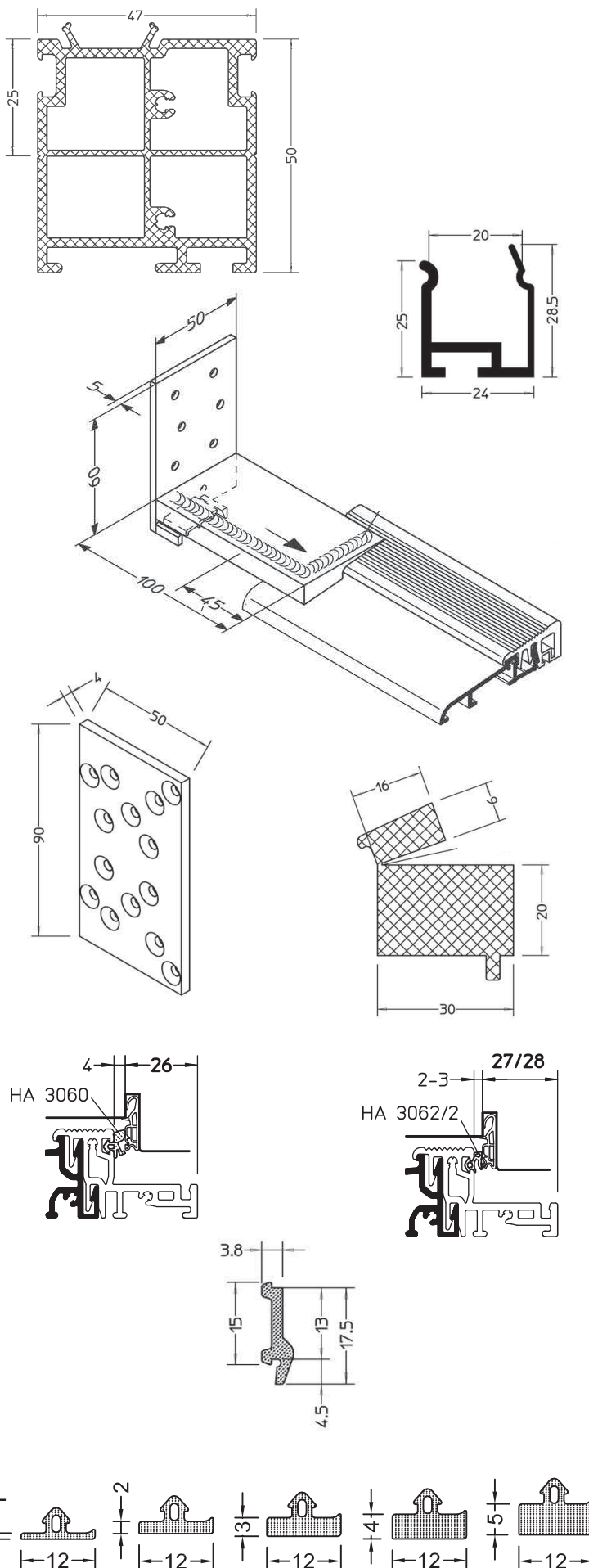

## 8.5 SYSTÉMY ZIMNÝCH ZÁHRAD

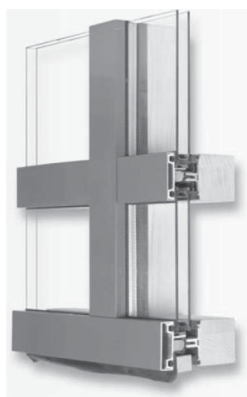

LARA

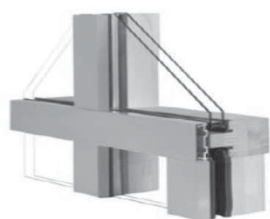
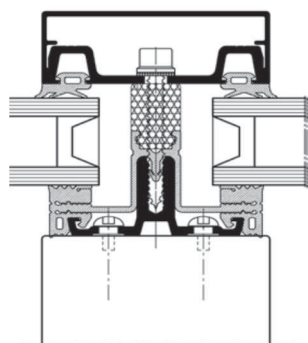

LARA Clasik

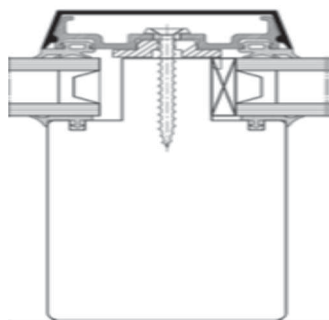

Zimná záhrada ako významný architektonický prvok musí spĺňať tie najprísnejšie kritériá čo sa týka konštrukcie a aj použitých materiálov. Systém **LARA** a **LARA Clasik** ponúka širokú škálu použitia a rokmi overenú kvalitu komplexného riešenia. Odporúčame všetkým výrobcom a projektantom, aby sa riadili postupmi a riešeniami fy. **GUTMANN**. Konkrétne riešenie vám radi pomôžu zrealizovať technickí poradcovia fy. Trendwood-twd.

## 8.6 SYSTÉMY OPLÁŠTENIA OKIEN A VCHODOVÝCH DVERÍ



MIRA

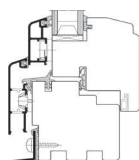

BRAGA

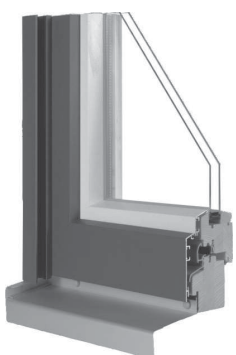
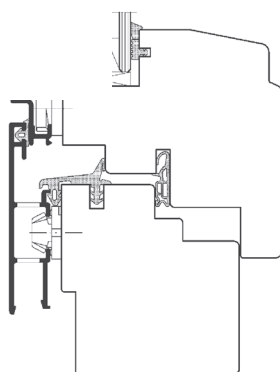

CORA

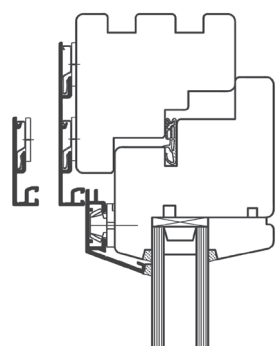

## 9.1 TESNENIE

### Q-LON

Vysoko kvalitné okenné a dverov tesnenie bez zvárania rohov s výbornými tepelno a zvukovo izolačnými vlastnosťami. Pri zmenách teploty nemení svoje fyzikálne vlastnosti. Povrchová vrstva sa znáša s vodou riediteľnými uni lakmi.



#### TESNENIE OKENNÉ STREDOVÉ QL 3053

| Farba                 | Návin     | Obj. číslo  |
|-----------------------|-----------|-------------|
| Biela                 | 2 x 200 m | 89-30531400 |
| Gaštan                | 2 x 200 m | 89-30538400 |
| Hnedá tmavá           | 2 x 200 m | 89-30530400 |
| Dub svetlý            | 2 x 200 m | 89-30535400 |
| Lieska (svetlo hnedá) | 2 x 200 m | 89-30531240 |
| Čierna                | 2 x 200 m | 89-30532400 |
| Sivá                  | 2 x 200 m | 89-30533400 |

#### TESNENIE OKENNÉ STREDOVÉ QL 3104

| Farba       | Návin     | Obj. číslo  |
|-------------|-----------|-------------|
| Biela       | 2 x 150 m | 89-30531800 |
| Gaštan      | 2 x 150 m | 89-30538800 |
| Hnedá tmavá | 2 x 150 m | 89-30530800 |
| Dub svetlý  | 2 x 150 m | 89-30535800 |

#### TESNENIE OKENNÉ DORAZOVÉ QL 3070

| Farba                 | Návin     | Obj. číslo  |
|-----------------------|-----------|-------------|
| Biela                 | 2 x 400 m | 89-30701800 |
| Gaštan                | 2 x 400 m | 89-30708800 |
| Hnedá tmavá           | 2 x 400 m | 89-30700800 |
| Dub svetlý            | 2 x 400 m | 89-30705800 |
| Lieska (svetlo hnedá) | 2 x 400 m | 89-30701280 |
| Čierna                | 2 x 400 m | 89-30702800 |
| Sivá                  | 2 x 400 m | 89-30703800 |

#### TESNENIE OKENNÉ DORAZOVÉ QL 3054

| Farba       | Návin     | Obj. číslo  |
|-------------|-----------|-------------|
| Biela       | 2 x 250 m | 89-30541500 |
| Gaštan      | 2 x 250 m | 89-30548500 |
| Hnedá tmavá | 2 x 250 m | 89-30540500 |
| Dub svetlý  | 2 x 250 m | 89-30545500 |
| Čierna      | 2 x 250 m | 89-30542500 |

#### TESNENIE NA VCHODOVÉ DVERE DORAZOVÉ QL 3097

| Farba       | Návin     | Obj. číslo  |
|-------------|-----------|-------------|
| Biela       | 2 x 150 m | 89-30971300 |
| Gaštan      | 2 x 150 m | 89-30978300 |
| Hnedá tmavá | 2 x 150 m | 89-30970300 |
| Dub svetlý  | 2 x 150 m | 89-30975300 |
| Čierna      | 2 x 150 m | 89-30972300 |
| Sivá        | 2 x 150 m | 89-30973300 |

#### TESNENIE NA VCHODOVÉ DVERE STREDOVÉ QL 3109

| Farba       | Návin     | Obj. číslo  |
|-------------|-----------|-------------|
| Biela       | 2 x 100 m | 89-31091200 |
| Gaštan      | 2 x 100 m | 89-31098200 |
| Hnedá tmavá | 2 x 100 m | 89-31090200 |
| Dub svetlý  | 2 x 100 m | 89-31095200 |
| Sivá        | 2 x 100 m | 89-31093200 |

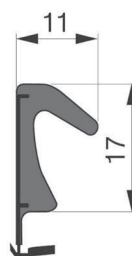
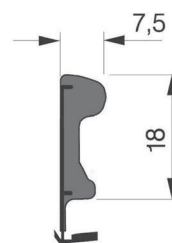
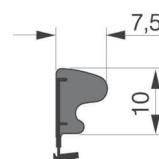
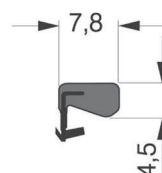
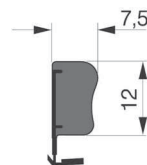
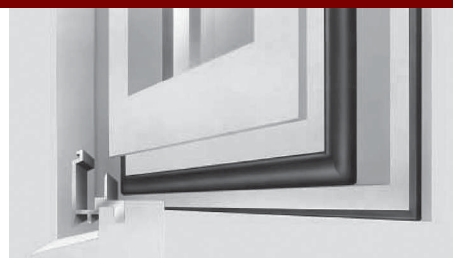

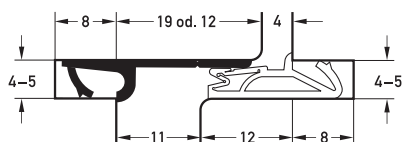
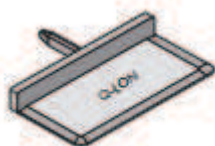
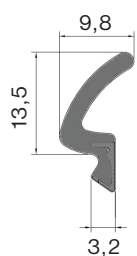
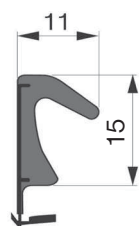
**TESNENIE NA VCHODOVÉ DVERE STREDOVÉ QL 3091**

| Farba       | Návin     | Obj. číslo  |
|-------------|-----------|-------------|
| Biela       | 2 x 150 m | 89-30911200 |
| Gaštan      | 2 x 150 m | 89-30918200 |
| Hnedá tmavá | 2 x 150 m | 89-30910200 |
| Dub svetlý  | 2 x 150 m | 89-30915200 |

**TESNENIE NA HS PORTÁL QL 7000**

| Farba  | Návin     | Obj. číslo  |
|--------|-----------|-------------|
| Sivá   | 2 x 175 m | 89-70003350 |
| Čierna | 2 x 175 m | 89-70002350 |

**KONCOVKA ŠTULPOVÉHO TESNENIA**

| Farba       | Balenie | Obj. číslo  |
|-------------|---------|-------------|
| Biela       | 100 ks  | 89-91851100 |
| Čierna      | 100 ks  | 89-91852100 |
| Hnedá tmavá | 100 ks  | 89-91850100 |
| Dub svetlý  | 100 ks  | 89-91855100 |

**ŠTULPOVÉ TESNENIE DX-1362**

| Farba       | Balenie | Obj. číslo  |
|-------------|---------|-------------|
| Biela       | 25 m    | 89-31621025 |
| Čierna      | 25 m    | 89-31622025 |
| Hnedá tmavá | 25 m    | 89-31620025 |
| Dub svetlý  | 25 m    | 89-31625025 |

**NOŽNICE**

|                    | Obj. číslo  |
|--------------------|-------------|
| Nožnice            | 89-00000001 |
| Náhradné koliečko  | 89-00000003 |
| Náhradné nože      | 89-00000002 |
| Náhradná platnička | 89-00000004 |



**TESNENIE INTERIÉROVÉ DVEROVÉ QL 3110**

| Farba       | Návin     | Obj. číslo  |
|-------------|-----------|-------------|
| Biela       | 2 x 150 m | 89-31001300 |
| Gaštan      | 2 x 150 m | 89-31008300 |
| Hnedá tmavá | 2 x 150 m | 89-31000300 |
| Dub svetlý  | 2 x 150 m | 89-31005300 |
| Sivá        | 2 x 150 m | 89-31003300 |

**TESNENIE NÁBYTKOVÉ (NA HS PORTAL) QL 3078**

| Farba  | Návin     | Obj. číslo  |
|--------|-----------|-------------|
| Čierna | 2 x 300 m | 89-30782600 |
| Sivá   | 2 x 300 m | 89-30783600 |

**ZAMENITELNOSŤ TESNENÍ**

DEVENTER S 3967 – SCHLEGEL QL 3110

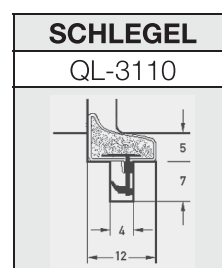
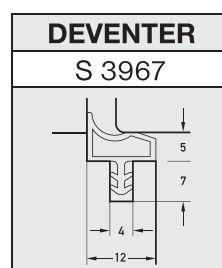
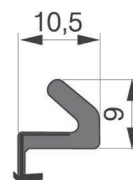
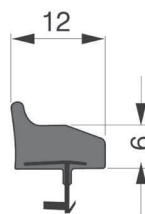

**ZAMENITELNOSŤ TESNENÍ**

DEVENTER SV 12 – DEVENTER SP 125 – SCHLEGEL QL 3053

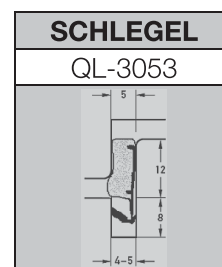
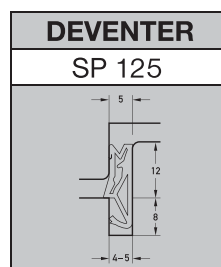
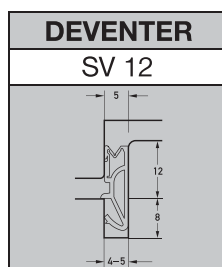

**ZAMENITELNOSŤ TESNENÍ**

DEVENTER SP 33 – DEVENTER SV 33 – SCHLEGEL QL 3070

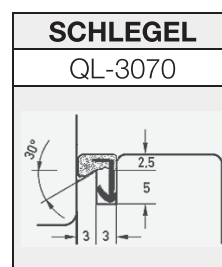
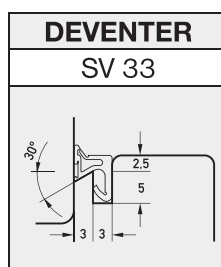
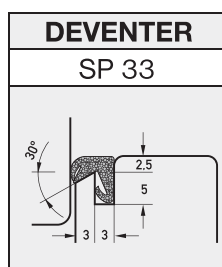

**ZAMENITELNOSŤ TESNENÍ**

DEVENTER SV 418 – SCHLEGEL QL 3097

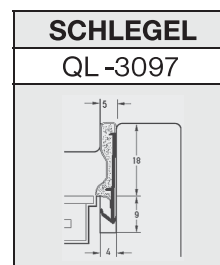
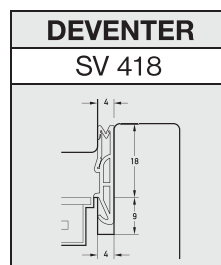

## 10.1 STAVEBNÁ CHÉMIA



### NEUTRÁLNY SILIKÓN (NO) - OXIM

na drevené rámové systémy s povrchovou úpravou syntetickými a polyuretánovými lakmi

| Obal    | Objem  | Farba       | Obj. číslo |
|---------|--------|-------------|------------|
| Kartuša | 310 ml | Transparent | 86-0240    |
| Kartuša | 310 ml | Biely       | 86-0241    |
| Kartuša | 310 ml | Hnedý       | 86-0007    |
| Kartuša | 310 ml | Šedý        | 86-0245    |
| Kartuša | 310 ml | Čierny      | 86-0242    |



### NEUTRÁLNY SILIKÓN N - ALKOXY

na drevené rámové systémy s povrchovou úpravou lazúrovacími lakmi

| Obal   | Objem  | Farba       | Obj. číslo |
|--------|--------|-------------|------------|
| Saláma | 600 ml | Transparent | 86-0165    |
| Saláma | 600 ml | Biely       | 86-3063    |
| Saláma | 600 ml | Ľovo hnedý  | 86-8004    |
| Saláma | 600 ml | Orech       | 86-8011    |



### SILIKÓNY SILVER LINE

na nesavé systémy

| Typ         | Obal    | Objem  | Farba       | Obj. číslo |
|-------------|---------|--------|-------------|------------|
| Neutrálny   | Kartuša | 310 ml | Transparent | 86-3601    |
| Neutrálny   | Kartuša | 310 ml | Biely       | 86-3602    |
| Sanitárny   | Kartuša | 310 ml | Transparent | 86-3211    |
| Sanitárny   | Kartuša | 310 ml | Biely       | 86-3212    |
| Univerzálny | Kartuša | 310 ml | Transparent | 86-3220    |
| Univerzálny | Kartuša | 310 ml | Biely       | 86-3221    |



### AKRYLOVÝ TMEL

na tmelenie špár v stavebníctve

| Obal     | Objem  | Farba | Obj. číslo |
|----------|--------|-------|------------|
| Vedierko | 1,5 kg | Biely | 86-1063    |
| Saláma   | 600 ml | Biely | 86-1062    |
| Kartuša  | 310 ml | Biely | 86-0062    |
| Kartuša  | 310 ml | Šedý  | 86-0065    |
| Kartuša  | 310 ml | Hnedý | 86-0064    |



### AKRYLOVÝ TMEL EXTERIÉROVÝ

| Obal    | Objem  | Farba | Obj. číslo |
|---------|--------|-------|------------|
| Kartuša | 310 ml | Biely | 86-0657    |

**MAXI PIŠTOĽOVÁ PUR PENA 66 LITROV**  
na maximálne efektívnu prácu pri montážach okien a dverí



| Typ   | Obal           | Objem  | Tepl. rozsah | Obj. číslo |
|-------|----------------|--------|--------------|------------|
| Letná | Pišťolová dóza | 825 ml | +5/+35 °C    | 86-4022    |
| Zimná | Pišťolová dóza | 825 ml | -15/+25 °C   | 86-4023    |

**NÍZKOEXPANZNÁ A PROFI MONTÁŽNA PUR PENA**  
na presnú a úspornú aplikáciu a na špeciálne montáže, kde je nutná minimálna expanzia a vyššia hustota



| Typ           | Obal           | Objem  | Tepl. rozsah | Obj. číslo |
|---------------|----------------|--------|--------------|------------|
| Profi         | Pišťolová dóza | 750 ml | +5/+35 °C    | 86-0320    |
| Nízkoexpanzná | Pišťolová dóza | 750 ml | +5/+35 °C    | 86-0452    |

**TRUBIČKOVÁ HOBY PUR PENA**  
na domáce použitie



| Typ     | Obal            | Objem  | Tepl. rozsah | Obj. číslo |
|---------|-----------------|--------|--------------|------------|
| Malá    | Trubičková dóza | 300 ml | +5/+35 °C    | 86-0302    |
| Stredná | Trubičková dóza | 500 ml | +5/+35 °C    | 86-0500    |
| Veľká   | Trubičková dóza | 750 ml | +5/+35 °C    | 86-0280    |

**OHŇOVZDORNÁ PUR PENA**  
na protipožiarne systémy, norma horľavosti DIN 4102 B1



| Obal            | Objem  | Tepl. rozsah | Obj. číslo |
|-----------------|--------|--------------|------------|
| Trubičková dóza | 700 ml | +5/+35 °C    | 86-0302    |

**PROFI APLIKAČNÉ PIŠTOLE NA PUR PENY**  
na aplikáciu PUR peny z pištoľových dóz



| Typ            | Použitie | Farba  | Obj. číslo |
|----------------|----------|--------|------------|
| Profi NBS-9059 | Profi    | Čierna | 86-9059    |
| Super NBS-9070 | Profi    | Zelená | 86-0520    |
| GOLD           | Profi    | Zlatá  | 86-0698    |



**TESNIACI A IZOLAČNÝ SYSTÉM DEN BRAVEN 3D** TOP KVALITA  
tesniace okenné pásky s butylom a kompresné / expanzné pásky

| Typ         | Šírka    | Farba  | Obj. číslo |
|-------------|----------|--------|------------|
| Interiérová | 75 mm    | Ružová | 86-7918    |
| Interiérová | 100 mm   | Ružová | 86-7919    |
| Exteriérová | 75 mm    | Biela  | 86-7911    |
| Exteriérová | 100 mm   | Biela  | 86-7912    |
| Kompresná   | 20/10 mm | Čierna | 86-8658    |

**DISPERZNÉ LEPIDLÁ RAKOLL** TOP KVALITA  
na lepenie všetkého druhu v drevárskom priemysle

| Typ                | Odosnosť | Balenie                       |
|--------------------|----------|-------------------------------|
| E-WB 0201          | D2       | 30 kg                         |
| Express 25, 50, PK | D2       | 1 kg, 5 kg, 30 kg             |
| Weissleim          | D2       | 280 g                         |
| E-WB 0301          | D3       | 30 kg, 150 kg                 |
| Express D3         | D3       | 30 kg, 120 kg, 250 kg, 500 kg |
| GXL 3              | D3       | 0,5 kg, 1 kg, 5 kg, 30 kg     |
| Duplit AL, AS      | D4       | 5 kg, 30 kg                   |
| GXL 4              | D4       | 5 kg, 30 kg                   |

**DISPERZNÉ LEPIDLÁ JOWACOLL** TOP KVALITA  
na lepenie všetkého druhu v drevárskom priemysle

| Typ    | Odosnosť | Balenie                           |
|--------|----------|-----------------------------------|
| 102.49 | D2       | 3 kg, 5 kg, 25 kg                 |
| 104.05 | D2       | 0,15 kg, 0,5 kg, 1 kg, 3 kg, 5 kg |
| 113.10 | D2       | 0,15 kg, 0,5 kg, 1 kg, 3 kg, 5 kg |
| 103.10 | D3       | 0,15 kg, 0,5 kg, 1 kg, 3 kg, 5 kg |
| 107.00 | D4       | 0,15 kg, 0,5 kg, 1 kg, 3 kg, 5 kg |
| 685.12 | PUR      | 1 kg                              |

**OPRavnÉ VOSKOVÉ TYČINKY KÖNIG** TOP KVALITA  
na opravovanie dierok, trhlín drážok, atď. v dreve a plaste  
Prevedenie:

- tvrdé (nutnosť použiť tavnú pištoľ)
- mäkké

**VODOU RIEDITEĽNÝ TMEL NA DREVO CLOU HOLZPASTE** TOP KVALITA  
na vytmelenie dierok, medzier, trhlín a priehlbín v dreve alebo dýhe. Veľmi ľahko sa s ním pracuje, rýchlo schne, vyplňuje veľmi dobre bez prasklín a neprepadáva sa.

| Farba       | Obj. číslo | Farba             | Obj. číslo |
|-------------|------------|-------------------|------------|
| 1, prírodný | 18-2501    | 25, jelša         | 18-2525    |
| 2, smrek    | 18-2501    | 26, červený smrek | 18-2526    |
| 3, borovica | 18-2503    | 4, buk            | 18-2504    |
| 5, dub      | 18-2505    | 8, dub stredný    | 18-2508    |
| 10, orech   | 18-2510    | orech tmavý       | 18-2513    |
| 13, mahagón | 18-2513    | 12, mahagón tmavý | 18-2512    |
| 9, čerešňa  | 18-2509    | 24, čerešňa tmavá | 18-2524    |
| 16, biely   | 18-2516    | 17, čierny        | 18-2517    |

## 11.1 TERASOVÉ PODLAHY

### TERASOVÉ PODLAHY WOODPLASTIC



WOODPLASTIC je zložením materiál z dreva a plastových komponentov, ktorý svojím prirodzeným vzhľadom a pocitom pripomína drevo. Vďaka použitej kompozícii materiálov je WOODPLASTIC prirodzene odolný voči vode, slnku, mrazu, hmyzu a v žiadnom prípade nedochádza k poškodzovaniu chlórrom ani morskou vodou. Je to farebne stály materiál odolný voči UV žiareniu. WOODPLASTIC je plnohodnotný konkurent dreva.

Príklady použitia materiálov WOODPLASTIC:

- Terasy
- Pergoly
- Podlahy okolo bazénov
- Obklad bazénov
- Fasádny obklad
- Záhradný nábytok

| Vlastnosť                                    | WOOD PLASTIC | Drevo | Plast |
|--|--------------|-------|-------|
| Stála farebnosť                              | qq           |       |       |
| Ochrana proti hnilobe                        | qq           |       | qq    |
| Minimálna údržba                             | qq           |       | qq    |
| Nerozštepí sa a nebledne                     | qq           |       | q     |
| Nemenný, odolný prírodný vzhľad              | qq           | q     |       |
| Odolný dokonca aj bez škodlivého ošetrovania | qq           |       | q     |
| Protišmykový                                 | qq           | q     |       |
| Lahko spracovateľný a montovateľný           | qq           | qq    | q     |
| Odolný voči hmyzu a drevokazným hubám        | qq           |       | qq    |

| Produkt              | Rozmery     | Štandardná dĺžka/balenie | Povrchová úprava                                   |
|----------------------|-------------|--------------------------|--|
| Terasové dosky SILVA | 140 x 23 mm | 4 m balené po 104 ks     | Šedozelená, Hnedá, Svetlohnedá, Tmavohnedá         |
| Hrana                | 70 x 20 mm  | 2 m balené po 100 ks     | Šedozelená, Čierna, Hnedá, Svetlohnedá, Tmavohnedá |
| Roh                  | 33 x 33 mm  | 2 m balené po 100 ks     | Šedozelená, Svetlohnedá, Tmavohnedá                |
| Nosič                | 50 x 50 mm  | 3 – 4 m balené po 108 ks | Prírodná   |
| Klip + vrut          |             | 30 ks/bal                | Antikorová oceľ                                    |
| Klip dvojité + vrut  |             | 10 ks/bal                | Antikorová oceľ                                    |
| Start klip + vrut    |             | 10 ks/bal                | Antikorová oceľ                                    |

Terasové dosky SILVA – vlastnosti:

- Rozmery – 140 x 23 x 4000 mm
- Váha – 3,35 kg/bm
- Nosnosť – 450 kg/m<sup>2</sup>
- Záruka na drevokazné huby a hmyz – 25 rokov
- Množstvo na m<sup>2</sup>: terasové dosky – 7 ks  
nosič – 3 ks  
klipy – 19 ks

Viac informácií nájdete na [www.twd.sk](http://www.twd.sk) a [www.woodplastic.sk](http://www.woodplastic.sk)

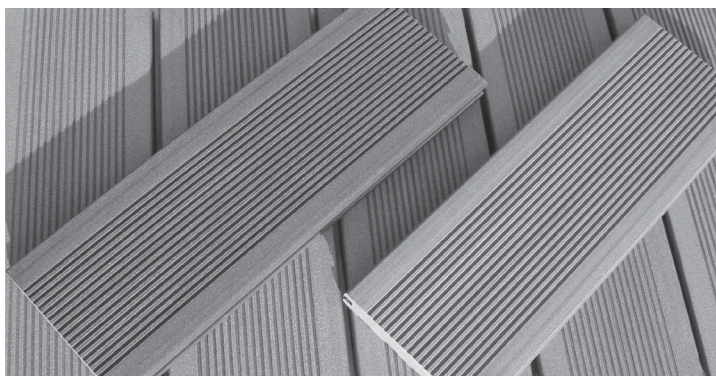

## 11.2 AKUSTICKÉ OBKLADY

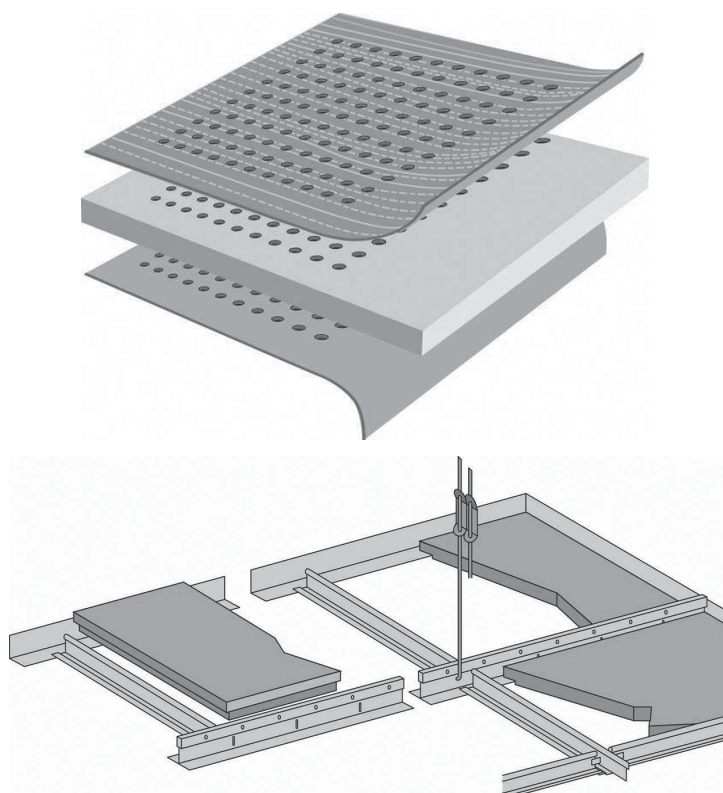

STROPNÁ INŠTALÁCIA

minimálna hrúbka panelov: 18 mm, maximálne rozmery: 1200 x 600 mm

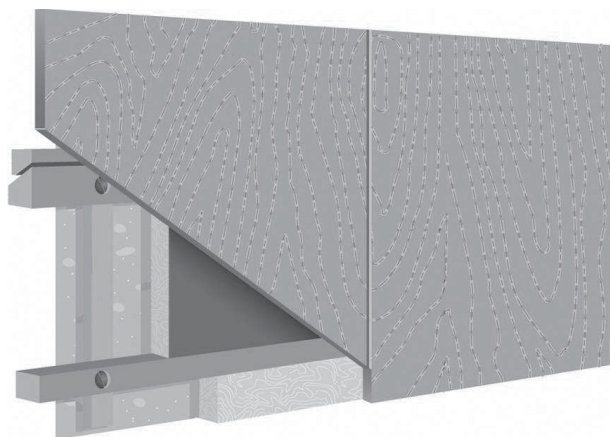

INŠTALÁCIA NA STENU S DREVENÝM ROŠTOM



### AKUSTICKÉ OBKLADY OBER SOUND

OBERSOUND sú na objednávku vyrobené pravé drevené panely. Základom panelov je laminát OBERFLEX z pravého dreva, ktorý je dostupný vo všetkých odtieňoch z kolekcií Oberflex / Prestige d'Oberflex, Les Sablés s povrchom Mat a Spiced Wood. Keďže ide o produkt vyrobený na objednávku, je úplne na vás, aký druh dreva, perforáciu alebo rozmery zvolíte. Kazety OBER SOUND sú obzvlášť vhodné na inštaláciu v divadlách, konferenčných sálach, posluchárňach, kinách, hoteloch či reštauráciách. Možnosti využitia sú široké.

Ide o finálny produkt, je teda možné ho okamžite inštalovať, nevyžaduje žiadne ďalšie úpravy. OBER SOUND sa skladá z podkladu, ku ktorému je z jednej strany nalisovaný laminát z pravého dreva OBERFLEX. Z druhej strany je podklad vyvážený. Perforované panely OBER SOUND zlepšujú akustiku miestnosti, v ktorej sú nainštalované.

Vlastnosti akustických obkladov OBER SOUND:

- Typy povrchov – Satén, Reliéf, Mat, Surové drevo
- Podklad – DTD (štandardná, vodeodolná alebo žiaruvzdorná), MDF (štandardná alebo žiaruvzdorná), iné – konzultujte s nami
- Hrúbka podkladu – DTD: 10 mm, 12 mm, 16 mm, 19 mm, 22 mm, MDF: 16 mm
- Rozmery – dosky s hranami bez povrchovej úpravy DTD: 304 x 123 cm • 250 x 123 cm, MDF: 304 x 120 cm • 250 x 120 cm dosky s frézovanými hranami DTD: 303 x 122 cm • 249 x 122cm, MDF: 303 x 119 cm • 249 x 119 cm neštandardné prevedenie: akékoľvek rozmery nepresahujúce 303 x 120 cm (drevotriesková doska) alebo 303 x 119 cm (MDF) stropná inštalácia 120 x 60 cm • 60 x 60 cm ... iné konzultujte s nami
- Perforácia – kruhová, oválna, iné – konzultujte s nami
- Odolnosť voči ohňu – M2 (SNPE 9153-00) – štandardná DTD, nadštandardné prevedenie M1 (SME 11639-04) – žiaruvzdorná DTD, M1 (SNPE 9152-00) – žiaruvzdorná MDF. Index šírenia plameňa po povrchu stavebných hmôt podľa ČSN 73 0863:1992  $i_s = 34,9$  mm/min
- Veľmi vysoká odolnosť voči UV žiareniu
- Odolnosť voči oteru – pri paneloch s nadštandardnou odolnosťou viac než 4000 otáčok.

## 11.3 KOMPAKTNÉ OBKLADOVÉ DOSKY



### KOMPAKTNÉ OBKLADOVÉ DOSKY FUNDERMAX

MAX EXTERIOR a INTERIOR je vysokokvalitný konštrukčný produkt, ktorého použitie je špeciálne určené na balkóny, interiéry a fasádne obklady. MAX EXTERIOR a INTERIOR dosky sú tvrdené HPL lamináty, ktoré spĺňajú normu EN 438 typu EDF s extrémne dobrou ochranou proti poveternostným vplyvom. Táto ochrana je docielená dvojším tvrdením akrylátovo-polyuretánovej živice, ktorá sa pridáva pri lisovaní pod veľkým tlakom a pri vysokej teplote. Pre MAX EXTERIOR a INTERIOR dosky je samozrejme CE známka, ktorá je nevyhnutná pre použitie v stavebníctve. MAX EXTERIOR a INTERIOR dosky je možné ľubovoľne formátovať podľa požiadaviek.

#### Vlastnosti:

- Vysoká odolnosť voči poveternostným vplyvom
- Farebná stálosť
- Dvakrát tvrdené
- Oderuzdorný povrch
- Odolnosť voči rozpúšťadlám
- Nenáročné na čistenie
- Povrch odolný voči poškodeniu
- Použiteľný v exteriéri
- Dekoratívny, okrasný
- Vyznačuje sa pevnosťou a tvarostálosťou
- Odolné voči ohybu
- Mrazuvzdorný
- Odolný voči teplu
- Neobsahuje ťažké kovy
- Jednoduchá montáž

Hrúbky: 4, 6, 8, 10, 12, 14, 16, 18, 20 mm



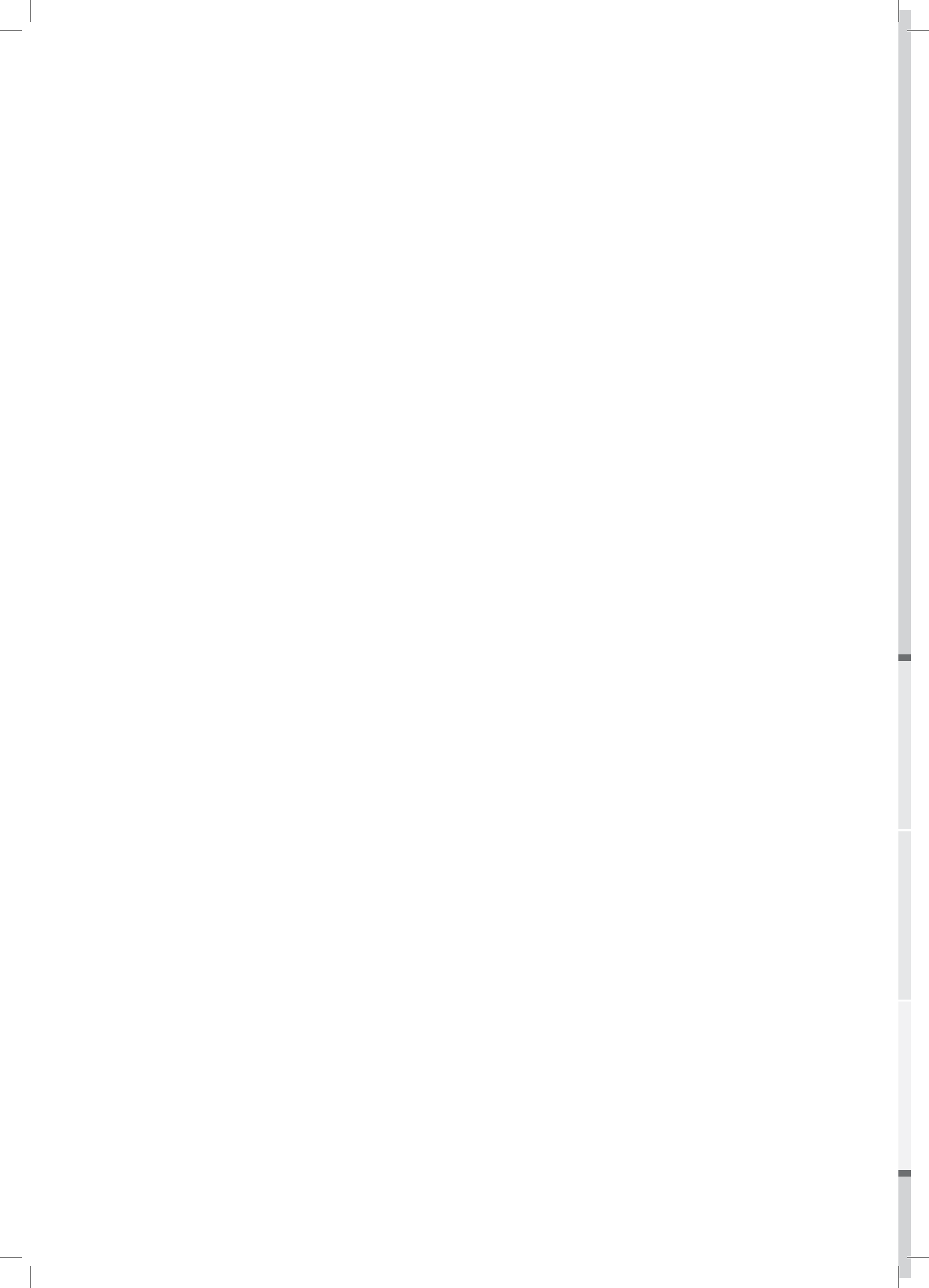



# ELEKTRO- NÁRADIE



**Elektrocentrála rámová benzínová  
EGM 25 AVR**

|  |
|--|
| výkon max./menovitý 2,3 kW/2,0 kW  |
| napätie/frekvencia 230V/50 Hz  |
| počet fáz 1  |
| účinník 1  |
| typ motora: benzínový, štvortaktný jednovalec<br>s OHV rozvodom, obsah 163ccm, štartovanie ručné |
| max. výkon motora 4,0 kW (5,5HP)/4000 min  |
| spotreba ≤ 0,5l/kWh (pri 75% zaťažení)   |
| DC menovitý prúd 8,3A/ 12V   |
| objem nádrže 15 l  |
| rozmery (výška x šírka x dĺžka) 45 x 44 x 59 cm  |
| hmotnosť 43 kg   |

obj.č. 47-8896111

**Elektrocentrála rámová benzínová  
EGM 60 AVR-3**

|  |
|--|
| výkon max./menovitý 6,0kW/5,0kW (400V/50Hz)  |
| výkon max./menovitý 2,2kW/2,0kW (230V/50Hz)  |
| počet fáz 3  |
| účinník 3 fáz./1fáz. = 0,8/1   |
| typ motora: benzínový, štvortaktný jednovalec<br>s OHV rozvodom, obsah 389ccm, štartovanie ručné |
| max. výkon motora 9,0 kW (13HP)/4000min  |
| spotreba ≤ 0,45l/kWh (pri 75% zaťažení)  |
| DC menovitý prúd 8,3A/ 12V ~ objem nádrže 25l  |
| rozmery (výška x šírka x dĺžka) 57x52x69cm   |
| hmotnosť 87 kg   |

obj.č. 47-8896112

**Vrtačka príklepová dvojrychlostná  
HDS 1100 MA**

|  |
|--|
| príkon 1100W                             |
| pravý/ľavý chod                          |
| voľnobežné otáčky: I. 0-1100 min         |
| II. 0-3000 min                           |
| počet úderov: I. 0-10000 min             |
| II. 0-28000 min                          |
| max. priemer vrtu do muríva 13mm         |
| max. priemer vrtu do ocele/dreva 13/25mm |
| upínací rozsah skľučovadla 1,5-13mm      |
| hmotnosť 2,75kg                          |

obj.č. 47-889005

#### Brúska uhlová AG 150 EP

|                             |
|-----------------------------|
| príkon 1300W                |
| priemer 150mm               |
| voľnobežné otáčky 7800min   |
| vreťeno M14                 |
| dĺžka prívodného kábla 2,5m |
| hmotnosť 3,3kg              |

obj.č. 47-8892005

#### Frézka horná RT 1200 EH

|   |
|---|
| príkon 1200W                                  |
| elektronická regulácia otáčok 10000-28000 min |
| frézovanie kružníc do pr. 255mm               |
| upínacie klieštiny 6mm / 8mm                  |
| hmotnosť 3,5kg                                |

obj.č. 47-8893302

#### Hoblík falcovací EP 900 F

|   |
|---|
| príkon 900W   |
| hoblňovacia šírka 82mm  |
| voľnobežné otáčky 16000 min                                   |
| plynule nastaviteľné uberanie 0-3mm,<br>odstupňované po 0,1mm |
| hĺbka polodrážky 0-15mm                                       |
| dĺžka základne 305mm  |
| hmotnosť 2,8kg  |

obj.č. 47-8893401

#### Brúska excentrická ERS 450 SCP

|  |
|--|
| príkon 450W                              |
| počet kmitov vo voľnobehu 4000-13000 min |
| priemer unášacieho taniera 150mm / 125mm |
| priemer brúsneho papiera 150mm / 125mm   |
| priemer kmitu 5mm                        |
| hmotnosť 2,6kg                           |

obj.č. 47-8894202

#### Brúska pásová EBS 900 VS

|                                      |
|--------------------------------------|
| príkon 900W                          |
| brúsny pás 533x76 mm                 |
| regulácia rýchlosti pásu             |
| rýchlosť pásu naprázdno 150-360m/min |
| hmotnosť 3,6kg                       |

obj.č. 47-8894305



**Zváračka plastových rúr polyfúzna PTW 90**

|   |
|---|
| príkonnosť 800 W                          |
| regulácia teploty matrice 220 °C - 260 °C |
| doba náběhu teploty <15 minút             |
| hmotnosť 1,0 kg                           |

obj.č. 47-8897210

**Pišťoľ teplovzdušná HG 18 VT**

|  |
|--|
| príkonnosť 1800 W  |
| pracovná teplota/prietok vzduchu:<br>I. stupeň: 75-400 °C / 250 l/min<br>II. stupeň: 85-600 °C / 550 l/min |
| nastavenie teploty plynu po 1°C  |
| hmotnosť 0,7 kg  |

obj.č. 47-8894802

**Zváračka plastových rúr polyfúzna**

|                              |
|------------------------------|
| príkonnosť 750W/1500W        |
| 2 špirály                    |
| nastavenie teploty 0-300°C   |
| doba náběhu teploty <10minút |
| hmotnosť 3,0 kg              |

obj.č. 47-419310

**Skľučovadlo rýchloúkladné**

|                    |
|--------------------|
| 1-13mm, 1/2"-20UNF |
|--------------------|

obj.č. 47-079992

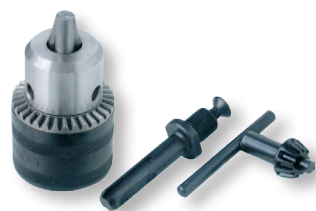
**Skľučovadlo s redukciou SDS-plus a kľúčom**

|                               |
|-------------------------------|
| 3-dielna sada, 1,5-13mm-20UNF |
|-------------------------------|

obj.č. 47-079998

#### Stojan na vrtačku

pr.35/43mm, výška 430mm, zvislý

obj.č. 47-080369

#### Stojan na uhlovú brúsku

pre brúsky 115/125mm

hĺbka rezu 40/35mm

rozovretie zveráku 75mm

obj.č. 47-888810

#### Sada nástrčných a zástrčných kľúčov 60-dielna

obj.č. 47-4700011

#### Kľúče Torx zástrčné (s dierkou)

9-dielna sada

TX10-15-20-25-27-30-40-45-50

plastový držiak

obj.č. 47-006601

#### Kľúče imbusové s guľôčkou

9-dielna sada

1,5-2-2,5-3-4-5-6-10mm

plastový držiak

obj.č. 47-006609



**Skrutkovač, magnetický držiak na bity**

|                                  |
|----------------------------------|
| 19 bitov                         |
| PH1-2-3, (-) 4-5-6mm             |
| T10-15-20-25-27-30               |
| nástrčné kľúče 5-6-7-8-9-10-11mm |

obj.č. 47-8819101

**Skrutkovač hodinársky,  
magnetický držiak na bity**

|                                       |
|---------------------------------------|
| 32-dielna sada,                       |
| 115mm, T5-6-7                         |
| Tvrdý 8-9-10-15-20 (-)1-1,5-2-2,5-3-4 |
| PH000-00-0-1                          |
| PZO-1, imbus 1,3-1,5-2-2,5-3-3,5-4mm  |
| SD2,6, triwing TW3                    |
| trojuholník TA3, pinzeta              |

obj.č. 47-8819105

**Nadstavec na bity magnetický**

|              |
|--------------|
| 1/4" x 60 mm |
|--------------|

obj.č. 47-483001

**Kotúč rezný diamantový Turbo**

|                  | obj. číslo |
|------------------|------------|
| 115 mm x 22,2 mm | 47-108751  |
| 125 mm x 22,2 mm | 47-108752  |
| 150 mm x 22,2 mm | 47-108753  |
| 180 mm x 22,2 mm | 47-108754  |
| 230 mm x 22,2 mm | 47-108755  |

**Kotúč rezný diamantový  
segmentový**

|                  | obj. číslo |
|------------------|------------|
| 115 mm x 22,2 mm | 47-108711  |
| 125 mm x 22,2 mm | 47-108712  |
| 150 mm x 22,2 mm | 47-108713  |
| 180 mm x 22,2 mm | 47-108714  |
| 230 mm x 22,2 mm | 47-108715  |

#### Kotúč brúsny diamantový

|                                     |
|-------------------------------------|
| 115 mm x 22,2 mm                    |
| výška segmentov 5 mm                |
| počet segmentov 30                  |
| max. otáčky 13200 min <sup>-1</sup> |

obj.č. 47-880311

#### Kotúč brúsny diamantový

|                                     |
|-------------------------------------|
| 125 mm x 22,2 mm                    |
| výška segmentov 5 mm                |
| počet segmentov 30                  |
| max. otáčky 12000 min <sup>-1</sup> |

obj.č. 47-880312

#### Vrtáky do dreva

|                        |
|------------------------|
| 8-dielna sada          |
| pr. 3-4-5-6-7-8-9-10mm |
| plastové puzdro        |

obj.č. 47-001142

#### Vrtáky do dreva

|                       |
|-----------------------|
| 6-dielna sada         |
| pr. 6-8-10-12-13-14mm |
| dĺžka 300 mm          |

obj.č. 47-001156

#### Vrtáky do dreva ploché DIN3126

|                        |
|------------------------|
| 6-dielna sada          |
| pr.10-12-16-18-20-25mm |
| 6-hranná stopka 1/4"   |
| textilné puzdro        |

obj.č. 47-880121

#### Sukovník (Forstnerov vrták) HSS s SK plátkami

|                      |
|----------------------|
| pr. 35mm             |
| dĺžka 80 mm          |
| stopka pr. 3 x 25 mm |

obj.č. 47-045014

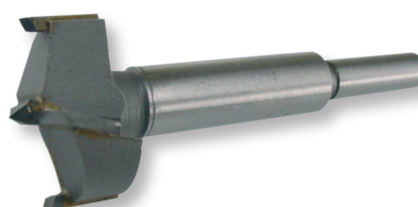
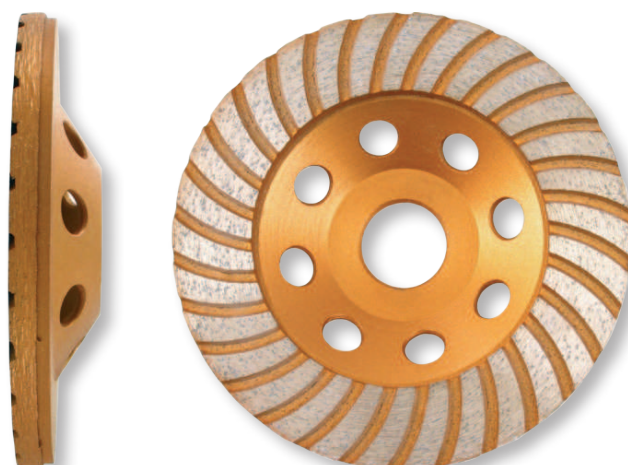

**Sukovníky (Forstnerove vrtáky) HSS**

|                     |
|---------------------|
| 5-dielna sada       |
| pr.15-20-25-30-35mm |
| dĺžka 90mm          |
| stopka pr.8x25mm    |
| drevené puzdro      |

obj.č. 47-044015

**Frézy profilové HSS s SK plátkami**

|                |
|----------------|
| 12-dielna sada |
| stopka 8mm     |
| drevené puzdro |

obj.č. 47-044032



**Frézy profilové HSS s SK plátkami**

|                  |
|------------------|
| 24-dielna sada   |
| stopka 8 mm      |
| hliníkový kufrík |

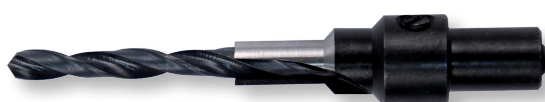
obj.č. 47-044039

**Vrták na konfirmáty HSS**

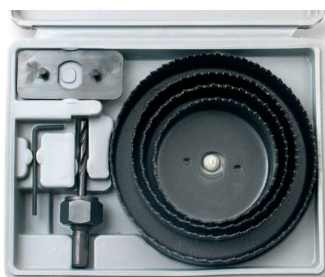
|      | obj. číslo |
|------|------------|
| 5 mm | 47-8801205 |
| 7 mm | 47-8801207 |

**Píla do dreva dierovacia**

|  | obj. číslo |
|--|------------|
| pr.54-76-89-102-127mm, hĺbka 25 mm, stopka pr.10 mm, plastové puzdro | 47-001807  |
| pr.26-32-38-45-50-56-63 mm, hĺbka 50 mm, stopka pr.6 mm              | 47-001802  |

**Píla do dreva dierovacia s kalenými zubami**

|  |           |
|--|-----------|
| pr.60-67-74-81-95 mm, hĺbka 38 mm, stopka pr.10 mm | 47-001803 |
|--|-----------|

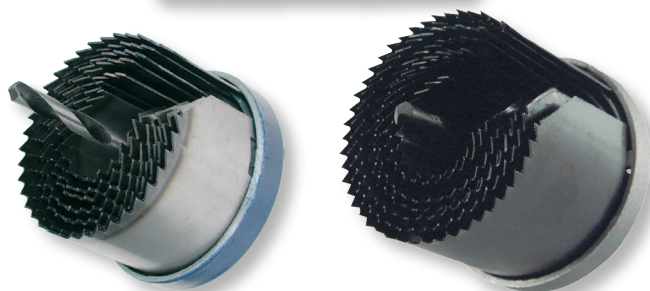



**Vrták korunkový wolfrámový**

pr.33-53-73mm

hĺbka 60mm

6-hranná stopka

obj.č. 47-019600

**Vrták korunkový s SK plátkami, SDS-plus**

pr. 73 mm

hĺbka 55 mm

obj.č. 47-026002

**Pílka na drevo**

obj. číslo

400 mm

47-8812201

450 mm

47-881222

**Pílka na konáre**

200mm

skladacia. poistka

obj.č. 47-070072

**Pílka na pórobetón**

760 mm

17 SK - plátkov

obj.č. 47-881223

**Nožnice na plech, prevodové**

obj. číslo

do 1,2mm, vyhnuté, ľavé

048060

do 1,2mm, vyhnuté, pravé

048070

obj.č. 47-048060



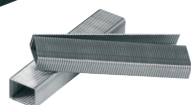

rohová

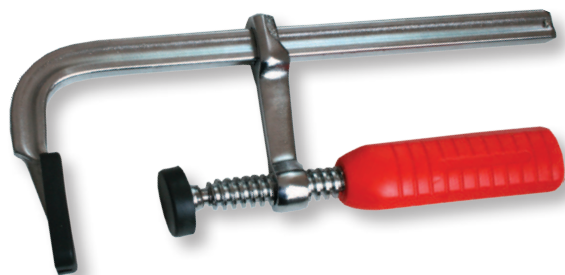
**Pišťol' sponkovacia**

dĺžka spony 4-14mm

hrúbka spony 0,7mm

nastaviteľný tlak

obj.č. 47-885110

**Tyč na rozoberanie dební  
„pajser“**

obj. číslo

600 mm

47-009810

800 mm, hr. 18mm

47-884608

**Kladivo gumené biele  
sklolaminátová pogumovaná  
násada**

obj. číslo

pr.45mm, dĺžka 100mm

47-012605

pr.55mm, dĺžka 135mm

47-012606

pr.65mm, dĺžka 150mm

47-012609

**Svorka rýchlopínacia**

obj. číslo

čefuste 65x25mm, hliníková zliatina 90°

47-881540

200 mm

47-715505

150 mm

47-881521

300 mm

47-881523

600 mm

47-881526

**Svorka stolárska  
kovaná plastová rukoväť**

obj. číslo

160x60 mm

47-8815002

200x60 mm

47-8815003

250x60 mm

47-8815004

300x60 mm

47-8815005

300x100 mm

47-8815025

600x100 mm

47-8815027

**Meradlo posuvné kovové**

0-150mm

rozdelenie 1/20

presnosť 0,05mm

plastové puzdro

obj.č. 47-003425

**Meter zvinovací**

obj. číslo

pogumovaný, 1x brzda, 3 m,  
šírka pásu 16 mm

40-3145

pogumovaný, 1x brzda, 5 m,  
šírka pásu 19 mm

40-3146

pogumovaný, 1x brzda, 7,5 m;  
šírka pásu 25 mm

40-3147

**Pásmo meracie, kovový pás**

obj. číslo

20 m, šírka pásu 10 mm

47-012200

30 m, šírka pásu 10 mm

47-012300

50 m, šírka pásu 10 mm

47-012500

**Uholník**

obj. číslo

príložný hliníkový

47-003327

príložný hliníkový nastaviteľný

47-018799

**Vodováha hliníková 2 libely**

obj. číslo

400 mm

47-103574

500 mm

47-103575

600 mm

47-103576

800 mm

47-103578

1000 mm

47-103580

1200 mm

47-103582

1500 mm

47-103585

1800 mm

47-103588

2000 mm

47-103589

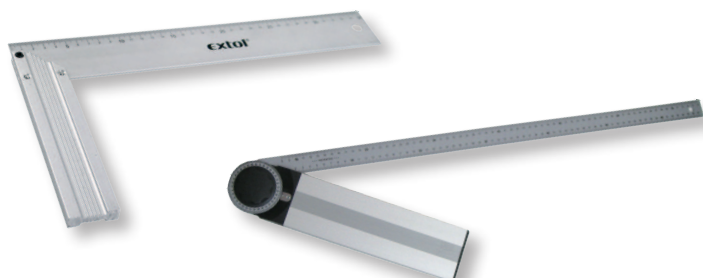
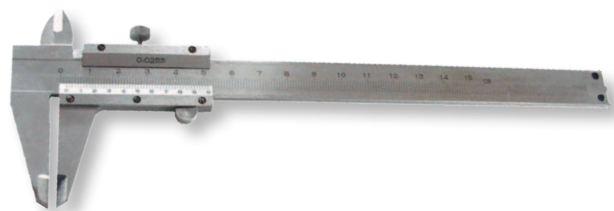

**Pišťoľ na tmel poloskeletová kovová**

225 mm, otočná

obj.č. 47-8845104

**Pišťoľ na aplikáciu polyuretánovej peny**

460g

s reguláciou prietoku

tesnosť 24hod.

ocel'-hliník-plast

obj.č. 47-085020

**Okuliare ochranné polykarbónové skladacie**

obj.č. 47-009733

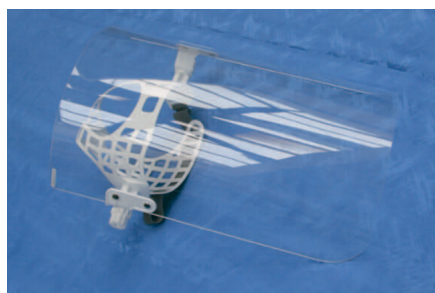
**Ochranný štít polykarbónový**

33x29 cm hr. 2mm

obj.č. 47-000290



| Plachta zakrývacia PE štandard | obj. číslo |
|--------------------------------|------------|
| 3x5 m, oká po celom obvode     | 47-011111  |
| 4x5 m, oká po celom obvode     | 47-011122  |
| 4x6 m, oká po celom obvode     | 47-011112  |
| 5x8 m, oká po celom obvode     | 47-011113  |
| 8x12 m, oká po celom obvode    | 47-011115  |
| 10x15 m, oká po celom obvode   | 47-011116  |

**Pás sťahovací na parkety**

5m, s napínaním

obj.č. 47-082355

| Pás sťahovací „gurtňa“                                   | obj. číslo |
|--|------------|
| + 2 háky, dĺžka 5 m, šírka 32 mm, max. zaťaženie 1000 kg | 47-8861125 |
| + 2 háky, dĺžka 6 m, šírka 50 mm, max. zaťaženie 3000 kg | 47-082373  |
| dĺžka 5 m, nosnosť 200 kg                                | 47-009680  |
| + 2 háky, dĺžka 5 m, nosnosť 200 kg                      | 47-009681  |

| Pásy sťahovacie čierne          | obj. číslo |
|---------------------------------|------------|
| 2,5x100 mm, 100 ks, pr.22,8 kg  | 47-8856152 |
| 2,5x150 mm, 100 ks, pr.35,8 kg  | 47-8856154 |
| 3,6x200 mm, 100 ks, pr.50,18 kg | 47-8856156 |
| 4,8x250 mm, 100 ks, pr.65,22 kg | 47-8856160 |
| 4,8x300 mm, 100 ks, pr.82,22 kg | 47-8856162 |

**Vložka cylindrická poniklovaná**

65 mm, 3x kľúč

obj.č. 47-009401





| Nôž univerzálny olamovací                                      | obj. číslo |
|--|------------|
| 18mm, zásobník na 3 brity, kovová výstuž, pogumovaný, autostop | 47-080044  |
| 18mm, hliníkový, kovová výstuž, pogumovaný, autostop           | 47-080049  |

| Nôž univerzálny zatvárací s poistkou                        |
|---|
| 150mm, celokovový,<br>spona na opasok + zásobník a 5 brítov |

obj.č. 47-885500

| Sekera sklolaminátová pogumovaná násada |
|---|
| DIN5131, GS                             |
| 1250g, 720mm                            |

obj.č. 47-8871226

| Sekera drevená násada | obj. číslo |
|-----------------------|------------|
| 600 g, 360 mm         | 47-003820  |
| 800 g, 380 mm         | 47-003821  |
| 1000 g, 440 mm        | 47-003822  |
| 1250 g, 700 mm        | 47-003826  |
| 1400 g, 700 mm        | 47-003827  |

| Káľačka sklolaminátová pogumovaná násada |
|--|
| DIN5131, GS                              |
| 3000 g                                   |

obj.č. 47-8871228

**DCD780C2**  
**Kompaktná vŕtačka / skrutkovač XR**

|                             |                        |
|-----------------------------|------------------------|
| Napájacie napätie           | 18 V                   |
| Kapacita skľučovadla        | 1,5 - 13 mm            |
| Výkon                       | 350 W                  |
| Otáčky naprázdno            | 0 - 600 / 2000 ot./min |
| Max. kútiaci moment         | 60 Nm                  |
| Max. priemer otvoru [drevo] | 38 mm                  |
| Max. priemer otvoru [kov]   | 13 mm                  |
| Hmotnosť                    | 1,55 kg                |
| Batéria                     | 1,5 Ah                 |

obj.č. 57-1780



**DCD780L2**  
**18V vŕtačka 2x aku Li-Ion**

|                             |                        |
|-----------------------------|------------------------|
| Napájacie napätie           | 18 V                   |
| Kapacita skľučovadla        | 1,5 - 13 mm            |
| Výkon                       | 350 W                  |
| Otáčky naprázdno            | 0 - 600 / 2000 ot./min |
| Max. krútiaci moment        | 60 Nm                  |
| Max. priemer otvoru [drevo] | 38 mm                  |
| Max. priemer otvoru [kov]   | 13 mm                  |
| Hmotnosť                    | 1,84 kg                |
| Batéria                     | 3,0 Ah                 |

obj.č. 57-3780



**DCD985L2**  
**18V XRP vŕtačka s príklepom,  
2 x 3,0 Ah Li-Ion, 55 Nm**

|                              |                                  |
|------------------------------|----------------------------------|
| Napájacie napätie            | 18 V                             |
| Batéria                      | 3,0 Ah                           |
| Kapacita skľučovadla         | 1,5-13 mm                        |
| Výkon                        | 500 W                            |
| Otáčky naprázdno             | 0-575/0-1350/0-2000<br>ot./min   |
| Úderov/min                   | 0-9755/0-22950/<br>0-34000 ú/min |
| Max. krútiaci moment         | 80 Nm                            |
| Max. priemer otvoru [drevo]  | 50 mm                            |
| Max. priemer otvoru [kov]    | 13 mm                            |
| Max. priemer otvoru [murivo] | 16 mm                            |
| Hmotnosť                     | 2,42 kg                          |

obj.č. 57-0985



**DCD730C2**  
**14,4V vŕtačka 2x aku Li-Ion / 1,5 Ah / 32 Nm**

|                             |                        |
|-----------------------------|------------------------|
| Napájacie napätie           | 14,4 V                 |
| Kapacita skľučovadla        | 1,5 - 13 mm            |
| Výkon                       | 300 W                  |
| Otáčky naprázdno            | 0 - 550 / 1900 ot./min |
| Max. krútiaci moment        | 57 Nm                  |
| Max. priemer otvoru [drevo] | 35 mm                  |
| Max. priemer otvoru [kov]   | 13 mm                  |
| Hmotnosť                    | 1,5 kg                 |
| Batéria                     | 1,5 Ah                 |

obj.č. 57-3730

**DCD730L2**  
**14,4V vŕtačka 2x aku Li-Ion / 3,0 Ah / 32 Nm**

|                             |                        |
|-----------------------------|------------------------|
| Napájacie napätie           | 14,4 V                 |
| Kapacita skľučovadla        | 1,5 - 13 mm            |
| Výkon                       | 300 W                  |
| Otáčky naprázdno            | 0 - 550 / 1900 ot./min |
| Max. krútiaci moment        | 57 Nm                  |
| Max. priemer otvoru [drevo] | 35 mm                  |
| Max. priemer otvoru [kov]   | 13 mm                  |
| Hmotnosť                    | 1,73 kg                |
| Batéria                     | 3,0 Ah                 |

obj.č. 57-2730

**DCF835L3**  
**14,4V BEZUHLÍKOVÝ rázový ťahovák**  
**2x aku Li-Ion / 3,0 Ah / 150 Nm**

|                             |                        |
|-----------------------------|------------------------|
| Napájacie napätie           | 14,4 V                 |
| Kapacita skľučovadla        | 1,5 - 13 mm            |
| Výkon                       | 300 W                  |
| Otáčky naprázdno            | 0 - 550 / 1900 ot./min |
| Max. krútiaci moment        | 57 Nm                  |
| Max. priemer otvoru [drevo] | 35 mm                  |
| Max. priemer otvoru [kov]   | 13 mm                  |
| Hmotnosť                    | 1,73 kg                |
| Batéria                     | 3,0 Ah                 |

obj.č. 57-0835



1-70-349  
TOUGH SYSTEM = vozík s držiakmi  
+ DS150 + DS300 + DS400

obj.č. 57-1749



ELEKTRONÁRADIE

| DC740KA<br>12V vŕtačka 2 x aku NiCD / 1,3 Ah - 20Nm |                      |
|---|----------------------|
| Napájacie napätie                                   | 12 V                 |
| Kapacita skľučovadla                                | 1-10 mm              |
| Výkon   | 190 W                |
| Otáčky naprázdno                                    | 0-350/0-1200 ot./min |
| Max. krútiaci moment                                | 26 Nm                |
| Max. priemer otvoru [drevo]                         | 25 mm                |
| Max. priemer otvoru [kov]                           | 10 mm                |
| Hmotnosť  | 1.7 kg               |
| Batéria   | NiCd 1,3 Ah          |

obj.č. 57-0740



**DCF610S2**  
**10,8 V skrutkovač 2 x Li-Ion 1,5 Ah / 6 Nm**

|                      |                |
|----------------------|----------------|
| Napájacie napätie    | 10,8 V         |
| Batéria              | 1.5 Ah         |
| Držiak nástrojov     | 6,35 mm        |
| Výkon                | 154 W          |
| Otáčky naprázdno     | 0-1050 ot./min |
| Max. krútiaci moment | 8 Nm           |
| Hmotnosť             | 0,96 kg        |

obj.č. 57-6102

**DCD710S2**  
**10,8 V dvojrýchlostná vŕtačka  
bez batérii a nabíjačky**

|                      |                |
|----------------------|----------------|
| Napájacie napätie    | 10,8 V         |
| Batéria              | 1.5 Ah         |
| Držiak nástrojov     | 6,35 mm        |
| Výkon                | 154 W          |
| Otáčky naprázdno     | 0-1050 ot./min |
| Max. krútiaci moment | 8 Nm           |
| Hmotnosť             | 0,96 kg        |

obj.č. 57-3710

**DW040P**  
**Laserový merač vzdialenosti - dosah 40 m**

|   |                                    |
|---|------------------------------------|
| Trieda laseru                               | 2                                  |
| Presnosť zrovnávania                        | 3 mm na 40 m                       |
| Rozsah automatického zrovnávania            | N/A °                              |
| Počet lúčov                                 | 1                                  |
| Smer lúčov                                  | N/A                                |
| Viditeľnosť laseru pri použití v miestnosti | 40 m                               |
| Napájanie                                   | 2 Batéria LR03 1,5 V (veľkosť AAA) |
| Pripojenie stojanu                          | N/A                                |
| Hmotnosť (s batériami)                      | 150 kg                             |

obj.č. 57-2040

**DW075PK**  
**Samonivelačný horizontálny  
a vertikálny laser - kompletná sada**

|   |                    |
|---|--------------------|
| Trieda laseru                               | 3R, < 5 mW         |
| Presnosť zrovnávania                        | +/- 0,2 mm/m       |
| Rozsah automatického zrovnávania            | +/- 5 °            |
| Viditeľnosť laseru pri použití v miestnosti | 15 m               |
| Max. pracovný rozsah s prímačom             | 100 m              |
| Rýchlosť otáčania                           | 0, 60, 600 ot./min |
| Rozsah náklonu v smere osy X a Y            | - °                |
| Napájanie                                   | 2 x D              |
| Prípojenie stojanu                          | 5/8"               |

obj.č. 57-3075



**DW088KTRI**  
**laserový kríž - samonivelačný so statívom**

|   |                              |
|---|------------------------------|
| Trieda laseru                               | 2, < 1 mW                    |
| Presnosť                                    | +/- 0,3 mm/m                 |
| Počet lúčov                                 | 2                            |
| Směr lúčov                                  | vertikální /<br>horizontální |
| Viditeľnosť laseru pri použití v miestnosti | 10 m                         |
| Rozsah automatického zrovnávania            | +/-4 °                       |
| Napájanie                                   | 4,5 V - 3 batéria AA         |
| Prípojenie stojanu                          | 1/4"                         |
| Hmotnosť (s batériami)                      | 0,46 kg                      |

obj.č. 57-0088



**DW089KD**  
**Multi Line Laser - samonivelačný  
s prijímačom DE0892**

|   |                              |
|---|------------------------------|
| Trieda laseru                               | 2, < 1 mW                    |
| Presnosť                                    | +/- 0,3 mm/m                 |
| Počet lúčov                                 | 3                            |
| Směr lúčov                                  | vertikální /<br>horizontální |
| Viditeľnosť laseru pri použití v miestnosti | 15 m                         |
| Rozsah automatického zrovnávania            | +/-4 °                       |
| Napájanie                                   | 4,5 V - 3 batéria AA         |
| Prípojenie stojanu                          | 1/4"                         |
| Hmotnosť (s batériami)                      | 0,8 kg                       |

obj.č. 57-1089





| <b>D21721K</b><br>prilepová vŕtačka 650W/2 rýchlosti<br>/rychloupínacie skľučovadlo/ kufor |                                |
|--|--------------------------------|
| Kapacita skľučovadla   | 1,5-13 mm                      |
| Príkion  | 650 W                          |
| Výkon  | 325 W                          |
| Max. krútiaci moment   | 30/12 Nm                       |
| Otáčky naprázdno   | 0-1100 / 0-2600 ot./min        |
| Úderov/min   | 0-19000 / 0-44200 ú/min        |
| Max. priemer otvoru [drevo]  | 40/25 mm                       |
| Max. priemer otvoru [ocel']  | 13 mm                          |
| Max. priemer otvoru [betón]  | 16 mm                          |
| Závit vretena  | 1/2" x 20 jednotný jemný závit |
| Hmotnosť   | 2.1 kg                         |

obj.č. 57-2172



| <b>DWD014S</b><br>10 mm vŕtačka s rychloupínacím<br>skľučovadlom, 550 W |                                |
|---|--------------------------------|
| Kapacita skľučovadla  | 1,0-10 mm                      |
| Príkion   | 550 W                          |
| Výkon   | 269 W                          |
| Max. krútiaci moment  | 7,9 Nm                         |
| Otáčky naprázdno  | 0-2800 ot./min                 |
| Max. priemer otvoru [drevo]   | 25 mm                          |
| Max. priemer otvoru [ocel']   | 10 mm                          |
| Závit vretena   | 1/2" X 20 jednotný jemný závit |
| Hmotnosť  | 1,34 kg                        |

obj.č. 57-7014



| <b>D024</b><br>13 mm vŕtačka s príklepom, 650 W |                                |
|---|--------------------------------|
| Kapacita skľučovadla                            | 1,5-13 mm                      |
| Príkion   | 650 W                          |
| Výkon   | 302 W                          |
| Max. krútiaci moment                            | 8,6 Nm                         |
| Otáčky naprázdno                                | 0-2800 ot./min                 |
| Úderov/min                                      | 0-47600 ú/min                  |
| Max. priemer otvoru [drevo]                     | 25 mm                          |
| Max. priemer otvoru [ocel']                     | 13 mm                          |
| Max. priemer otvoru [betón]                     | 16 mm                          |
| Závit vretena                                   | 1/2" x 20 jednotný jemný závit |
| Hmotnosť  | 1,82 kg                        |

obj.č. 57-1024

| <b>D25013K</b><br><b>2 kg kombinované kladivo,</b><br><b>650 W, 1,8 J*, 2,4 kg</b> |                |
|--|----------------|
| Príkon   | 650 W          |
| Výkon  | 300 W          |
| Otáčky naprázdno   | 0-1550 ot./min |
| Úderov/min   | 0-4550 ú/min   |
| Energia úderu ( EPTA/2009 )  | 1.8 J          |
| Držiak nástrojov   | SDS-Plus       |
| Max. priemer otvoru [drevo]  | 30 mm          |
| Max. priemer otvoru [kov]  | 13 mm          |
| Max. priemer otvoru [betón]  | 22 mm          |
| Max. priemer otvoru [vrtacia korunka]  | 50 mm          |
| Hmotnosť   | 2,3 kg         |

obj.č. 57-5013



| <b>D25123K</b><br><b>2 kg kombi kladivo 800W, 2,8 J*, 2,6 kg</b> |                |
|--|----------------|
| Príkon   | 800 W          |
| Výkon  | 395 W          |
| Otáčky naprázdno   | 0-1150 ot./min |
| Úderov/min   | 0-4300 ú/min   |
| Energie úderu ( EPTA/2009 )                                      | 2.8 J          |
| Držiak nástrojov   | SDS-Plus       |
| Max. priemer otvoru [drevo]                                      | 30 mm          |
| Max. priemer otvoru [kov]  | 13 mm          |
| Max. priemer otvoru [betón]                                      | 26 mm          |
| Max. priemer otvoru [vrtacia korunka]                            | 65 mm          |
| Hmotnosť   | 2,9 kg         |

obj.č. 57-5123



| <b>D25323K</b><br><b>3kg kombi kladivo s AVC 800 W, 2,8 J*, 3,4 kg</b> |                |
|--|----------------|
| Príkon   | 800 W          |
| Výkon  | 395 W          |
| Otáčky naprázdno   | 0-1150 ot./min |
| Úderov/min   | 0-4300 ú/min   |
| Energie úderu ( EPTA/2009 )  | 2.8 J          |
| Držiak nástrojov   | SDS-Plus       |
| Max. priemer otvoru [drevo]  | 30 mm          |
| Max. priemer otvoru [kov]  | 13 mm          |
| Max. priemer otvoru [betón]  | 26 mm          |
| Max. priemer otvoru [vrtacia korunka]                                  | 65 mm          |
| Hmotnosť   | 3.4 kg         |

obj.č. 57-5323



**D25601K**  
**6kg kombi kladivo SDS-Max 1 250W,**  
**2-8 J\*, 6,8 kg, AVC**

|  |                 |
|--|-----------------|
| Príkon                                 | 1250 W          |
| Výkon                                  | 615 W           |
| Otáčky pri zaťažení                    | 210-415 ot./min |
| Úderov/min                             | 1430-2840 ú/min |
| Energie úderu ( EPTA/2009 )            | 8 J             |
| Držiak nástrojov                       | SDS-Max         |
| Max. priemer otvoru [betón]            | 45 mm           |
| Max. priemer otvoru [prierazový vrták] | 65 mm           |
| Max. priemer otvoru [vrtacia korunka]  | 100 mm          |
| Hmotnosť                               | 6,8 kg          |

obj.č. 57-5601

**D23620**  
**1 150W, prierez 65mm, 5,1 kg**

|  |                  |
|--|------------------|
| Príkon   | 1150 W           |
| Výkon  | 570 W            |
| Otáčky naprázdno                               | 5000 ot./min     |
| Priemer kotúča                                 | 184 mm           |
| Priemer upínacího otvoru kotúča                | 16 mm            |
| Kapacita šikmých rezov                         | 50 °             |
| Max. hĺbka rezu pri 90°                        | 65 mm            |
| Max. hĺbka rezu pri 90°<br>(s vodiacou lištou) | nieje uvedené mm |
| Max. hĺbka rezu pri 45°                        | 45 mm            |
| Max. hĺbka rezu pri 45°<br>(s vodiacou lištou) | nieje uvedené mm |
| Hmotnosť                                       | 5.1 kg           |

obj.č. 57-3620

**D23650K**  
**1 350W, prierez 65mm, 5,4 kg + kufor**

|  |              |
|--|--------------|
| Príkon   | 1350 W       |
| Výkon  | 800 W        |
| Otáčky naprázdno                               | 5000 ot./min |
| Priemer kotúča                                 | 190 mm       |
| Priemer upínacího otvoru kotúča                | 30 mm        |
| Kapacita šikmých rezov                         | 55 °         |
| Max. hĺbka rezu pri 90°                        | 65 mm        |
| Max. hĺbka rezu pri 90°<br>(s vodiacou lištou) | 61 mm        |
| Max. hĺbka rezu pri 45°                        | 45 mm        |
| Max. hĺbka rezu pri 45°<br>(s vodiacou lištou) | 41 mm        |
| Hmotnosť                                       | 5.4 kg       |

obj.č. 57-3650

**DW331K**

**701W, prierez 135m, 2,8 kg**

|                                    |              |
|------------------------------------|--------------|
| Príkonnosť                         | 701 W        |
| Výkon                              | 445 W        |
| Počet zdvihov naprázdno            | 0-3100 k/min |
| Dĺžka zdvihu                       | 26 mm        |
| Kapacita šikmých rezov             | 45 °         |
| Max. rezná kapacita (drevo)        | 135 mm       |
| Max. rezná kapacita (ocel)         | 12 mm        |
| Max. rezná kapacita (farebné kovy) | 30 mm        |
| Hmotnosť                           | 2.8 kg       |

obj.č. 57-0331



**DW341K**

**550W, prierez 85mm, 2,0 kg**

|                                    |              |
|------------------------------------|--------------|
| Príkonnosť                         | 550 W        |
| Výkon                              | 350 W        |
| Počet zdvihov naprázdno            | 0-3100 k/min |
| Dĺžka zdvihu                       | 20 mm        |
| Kapacita šikmých rezov             | 45 °         |
| Max. rezná kapacita (drevo)        | 85 mm        |
| Max. rezná kapacita (ocel)         | 10 mm        |
| Max. rezná kapacita (farebné kovy) | 20 mm        |
| Hmotnosť                           | 2.0 kg       |

obj.č. 57-0341



**DW393**

**univerzálna píla 425mm na tehly  
do pevnostnej triedy 12**

|                             |            |
|-----------------------------|------------|
| Príkonnosť                  | 1350 W     |
| Výkon                       | 700 W      |
| Počet zdvihov naprázdno     | 3300 k/min |
| Dĺžka zdvihu                | 38 mm      |
| Dĺžka rezného nástroja      | 425 mm     |
| Zastavenie rezného nástroja | 3 s        |
| Hmotnosť                    | 4.3 kg     |

obj.č. 57-0393



**D28132C**  
125mm, 1 200W, 1,7kg, odfuk

|                     |               |
|---------------------|---------------|
| Príkon              | 1200 W        |
| Otáčky naprázdno    | 10000 ot./min |
| Max. priemer kotúča | 125 mm        |
| Závit vretena       | M14           |
| Hmotnosť            | 2.5 kg        |

obj.č. 57-8132

**D28490**  
230mm, 2 000W, 4,6kg

|                     |              |
|---------------------|--------------|
| Príkon              | 2000 W       |
| Výkon               | 1054 W       |
| Otáčky naprázdno    | 6500 ot./min |
| Max. priemer kotúča | 230 mm       |
| Závit vretena       | M14          |
| Hmotnosť            | 5.5 kg       |

obj.č. 57-8490

**DW433**  
800W, pás 533 x 75mm, 5,6 kg - elektronika

|               |                 |
|---------------|-----------------|
| Príkon        | 800 W           |
| Výkon         | 360 W           |
| Rýchlosť pásu | 259 - 427 m/min |
| Rozmer pásu   | 75 x 533 mm     |
| Brúsna plocha | 75 x 140 mm     |
| Hmotnosť      | 5,6 kg          |

obj.č. 57-0433

**D26453**  
päšná brúska 125mm, rozkmit 2,4mm,  
1,6 kg - elektronika

|                         |                    |
|-------------------------|--------------------|
| Príkon                  | 280 W              |
| Výkon                   | 120 W              |
| Rýchlosť otáčania       | 7000-12000 ot./min |
| Kmitov/min              | 14000-24000 k/min  |
| Rozkmit                 | 2.4 mm             |
| Rozmer brúsneho papiera | 125 mm             |
| Hmotnosť                | 1.6 kg             |

obj.č. 57-6453



**Teplovzdušná pištoľ s digitálnym ukazovateľom teploty D 26414**

|                  |                |
|------------------|----------------|
| Príkon           | 2000W          |
| Pracovná teplota | 50-400/600 st. |
| Prietok vzduchu  | 240/500 l/min  |
| Hmotnosť         | 0,9 kg         |

obj.č. 57-2641



**DW-682K, FRÉZA LAMELOVACIA**

|                        |             |
|------------------------|-------------|
| Príkon                 | 600 W       |
| Výkon                  | 335 W       |
| Otáčky naprázdno       | 10000 min-1 |
| Max. priemer nástroja  | 100 mm      |
| Max. rezná hĺbka       | 20 mm       |
| Nastavenie pravítka    | 0 – 90°     |
| Nastavenie drážkovania | 4 mm        |
| Hmotnosť               | 3,0 kg      |

obj.č. 57-0682



**DW621  
1 100W, zdvih 55mm, klieštiny 6-8mm, 3,1 kg**

|                       |                    |
|-----------------------|--------------------|
| Príkon                | 1100 W             |
| Výkon                 | 620 W              |
| Otáčky naprázdno      | 8000-24000 ot./min |
| Zdvih                 | 55 mm              |
| Rozmer klieštiny      | 6-8 mm             |
| Max. priemer nástroja | 36 mm              |
| Hmotnosť              | 3.1 kg             |

obj.č. 57-0621





| <b>DW625E</b><br>2 000W, zdvih 80mm, 5,1 kg |                    |
|---|--------------------|
| Príkonn                                     | 2000 W             |
| Výkon                                       | 1400 W             |
| Otáčky naprázdno                            | 8000-20000 ot./min |
| Zdvih                                       | 80 mm              |
| Rozmer klieštiny                            | 6-12,7 mm          |
| Max. priemer nástroja                       | 50 mm              |
| Hmotnosť                                    | 5.1 kg             |

obj.č. 57-0625



| <b>DW716EXPS</b><br>pokosová píla 1 600W, max. rezy 203 x 152 mm<br>- elektronika + XPS svetelný systém |                     |
|---|---------------------|
| Príkonn   | 1600 W              |
| Výkon   |                     |
| Otáčky kotúča   | 1900 - 3600 ot./min |
| Priemer kotúča  | 305 mm              |
| Priemer upínacieho otvoru kotúča  | 30 mm               |
| Kapacita šikmých rezov  | 50/50 °             |
| Max. kapacita pokosového rezu (vpravo/vľavo)  | 50/50 °             |
| Max. kapacita pri nastavení 90°/90° (šírka x výška)   | 190 x 85 mm         |
| Max. kapacita pri nastavení 90°/90° (šírka x výška)   | 203 x 72 mm         |
| Max. kapacita pri nastavení 45°/90° (šírka x výška)   | 134 x 85 mm         |
| Max. kapacita pri nastavení 45°/90° (šírka x výška)   | 142 x 72 mm         |
| Max. kapacita pri nastavení 90°/45° (šírka x výška)   | 190 x 56 mm         |
| Max. kapacita pri nastavení 90°/45° (šírka x výška)   | 203 x 47 mm         |
| Max. rezná kapacita 45° / 45°   | 142 x 47 mm         |
| Max. hĺbka rezu [píly]  | 152 mm              |
| Hmotnosť  | 18 kg               |

obj.č. 57-0716

**DWS780**  
**pokosová píla s výsuvom 1 675W, max. rezy**  
**303 x 110 mm + XPS svetelný systém**

|   |                     |
|---|---------------------|
| Prikon  | 1675 W              |
| Výkon   | 960 W               |
| Otáčky kotúča                                       | 1900 - 3800 ot./min |
| Priemer kotúča                                      | 305 mm              |
| Priemer upínacieho otvoru kotúča                    | 30 mm               |
| Kapacita šikmých rezov                              | 49/49 °             |
| Max. kapacita pokosového rezu (vpravo/vlevo)        | 60/50 °             |
| Max. kapacita pri nastavení 90°/90° (šírka x výška) | 50 x 163 mm         |
| Max. kapacita pri nastavení 90°/90° (šírka x výška) | 3 mm                |
| Max. kapacita pri nastavení 45°/90° (šírka x výška) | 2 mm                |
| Max. kapacita pri nastavení 45°/90° (šírka x výška) | 2 mm                |
| Max. kapacita pri nastavení 90°/45° (šírka x výška) | 3 mm                |
| Max. kapacita pri nastavení 90°/45° (šírka x výška) | 3 mm                |
| Max. rezná kapacita 45° / 45°                       | 2 mm                |
| Max. hĺbka rezu [pily]                              | 170 mm              |
| Hmotnosť  | 24.8 kg             |

obj.č. 57-2780



**DW743N**  
**kombinovaná píla TGS 2 000W, 20,3 kg**

|   |              |
|---|--------------|
| Prikon  | 2000 W       |
| Výkon   | 1550 W       |
| Otáčky kotúča                                       | 2850 ot./min |
| Priemer kotúča                                      | 250 mm       |
| Priemer upínacieho otvoru kotúča                    | 30 mm        |
| Kapacita šikmých rezov                              | 45 °         |
| Max. kapacita pokosového rezu (vpravo/vlevo)        | 45 / 45 °    |
| Max. kapacita pri nastavení 90°/90° (šírka x výška) | 140 x 68 mm  |
| Max. kapacita pri nastavení 90°/90° (šírka x výška) | 180 x 20 mm  |
| Max. kapacita pri nastavení 45°/90° (šírka x výška) | 95 x 70 mm   |
| Max. kapacita pri nastavení 45°/90° (šírka x výška) | 120 x 46 mm  |
| Max. kapacita pri nastavení 90°/45° (šírka x výška) | 70 x 95 mm   |
| Max. kapacita pri nastavení 90°/45° (šírka x výška) | 150 x 20 mm  |
| Max. rezná kapacita 45° / 45°                       | - mm         |
| Max. rezná kapacita [stolná kotúčová píla 90°/90°]  | 0 - 70 mm    |
| Max. rezná kapacita [stolná kotúčová píla 90°/45°]  | 0 - 32 mm    |
| Hmotnosť  | 37 kg        |

obj.č. 57-0743



**DW744XP**  
stolová píla 2 000W, 29kg, prierez 622 x 77 mm

|                                  |              |
|----------------------------------|--------------|
| Príkon                           | 2000 W       |
| Výkon                            | 1600 W       |
| Otáčky kotúča                    | 3000 ot./min |
| Priemer kotúča                   | 250 mm       |
| Priemer upínacieho otvoru kotúča | 30 mm        |
| Kapacita šikmých rezov           | -3 až 48 °   |
| Max. rezná kapacita [vpravo]     | 625 mm       |
| Max. rezná kapacita [vľavo]      | 342 mm       |
| Max. hĺbka rezu pri 90°          | 77 mm        |
| Max. hĺbka rezu pri 45°          | 57 mm        |
| Rozmery stolu                    | 627 x 678 mm |
| Hmotnosť                         | 35 kg        |

obj.č. 57-0744

**D26500K**  
Hoblík

|                      |               |
|----------------------|---------------|
| Príkon               | 1050 W        |
| Výkon                | 620 W         |
| Otáčky naprázdno     | 13500 ot./min |
| Maximálna hĺbka rezu | 4 mm          |
| Hĺbka falcovania     | 25 mm         |
| Šírka hoblíku        | 82 mm         |
| Dĺžka základne       | 320 mm        |
| Priemer valca        | 64 mm         |
| Hmotnosť             | 4.0 kg        |

obj.č. 57-6500

**DW-D26441QS, BRÚSKA VIBRAČNÁ**

|                         |                          |
|-------------------------|--------------------------|
| Príkon                  | 230 W                    |
| Výkon                   | 120 W                    |
| Kmity za min.           | 28 000 min <sup>-1</sup> |
| Rýchlosť otáčania       | 14 000 min <sup>-1</sup> |
| Rozkmit                 | 1,4 mm                   |
| Rozmer brúsneho papiera | 140 x 115 mm             |
| Hmotnosť                | 1,4 kg                   |

obj.č. 57-6441

| DW-D28139, BRÚSKA UHL. D125MM |             |
|-------------------------------|-------------|
| Príkion                       | 850 W       |
| Maximálny priemer kotúča      | 125 mm      |
| Otáčky naprázdno              | 10000 min-1 |
| Dĺžka × výška                 | 270 × 80 mm |
| Hmotnosť                      | 2,1 kg      |

obj.č. 57-8139

| DW-D28141QS, BRÚSKA UHL. D150MM |            |
|---------------------------------|------------|
| Príkion                         | 1400 W     |
| Priemer kotúča                  | 150 mm     |
| Otáčky naprázdno                | 9000 min-1 |
| Dĺžka                           | 300 mm     |
| Hmotnosť                        | 2,6 kg     |

obj.č. 57-8141

| Dewalt D28134KD set, uhlová brúska |             |
|------------------------------------|-------------|
| Príkion                            | 1100 W      |
| Energetické vlastnosti             | 300 mm      |
| Priemer kotúča                     | 125 mm      |
| Voľnobežné otáčky                  | 10 000 /min |
| Hmotnosť                           | 2,2 kg      |

obj.č. 07-1173314



**Vibračná brúska RTS 400**

|                               |                   |
|-------------------------------|-------------------|
| Príkonnosť                    | 200 W             |
| Počet otáčok                  | 6000-14000 min-1  |
| Pracovné zdvihy               | 12000-28000 min-1 |
| Brúsny zdvih                  | 2 mm              |
| Vymeniteľná brúsna doska      | 80 x 130 mm       |
| Prípojky pre odsávanie prachu | 27 mm             |
| Hmotnosť                      | 1,1 kg            |

obj.č. 98-567860

**Vibračná brúska RUTSCHER RS 300**

|                               |                  |
|-------------------------------|------------------|
| Príkonnosť                    | 280 W            |
| Počet otáčok                  | 4000-10000 min-1 |
| Brúsny zdvih                  | 2,4 mm           |
| Vymeniteľná brúsna doska      | 93 x 175 mm      |
| Prípojky pre odsávanie prachu | 27 mm            |
| Hmotnosť                      | 2,3 kg           |

obj.č. 98-567848

**Vibračná brúska Delta DTS 400**

|                               |                  |
|-------------------------------|------------------|
| Príkonnosť                    | 200 W            |
| Počet otáčok                  | 6000-14000 min-1 |
| Brúsny zdvih                  | 2 mm             |
| Vymeniteľná brúsna doska      | 100 x 150 mm     |
| Prípojky pre odsávanie prachu | 27 mm            |
| Hmotnosť                      | 1,1 kg           |

obj.č. 98-567868

#### Priamočiara píla TRION PS 300

|                                   |                 |
|-----------------------------------|-----------------|
| Príkion                           | 720 W           |
| Ppočet zdvihov                    | 1000-2900 min-1 |
| Stupňová regulácia kyvného zdvíhu | 4               |
| Šikmá poloha                      | 0-45°           |
| Hĺbka rezu v dreve                | 120 mm          |
| Hĺbka rezu - neželezný kov        | 20 mm           |
| Hĺbka rezu - oceľ (mäkká)         | 10 mm           |
| Hmotnosť                          | 2,4 kg          |

obj.č. 98-567868



#### Excentrická brúska s prevodovkou ROTEX RO 90

|                                       |                 |
|---------------------------------------|-----------------|
| Príkion                               | 400 W           |
| Počet otáčok - rotačný pohyb<br>ROTEX | 260-520 min-1   |
| Počet otáčok - excentrický pohyb      | 3500-7000 min-1 |
| Brúsny zdvih                          | 3 mm            |
| Brúsny tanier FastFix                 | 90 mm           |
| Prípojky pre odsávanie prachu         | 27 mm           |
| Hmotnosť                              | 1,5 kg          |

obj.č. 98-571819



#### Lineárna brúska DUPLEX LS 130

|                               |                    |
|-------------------------------|--------------------|
| Príkion                       | 260 W              |
| Počet otáčok                  | 4000-6000 min-1    |
| Pracovní zdvihy               | 8000 - 12000 min-1 |
| Brúsny zdvih                  | 4 mm               |
| Vymeniteľná brúsna doska      | 133 x 80 mm        |
| Prípojky pre odsávanie prachu | 27 mm              |
| Hmotnosť                      | 1,7 kg             |

obj.č. 98-567850



**Priamočiara píla TRION PSB 300**

|                          |          |
|--------------------------|----------|
| Príkonnosť               | 550 W    |
| Počet zdvihov            | 3100/min |
| Nastavenie šikmých rezov | 0-45 st. |
| Hĺbka rezu drevo         | 100 mm   |
| Neželezné kovy           | 26 mm    |
| Hmotnosť                 | 2,4 kg   |

obj.č. 98-561125

**Rotačne-excentrická brúska ROTEX RO 125**

|                                    |                 |
|------------------------------------|-----------------|
| Príkonnosť                         | 500 W           |
| Počet otáčok - rotačný pohyb ROTEX | 300-600 min-1   |
| Počet otáčok - excentrický pohyb   | 3000-6000 min-1 |
| Brúsny zdvih                       | 3,6 mm          |
| Brúsny tanier FastFix              | 125 mm          |
| Prípojky pre odsávanie prachu      | 27 mm           |
| Hmotnosť                           | 1,9 kg          |

obj.č. 98-571533

**Excentrická brúska ETS 150/3**

|                                  |                  |
|----------------------------------|------------------|
| Príkonnosť                       | 310 W            |
| Počet otáčok - excentrický pohyb | 4000-10000 min-1 |
| Brúsny zdvih                     | 3 mm             |
| Vymeniteľný brúsny tanier        | 150 mm           |
| Prípojky pre odsávanie prachu    | 27 mm            |
| Hmotnosť                         | 1,8 kg           |

obj.č. 98-571787



| Excentrická brúska ETS 150/5     |                              |
|----------------------------------|------------------------------|
| Príkonná výkon                   | 310 W                        |
| Počet otáčok - excentrický pohyb | 4000-10000 min <sup>-1</sup> |
| Brúsny zdvih                     | 5 mm                         |
| Výmeniteľný brúsny tanier        | 150 mm                       |
| Prípojky pre odsávanie prachu    | 27 mm                        |
| Hmotnosť                         | 1,8 kg                       |

obj.č. 98-571795



| Priamočiara píla CARVEX PSC 400 Li 15 |                             |
|---------------------------------------|-----------------------------|
| Napätie akumulátoru                   | 14,4 V                      |
| Počet zdvihov                         | 1500-3800 min <sup>-1</sup> |
| Stupňovitá regulácia kyvného zdvíhu   | 4                           |
| Hĺbka rezu ve dreve                   | 120 mm                      |
| Hĺbka rezu - neželezný kov            | 20 mm                       |
| Hĺbka rezu - ocel' (mäkká)            | 10 mm                       |
| Kapacita akumulátoru                  | 2,6 Ah                      |
| Hmotnosť                              | 2,3 kg                      |

obj.č. 98-561403



| Rotačne-excentrická brúska ROTEX R0 150 |                             |
|---|-----------------------------|
| Príkonná výkon                          | 720 W                       |
| Počet otáčok - rotačný pohyb ROTEX      | 320-660 min <sup>-1</sup>   |
| Počet otáčok - excentrický pohyb        | 3300-6800 min <sup>-1</sup> |
| Brúsny zdvih                            | 5 mm                        |
| Brúsny tanier FastFix                   | 150 mm                      |
| Prípojky pre odsávanie prachu           | 27 mm                       |
| Hmotnosť                                | 2,3 kg                      |

obj.č. 98-571805



**Jednoručný hoblík EHL 65**

|                                  |                         |
|----------------------------------|-------------------------|
| Príkonný výkon                   | 720 W                   |
| Počet otáčok hobľovacej hriadele | 15600 min <sup>-1</sup> |
| Šírka hobľovacieho záberu        | 65 mm                   |
| Úber materiálu                   | 0-4 mm                  |
| Max. hĺbka drážky                | 23 mm                   |
| Prípojky pre odsávanie prachu    | 27 mm                   |
| Hlučnosť pri volnobehu           | 76 dB(A)                |
| Hmotnosť                         | 2,4 kg                  |

obj.č. 98-574530

**Pásová brúska BS 75**

|                                      |               |
|--------------------------------------|---------------|
| Príkonný výkon                       | 1010 W        |
| Rýchlosť pásu pri menovitom zaťažení | 200-380 m/min |
| Šírka pásu                           | 75 mm         |
| Dĺžka brúsneho pásu                  | 533 mm        |
| Brúsna plocha                        | 135 x 75 mm   |
| Prípojky pre odsávanie prachu        | 27/36 mm      |
| Hmotnosť                             | 3,8 kg        |

obj.č. 98-570207

**Príamočiara píla PSBC 400**

|                          |               |
|--------------------------|---------------|
| Napätie akumulátora      | 18 V          |
| Počet zdvihov            | 1000-3800/min |
| Nastavenie šikmých rezov | 0-45 st.      |
| Hĺbka rezu v dreve       | 120 mm        |
| Neželezné kovy           | 20 mm         |
| Oceľ (mäkká)             | 10 mm         |
| Kapacita akku            | 2,6 Ah        |
| Hmotnosť                 | 2,4 kg        |

obj.č. 98-561535

#### Priamočiara píla CARVEX PS 400

|                                     |                 |
|-------------------------------------|-----------------|
| Príkonnosť                          | 500 W           |
| Počet zdvihov                       | 1500-3800 min-1 |
| Stupňovitá regulácia kyvného zdvíhu | 4               |
| Hĺbka rezu v dreve                  | 120 mm          |
| Hĺbka rezu - neželezný kov          | 20 mm           |
| Hĺbka rezu - oceľ (mäkká)           | 10 mm           |
| Hmotnosť                            | 1,9 kg          |

obj.č. 98-561488



#### Elektrický ručný hoblík HL 850

|                                  |             |
|----------------------------------|-------------|
| Príkonnosť                       | 850 W       |
| Počet otáčok hoblovacej hriadele | 11000 min-1 |
| Šírka hoblovacieho záberu        | 82 mm       |
| Úber materiálu                   | 0-3,5 mm    |
| Prípojky pre odsávanie prachu    | 36 mm       |
| Hlučnosť pri voľnobehu           | 79 dB(A)    |
| Hmotnosť                         | 3,9 kg      |

obj.č. 98-574550



#### Pásová brúska BS 105

|                                      |               |
|--------------------------------------|---------------|
| Príkonnosť                           | 1400 W        |
| Rýchlosť pásu pri menovitom zaťažení | 230-380 m/min |
| Šírka pásu                           | 105 mm        |
| Dĺžka brusného pásu                  | 620 mm        |
| Brúsna plocha                        | 160 x 105 mm  |
| Prípojky pre odsávanie prachu        | 27/36 mm      |
| Hmotnosť                             | 6,5 kg        |

obj.č. 98-570212



#### Ponorná píla TS 75

|                               |                 |
|-------------------------------|-----------------|
| Príkonnosť                    | 1600 W          |
| Voľnobežné otáčky             | 1350-3550 min-1 |
| Priemer pilového kotúča       | 210 mm          |
| Hĺbka rezu                    | 0-75 mm         |
| Hĺbka rezu pri 45°            | 55 mm           |
| Hĺbka rezu pri 45°/90°        | 0-55/0-75 mm    |
| Šikmá poloha                  | 0-47 °          |
| Prípojky pre odsávanie prachu | 27/36 mm        |
| Hmotnosť                      | 6,2 kg          |

obj.č. 98-561512



**Akuskrutkovač T 12+3**

|  |                                |
|--|--------------------------------|
| Napätie akumulátoru                          | 10,8 V                         |
| Voľnobežné otáčky 1./2. rýchlosť             | 0-450/0-1500 min <sup>-1</sup> |
| Priemer vrtania drevo/ocel'                  | 25/14 mm                       |
| Nastavenie krútiaceho momentu 1./2. rýchlosť | 0,5-8/0,5-6 Nm                 |
| Max. krútiaci moment drevo/ocel'             | 20/34 Nm                       |
| Upínací rozsah skľučovadla                   | 1,5-13 mm                      |
| Kapacita akumulátoru Li-Ion                  | 3,0 Ah                         |
| Doba nabíjania lithium-iontového akumulátoru | 45 min                         |
| Hmotnosť s lithium-iontovým akumulátorom     | 1,4 kg                         |

obj.č. **98-564378**
**Akumulátorový rázový uťahovák TI 15 IMPACT**

|  |                             |
|--|-----------------------------|
| Napätie akumulátoru                          | 14,4 V                      |
| Voľnobežné otáčky                            | 0-2600 min <sup>-1</sup>    |
| Počet úderov                                 | 2400-3600 min <sup>-1</sup> |
| Max. krútiaci moment v kovu                  | 100 Nm                      |
| Upínací rozsah skľučovadla                   | 1,5-13 mm                   |
| Priemer vrtania drevo/ocel'                  | 13/10 mm                    |
| Kapacita akumulátoru Li-Ion                  | 3,0 Ah                      |
| Doba nabíjania lithium-iontového akumulátoru | 45 min                      |
| Hmotnosť s lithium-iontovým akumulátorom     | 1,7 kg                      |

obj.č. **98-564354**
**Akuskrutkovač C 15 Li**

|  |                                |
|--|--------------------------------|
| Napätie akumulátoru                          | 14,4 V                         |
| Voľnobežné otáčky 1./2. rýchlosť             | 0-450/0-1500 min <sup>-1</sup> |
| Priemer vrtania drevo/ocel'                  | 35/16 mm                       |
| Nastavenie krútiaceho momentu 1./2. rýchlosť | 0,5-8/0,5-6 Nm                 |
| Max. krútiaci moment drevo/ocel'             | 25/40 Nm                       |
| Upínací rozsah skľučovadla                   | 1,5-13 mm                      |
| Kapacita akumulátoru Li-Ion                  | 3,0 Ah                         |
| Doba nabíjania lithium-iontového akumulátoru | 45 min                         |
| Hmotnosť s lithium-iontovým akumulátorom     | 1,6 kg                         |

obj.č. **98-564371**

#### Akumulátorový vŕtací skrutkovač T 15+3

|                                       |              |
|---------------------------------------|--------------|
| Napätie akumulátora                   | 14,4V        |
| Voľnobežné otáčky 1.st/2.st           | 0-450/0-1500 |
| Priemer vŕtania drevo/ocel'           | 35/16mm      |
| Nast. krút. momentu 1.rýchl./2.rýchl. | 0,5-8Nm/8Nm  |
| Max. krút. momentu drevo/ocel'        | 27/40 Nm     |
| Upínací rozsah skľučovadla            | 1,5-13 mm    |
| Kapacita akku                         | 3,0 Ah       |
| Doba nabíjania                        | 45 min       |
| Hmotnosť                              | 1,5 kg       |

obj.č. 98-564308



#### Leštička RAP 150FE

|                       |               |
|-----------------------|---------------|
| Príkon                | 1200 W        |
| Voľnobežné otáčky     | 400-2100 /min |
| Leštiaci tanier       | 150 mm        |
| Upínací závit taniera | M14           |
| Hmotnosť              | 2,1 kg        |

obj.č. 98-570762



#### Leštička POLLUX 180

|                       |               |
|-----------------------|---------------|
| Príkon                | 1500W         |
| Voľnobežné otáčky     | 800-2400 /min |
| Leštiaci tanier       | 180 mm        |
| Upínací závit taniera | M14           |
| Hmotnosť              | 3,6 kg        |

obj.č. 98-570734



**Akumulátorový vŕtací skrutkovač CXS**

|                                   |                   |
|-----------------------------------|-------------------|
| Napätie akumulátora               | 10,8V             |
| Voľnobežné otáčky 1./2.rýchlosť   | 0-400/0-1200 /min |
| Priemer vŕtania drevo/ocel'       | 12/8 mm           |
| Nastavenie kr.momentu 1./2. rých. | 0,2-2,4 Nm        |
| Max. kr. moment drevo/ocel'       | 10/16 Nm          |
| Upínací priemer skľučovadla       | 1-8 mm            |
| Kapacita akumulátora              | 1,5 Ah            |
| Doba nabíjania                    | 20 min            |
| Hmotnosť                          | 0,9 kg            |

obj.č. 98-564271

**Multifunkčná hranová fréza MFK 700**

|                               |                   |
|-------------------------------|-------------------|
| Príkion                       | 720 W             |
| Voľnobežné otáčky             | 10000-26000 min-1 |
| Priemer klieštiny             | 6-8 mm            |
| Jemné nastavenie hĺbky fréz   | 14 mm             |
| Priemer frézy max.            | 32 mm             |
| Prípojky pre odsávanie prachu | 27 mm             |
| Hmotnosť                      | 1,9 kg            |

obj.č. 98-574284

**Hranová fréza OFK 500**

|                               |             |
|-------------------------------|-------------|
| Príkion                       | 450 W       |
| Voľnobežné otáčky             | 28000 min-1 |
| Prípojky pre odsávanie prachu | 27 mm       |
| Hmotnosť                      | 1,4 kg      |

obj.č. 98-574355

| Hranová fréžka OFK 700                                  |                               |
|---|-------------------------------|
| Príkonná výkon  | 720 W                         |
| Voľnobežné otáčky                                       | 10000-26000 min <sup>-1</sup> |
| Priemer klieštiny                                       | 6-8 mm                        |
| Max. frézovacia hĺbka, vertikálne (1,5° náklon stolu)   | 9 mm                          |
| Max. frézovacia hĺbka, horizontálne (1,5° náklon stolu) | 5 mm                          |
| Max. šírka frézovania                                   | 14 mm                         |
| Prípojky pre odsávanie prachu                           | 27 mm                         |
| Hmotnosť  | 2 kg                          |

obj.č. 98-574359

| Spojovací systém DOMINO DF 500      |                         |
|-------------------------------------|-------------------------|
| Príkonná výkon                      | 420W                    |
| Voľnobežné otáčky                   | 24300/min               |
| Hĺbkový doraz pre                   | 12,15,20,25             |
| Nastavenie hĺbky                    | 28 mm                   |
| Priemer fréz                        | 4,5,6,8,10 mm           |
| Prestavenie fréz.výšky so stupnicou | 5-30 mm                 |
| Posuvný stupň. doraz                | 16,20,22,25,28,36,40 mm |
| Frézovanie v sklone                 | 0-90 st                 |
| Priemer ods. prípojky               | 27 mm                   |
| Hmotnosť                            | 3,2 kg                  |

obj.č. 98-574228

| Čapová fréžka DOMINO DF 700                   |                           |
|---|---------------------------|
| Príkonná výkon                                | 720 W                     |
| Voľnobežné otáčky                             | 21000 min <sup>-1</sup>   |
| Hĺbkový doraz pre nastavenie hĺbky frézovania | 15-70 mm                  |
| Frézy na výrezy DOMINO                        | 8, 10, 12, 14 mm          |
| Prestavenie frézovacej výšky                  | 10-50 mm                  |
| Posuvný stupňový doraz                        | 10, 15, 20, 25, 30, 40 mm |
| Frézovanie v sklone                           | 0-90 °                    |
| Prípojky pre odsávanie prachu                 | 27 mm                     |
| Hmotnosť                                      | 5,2 kg                    |

obj.č. 98-574320

| Horná fréžka OF 1010          |                               |
|-------------------------------|-------------------------------|
| Príkonná výkon                | 1010 W                        |
| Voľnobežné otáčky             | 10000-24000 min <sup>-1</sup> |
| Priemer klieštiny             | 6-8 mm                        |
| Rýchle prestavenie hĺbky fréz | 55 mm                         |
| Jemné nastavenie hĺbky fréz   | 8 mm                          |
| Prípojky pre odsávanie prachu | 27 mm                         |
| Hmotnosť                      | 2,7 kg                        |

obj.č. 98-574375



**Horná frézka OF 1400**

|                               |                               |
|-------------------------------|-------------------------------|
| Príkon                        | 1400 W                        |
| Voľnobežné otáčky             | 10000-22500 min <sup>-1</sup> |
| Priemer klieštiny             | 6-12,7 mm                     |
| Rýchle prestavenie hĺbky fréz | 70 mm                         |
| Jemné nastavenie hĺbky fréz   | 8 mm                          |
| Prípojky pre odsávanie prachu | 27/36 mm                      |
| Hmotnosť                      | 4,5 kg                        |

obj.č. 98-574341

**Horná frézka OF 2200**

|                               |                               |
|-------------------------------|-------------------------------|
| Príkon                        | 2200 W                        |
| Voľnobežné otáčky             | 10000-22000 min <sup>-1</sup> |
| Priemer klieštiny             | 6-12,7 mm                     |
| Rýchle prestavenie hĺbky fréz | 80 mm                         |
| Jemné nastavenie hĺbky fréz   | 20 mm                         |
| Priemer frézy                 | 89 mm                         |
| Prípojky pre odsávanie prachu | 36 (27) mm                    |
| Hmotnosť                      | 7,8 kg                        |

obj.č. 98-574392

**Ponorná píla TS 55 R**

|                               |                             |
|-------------------------------|-----------------------------|
| Príkon                        | 1200 W                      |
| Voľnobežné otáčky             | 2000-5200 min <sup>-1</sup> |
| Priemer pilového kotúča       | 160 mm                      |
| Šikmá poloha                  | -1 / +47 °                  |
| Hĺbka rezu                    | 0-55 mm                     |
| Hĺbka rezu pri 45°            | 0-43 mm                     |
| Hĺbka rezu pri 45°/90°        | 0-43/0-55 mm                |
| Prípojky pre odsávanie prachu | 27/36 mm                    |
| Hmotnosť                      | 4,5 kg                      |

obj.č. 98-561580



#### Rotačná leštička SHINEX RAP 150

|                       |                |
|-----------------------|----------------|
| Príkon                | 1200 W         |
| Voľnobežné otáčky     | 400-2100 min-1 |
| Leštiaci tanier max.  | 150 mm         |
| Upínací závit taniera | M14            |
| Hmotnosť              | 2,1 kg         |

obj.č. 98-570804



#### Kefovacia brúska RUSTOFIX RAS 180

|                               |                |
|-------------------------------|----------------|
| Príkon                        | 1500 W         |
| Voľnobežné otáčky             | 800-4000 min-1 |
| Kefovací nástroj o priemere   | 150 mm         |
| Upínací závit taniera         | M14            |
| Prípojky pre odsávanie prachu | 27 mm          |
| Hmotnosť                      | 7,5 kg         |

obj.č. 98-570775



#### PLANEX LHS 225 CT 36 Set

|                               |               |
|-------------------------------|---------------|
| Príkon                        | 550 W         |
| Počet otáčok                  | 340-910 min-1 |
| Priemer brúsneho kotúča       | 215 mm        |
| Prípojky pre odsávanie prachu | 36 mm         |
| Hmotnosť (dĺžka 1,60 m)       | 4,6 kg        |
| Hmotnosť (dĺžka 1,10 m)       | 3,8 kg        |

obj.č. 98-571849



| Objednávkové číslo       | č. strany | Objednávkové číslo | č. strany | Objednávkové číslo | č. strany | Objednávkové číslo | č. strany |
|--------------------------|-----------|--------------------|-----------|--------------------|-----------|--------------------|-----------|
| <b>Nábytkové kovanie</b> |           |                    |           |                    |           |                    |           |
| 56-3550                  | 5         | 56-0034            | 10        | 56-5413            | 18        | 56-1270            | 21        |
| 56-3650                  | 5         | 71-31190500        | 10        | 56-5103            | 18        | 56-0564            | 21        |
| 56-3750                  | 5         | 71-31190501        | 10        | 56-5520            | 18        | 56-0698            | 21        |
| 56-4282                  | 5         | 71-31190502        | 10        | 56-4512            | 18        | 56-0414            | 22        |
| 56-3580                  | 5         | 24-01119022        | 11        | 56-5013            | 18        | 56-0185            | 22        |
| 56-0652                  | 5         | 24-01119042        | 11        | 56-5513            | 18        | 56-7418            | 22        |
| 56-3590                  | 5         | 24-01119082        | 11        | 56-6512            | 18        | 56-8418            | 22        |
| 56-3690                  | 5         | 56-0333            | 11        | 56-5113            | 18        | 56-7468            | 22        |
| 56-3790                  | 5         | 56-0406            | 11        | 56-7400            | 19        | 56-8468            | 22        |
| 56-1934                  | 6         | 56-1333            | 11        | 56-8400            | 19        | 56-7518            | 22        |
| 56-0934                  | 6         | 56-0036            | 11        | 56-7450            | 19        | 56-8518            | 22        |
| 56-9658                  | 6         | 56-0377            | 11        | 56-8450            | 19        | 56-8568            | 22        |
| 56-9556                  | 6         | 56-0377*           | 11        | 56-7500            | 19        | 56-7618            | 22        |
| 56-0001                  | 7         | 71-31632600        | 11        | 56-8500            | 19        | 56-8618            | 22        |
| 56-0009                  | 7         | 71-31632601        | 11        | 56-7550            | 19        | 56-0700            | 22        |
| 56-0011                  | 7         | 71-31632601*       | 11        | 56-8550            | 19        | 71-55491519        | 22        |
| 56-0253                  | 7         | 56-0038            | 11        | 56-7271            | 19        | 56-8439            | 22        |
| 56-0437                  | 7         | 56-0038*           | 11        | 56-0687            | 19        | 56-7193            | 22        |
| 56-1437                  | 7         | 56-0038**          | 11        | 56-7311            | 19        | 56-9195            | 22        |
| 56-0533                  | 7         | 71-31634501        | 12        | 56-8301            | 19        | 56-0752            | 22        |
| 71-34281502              | 7         | 71-31634501        | 12        | 56-7351            | 19        | 56-0374            | 22        |
| 71-34281502*             | 7         | 71-31634501        | 12        | 56-8351            | 19        | 56-0042            | 22        |
| 56-0672                  | 8         | 56-0012            | 12        | 56-7401            | 19        | 56-3073            | 22        |
| 56-1672                  | 8         | 56-0173            | 12        | 56-8401            | 19        | 56-3074            | 22        |
| 56-1672*                 | 8         | 56-2533            | 12        | 56-7451            | 19        | 56-3212            | 22        |
| 56-0010*                 | 8         | 71-31633300        | 12        | 56-8451            | 19        | 56-8443            | 22        |
| 56-9950*                 | 8         | 71-31633301        | 12        | 56-7501            | 19        | 56-0368            | 22        |
| 56-0385*                 | 8         | 71-31633302        | 12        | 56-8501            | 19        | 56-7301            | 22        |
| 56-0169                  | 8         | 71-31610420        | 12        | 56-7551            | 19        | 56-8449            | 22        |
| 56-0182                  | 8         | 71-31610520        | 12        | 56-8551            | 19        | 56-8445            | 22        |
| 56-0236                  | 8         | 71-31610120        | 12        | 56-7601            | 19        | 56-8440            | 23        |
| 56-0147                  | 8         | 71-31610410        | 12        | 56-8601            | 19        | 56-7199            | 23        |
| 56-0172                  | 8         | 71-31610510        | 12        | 56-7651            | 19        | 56-7195            | 23        |
| 56-0269                  | 8         | 71-31610110        | 12        | 56-8651            | 19        | 56-8442            | 23        |
| 56-0222                  | 8         | 56-0035            | 13        | 56-8352            | 20        | 56-8441            | 23        |
| 56-0043                  | 8         | 56-0214            | 13        | 56-8411            | 20        | 56-2082            | 23        |
| 56-0159                  | 8         | 56-0031            | 13        | 56-7452            | 20        | 56-2084            | 23        |
| 56-0026                  | 8         | 56-0061            | 13        | 56-8452            | 20        | 56-2152            | 23        |
| 56-0299                  | 8         | 56-0022            | 13        | 56-7511            | 20        | 56-2154            | 23        |
| 56-0296                  | 8         | 56-0173            | 13        | 56-8511            | 20        | 56-0366            | 23        |
| 56-0238                  | 9         | 56-8728            | 13        | 56-8552            | 20        | 56-3029            | 23        |
| 56-0238*                 | 9         | 71-31198500        | 13        | 56-0680            | 20        | 56-3028            | 23        |
| 56-0237                  | 9         | 71-31651502        | 13        | 56-0592            | 20        | 56-8444            | 23        |
| 56-1237                  | 9         | 71-31651504        | 13        | 56-1592            | 20        | 56-2153            | 23        |
| 56-0200                  | 9         | 71-31651506        | 13        | 56-0162            | 20        | 56-2151            | 23        |
| 56-0607                  | 9         | 71-31651508        | 13        | 56-1162            | 20        | 56-7266            | 23        |
| 56-1607                  | 9         | 56-0692            | 13        | 56-7030            | 20        | 56-4799            | 23        |
| 56-0234                  | 9         | 56-9731            | 13        | 56-8030            | 20        | 56-9434            | 23        |
| 56-0263                  | 9         | 56-9730            | 13        | 56-7032            | 20        | 56-9082            | 23        |
| 56-0235                  | 9         | 56-9733            | 13        | 56-8032            | 20        | 56-9084            | 23        |
| 56-0530                  | 9         | 56-7680            | 14        | 56-0163            | 20        | 56-0163            | 23        |
| 56-0157                  | 9         | 56-9710            | 14        | 56-0210            | 20        | 56-0210            | 23        |
| 56-1563                  | 9         | 56-0701            | 14        | 56-7296            | 21        | 56-7976            | 23        |
| 56-1663                  | 9         | 56-9701            | 14        | 56-8296            | 21        | 56-7197            | 24        |
| 56-0534                  | 9         | 56-5002            | 14        | 56-7346            | 21        | 56-8493            | 24        |
| 56-3504                  | 9         | 56-1201            | 15        | 56-8346            | 21        | 56-8410            | 24        |
| 56-0002                  | 10        | 56-1501            | 15        | 56-7396            | 21        | 56-0049            | 24        |
| 56-0479                  | 10        | 56-0724            | 15        | 56-8396            | 21        | 56-3927            | 24        |
| 56-1348                  | 10        | 56-0723            | 15        | 56-7446            | 21        | 56-8272            | 24        |
| 56-0248                  | 10        | 56-0732*           | 15        | 56-8446            | 21        | 56-8478            | 24        |
| 56-0249                  | 10        | 56-0723            | 15        | 56-7496            | 21        | 56-0369            | 24        |
| 56-0016                  | 10        | 56-0725            | 15        | 56-8496            | 21        | 56-3033            | 24        |
| 56-0506                  | 10        | 56-0726            | 15        | 56-8546            | 21        | 56-3030            | 24        |
| 56-0229                  | 10        | 56-2711            | 18        | 56-7596            | 21        | 56-7978            | 24        |
| 56-0304                  | 10        | 56-3011            | 18        | 56-8596            | 21        | 56-7194            | 24        |
| 56-0266                  | 10        | 56-3511            | 18        | 56-0682            | 21        | 56-3034            | 24        |
| 56-0281                  | 10        | 56-4011            | 18        | 56-7010            | 21        | 56-7304            | 24        |
| 56-0267                  | 10        | 56-4503            | 18        | 56-7210            | 21        | 56-4272            | 24        |
| 56-0268                  | 10        | 56-5003            | 18        | 56-7310            | 21        | 56-4274            | 24        |
| 56-0306                  | 10        | 56-5521            | 18        | 56-7410            | 21        | 56-0689            | 24        |
| 56-0023                  | 10        | 56-3512            | 18        | 56-3270            | 21        | 56-0690            | 24        |
|                          |           | 56-4110            | 18        | 56-2270            | 21        | 56-5162            | 25        |

| Objednávkové číslo | č. strany | Objednávkové číslo | č. strany | Objednávkové číslo | č. strany | Objednávkové číslo | č. strany |
|--------------------|-----------|--------------------|-----------|--------------------|-----------|--------------------|-----------|
| 56-6162            | 25        | 56-0683            | 29        | 56-0693            | 32        | 24-02101450        | 35        |
| 56-9132            | 25        | 56-9068            | 29        | 56-2563            | 32        | 24-02101500        | 35        |
| 56-8132            | 25        | 56-0493            | 29        | 56-0696            | 32        | 24-02101550        | 35        |
| 56-7402            | 25        | 56-9411            | 29        | 56-0702            | 32        | 24-02101600        | 35        |
| 56-7597            | 25        | 56-3316            | 30        | 56-0699            | 32        | 24-04289350        | 35        |
| 56-7549            | 25        | 56-3736            | 30        | 56-5509            | 32        | 24-04289400        | 35        |
| 56-7206            | 25        | 56-5811            | 30        | 56-5588            | 32        | 24-04289450        | 35        |
| 56-7211            | 25        | 56-3118            | 30        | 56-0393            | 33        | 24-04289500        | 35        |
| 56-7109            | 25        | 56-4943            | 30        | 56-0355            | 33        | 20-02307004        | 35        |
| 56-7008            | 25        | 56-1929            | 30        | 56-0273            | 33        | 20-02308004        | 35        |
| 56-7009            | 25        | 56-6600            | 30        | 56-0164            | 33        | 62-8250            | 35        |
| 56-7552            | 25        | 56-9368            | 30        | 56-1164            | 33        | 62-8300            | 35        |
| 56-7205            | 25        | 56-1112            | 30        | 56-0152            | 33        | 62-8350            | 35        |
| 56-7201            | 25        | 56-1113            | 30        | 56-0448            | 33        | 62-8400            | 35        |
| 56-7282            | 25        | 56-1114            | 30        | 56-0389            | 33        | 24-04227450        | 35        |
| 56-7283            | 25        | 56-1115            | 30        | 56-0196            | 33        | 24-04227500        | 35        |
| 56-7554            | 25        | 56-1116            | 30        | 56-1196            | 33        | 62-8550            | 35        |
| 56-7467            | 25        | 56-1117            | 30        | 56-0107            | 33        | 62-8600            | 35        |
| 56-3711            | 26        | 56-1118            | 30        | 56-0202            | 33        | 62-8650            | 35        |
| 56-3016            | 26        | 56-1119            | 30        | 56-0106            | 33        | 62-8700            | 35        |
| 56-3513            | 26        | 56-1121            | 30        | 56-0203            | 33        | 56-2200            | 36        |
| 56-4012            | 26        | 56-1122            | 30        | 56-0067            | 33        | 56-2500            | 36        |
| 56-4513            | 26        | 56-6449            | 30        | 56-0204            | 33        | 56-2800            | 36        |
| 56-5213            | 26        | 56-6616            | 30        | 56-0072            | 33        | 56-3209            | 36        |
| 56-5514            | 26        | 56-0021            | 31        | 56-0439            | 33        | 56-3509            | 36        |
| 56-0633            | 26        | 56-0387            | 31        | 56-0108            | 33        | 56-3809            | 36        |
| 56-0636            | 26        | 56-0091            | 31        | 56-0205            | 33        | 56-3909            | 36        |
| 56-0645            | 26        | 56-0198            | 31        | 24-03101271        | 34        | 56-0229            | 36        |
| 56-0634            | 26        | 56-0092            | 31        | 24-03101301        | 34        | 56-5553            | 36        |
| 56-2904            | 26        | 56-0297            | 31        | 24-03101351        | 34        | 56-6553            | 36        |
| 56-0635            | 26        | 56-0093            | 31        | 24-03101401        | 34        | 56-5550            | 36        |
| 56-0638            | 26        | 56-0219            | 31        | 24-03101451        | 34        | 56-5551            | 36        |
| 56-0637            | 26        | 56-0218            | 31        | 24-03101501        | 34        | 56-0229            | 36        |
| 56-0643            | 26        | 56-1021            | 31        | 24-03101551        | 34        | 56-5500            | 36        |
| 56-0644            | 26        | 56-1387            | 31        | 56-0398            | 34        | 56-5552            | 36        |
| 56-0640            | 26        | 56-1091            | 31        | 56-0504            | 34        | 56-0229            | 36        |
| 56-1046            | 26        | 56-2198            | 31        | 56-0312            | 34        | 56-0694            | 36        |
| 56-0730            | 26        | 56-1092            | 31        | 56-0313            | 34        | 56-0729            | 36        |
| 56-0458            | 26        | 56-1297            | 31        | 56-0390            | 34        | 56-0728            | 36        |
| 56-0518            | 26        | 56-1093            | 31        | 56-0033            | 34        | 56-3302            | 37        |
| 56-0604            | 26        | 56-0619            | 31        | 56-1033            | 34        | 56-3301            | 37        |
| 56-0633            | 26        | 56-0089            | 31        | 56-0130            | 34        | 56-2401            | 37        |
| 56-0457            | 27        | 56-0276            | 31        | 56-1130            | 34        | 56-9016            | 37        |
| 56-0518            | 27        | 56-0211            | 31        | 24-03104450        | 34        | 56-3312            | 37        |
| 56-0605            | 27        | 56-0212            | 31        | 24-03104500        | 34        | 56-3303            | 37        |
| 56-0603            | 27        | 56-0160            | 31        | 56-0064            | 34        | 56-3304            | 37        |
| 56-0632            | 27        | 56-0209            | 31        | 56-1064            | 34        | 56-3305            | 37        |
| 56-0457            | 27        | 56-0424            | 31        | 56-0344            | 34        | 56-3505            | 37        |
| 56-0518            | 27        | 56-5464            | 31        | 56-1344            | 34        | 56-2011            | 37        |
| 56-0517            | 27        | 56-1619            | 31        | 56-0079            | 34        | 56-4200            | 37        |
| 56-0605            | 27        | 56-1089            | 31        | 56-1079            | 34        | 56-5204            | 37        |
| 56-0631            | 27        | 56-1276            | 31        | 56-0065            | 34        | 56-3205            | 37        |
| 56-0457            | 27        | 56-1211            | 31        | 56-0350            | 34        | 56-3206            | 37        |
| 56-0518            | 27        | 56-0706            | 31        | 56-0367            | 35        | 56-2021            | 37        |
| 56-0517            | 27        | 56-1212            | 31        | 56-1367*           | 35        | 56-2310            | 37        |
| 56-0605            | 27        | 56-1160            | 31        | 56-0255            | 35        | 56-2510            | 37        |
| 56-0631            | 27        | 56-1209            | 31        | 56-0047*           | 35        | 56-2027            | 37        |
| 56-0683            | 27        | 56-1424            | 31        | 56-0256            | 35        | 56-5029            | 37        |
| 56-0457            | 27        | 56-5463            | 31        | 56-0571*           | 35        | 56-3200            | 38        |
| 56-0518            | 27        | 56-1103            | 32        | 56-0257            | 35        | 56-3510            | 38        |
| 56-0517            | 27        | 56-2209            | 32        | 56-1257*           | 35        | 56-2038            | 38        |
| 56-0605            | 27        | 56-0703            | 32        | 56-0322            | 35        | 56-2039            | 38        |
| 56-0631            | 27        | 56-1213            | 32        | 56-0629*           | 35        | 56-4200            | 38        |
| 24-41101001        | 28        | 56-1218            | 32        | 24-03901300        | 35        | 56-5204            | 38        |
| 24-41109001        | 28        | 56-0691            | 32        | 24-03901400        | 35        | 56-2010            | 38        |
| 24-41110001        | 28        | 56-0543            | 32        | 24-03901450        | 35        | 56-3027            | 38        |
| 80-2122            | 28        | 56-0094            | 32        | 24-03901500        | 35        | 56-2300            | 38        |
| 24-41108001        | 28        | 56-1094            | 32        | 24-03901550        | 35        | 56-2511            | 38        |
| 80-2215            | 28        | 56-1572            | 32        | 24-02101250        | 35        | 56-2700            | 38        |
| 80-2216            | 28        | 56-0197            | 32        | 24-02101300        | 35        | 56-2900            | 38        |
| 56-0492            | 28        | 56-0363            | 32        | 24-02101350        | 35        | 56-4200            | 38        |
| 56-0678            | 28        | 56-0364            | 32        | 24-02101400        | 35        | 56-5204            | 38        |

| Objednávkové číslo | č. strany | Objednávkové číslo | č. strany | Objednávkové číslo | č. strany | Objednávkové číslo | č. strany |
|--------------------|-----------|--------------------|-----------|--------------------|-----------|--------------------|-----------|
| 56-7041            | 38        | 17-25210636        | 42        | 80-30201           | 48        | 71-63745906        | 53        |
| 56-7011            | 38        | 17-41210190        | 42        | 80-30200           | 48        | 24-22901001        | 53        |
| 56-2111            | 39        | 17-41210480        | 42        | 80-30014           | 48        | 17-23151031        | 53        |
| 56-2112            | 39        | 17-42210128        | 42        | 80-30015           | 48        | 17-23151531        | 53        |
| 56-2113            | 39        | 17-42210192        | 42        | 80-30017           | 48        | 17-23152031        | 53        |
| 56-2102            | 39        | 17-42210224        | 42        | 80-30019           | 48        | 62-5109            | 53        |
| 56-2103            | 39        | 17-42210320        | 42        | 80-30021           | 48        | 62-5159            | 53        |
| 56-4401            | 39        | 17-42210736        | 42        | 80-30022           | 48        | 62-5189            | 53        |
| 56-4402            | 39        | 17-43210160        | 42        | 80-30023           | 48        | 62-3925            | 53        |
| 56-4403            | 39        | 17-43210192        | 42        | 80-30879           | 48        | 62-1511            | 53        |
| 56-7441            | 39        | 17-43210224        | 42        | 80-30115           | 48        | 62-2018            | 54        |
| 56-7411            | 39        | 17-43210320        | 42        | 80-30276           | 48        | 62-2017            | 54        |
| 56-0719            | 39        | 17-43210480        | 42        | 80-30228           | 49        | 62-2019            | 54        |
| 56-1003            | 39        | 17-43210640        | 42        | 80-30229           | 49        | 62-2016            | 54        |
| 13-6248            | 39        | 17-44210128        | 42        | 80-30221           | 49        | 62-1925            | 54        |
| 13-6247            | 39        | 17-44210192        | 42        | 80-30187           | 49        | 62-0925            | 54        |
| 13-6405            | 39        | 17-44210224        | 42        | 80-30232           | 49        | 62-2020            | 54        |
| 13-6480            | 39        | 17-44210448        | 42        | 80-30234           | 49        | 71-66007304        | 54        |
| 13-6408            | 39        | 17-51290160        | 42        | 80-30236           | 49        | 71-66007301        | 54        |
| 13-6450            | 39        | 17-51290224        | 42        | 80-30238           | 49        | 71-66050333        | 54        |
| 71-37244612        | 39        | 17-51290320        | 42        | 80-30240           | 49        | 71-66007311        | 54        |
| 71-37244602        | 39        | 17-51290480        | 42        | 80-30242           | 49        | 71-66007321        | 54        |
| 71-37366611        | 39        | 17-63454631        | 42        | 80-30244           | 49        | 24-06101040        | 54        |
| 71-37366612        | 39        | 17-75031029        | 43        | 80-30246           | 49        | 24-06101050        | 54        |
| 17-01210160        | 40        | 17-75031030        | 43        | 80-30376           | 49        | 71-66008321        | 54        |
| 17-01210172        | 40        | 17-75031129        | 43        | 80-30377           | 49        | 71-66306920        | 54        |
| 17-01210192        | 40        | 17-75031130        | 43        | 80-30092           | 49        | 71-66316920        | 54        |
| 17-01210256        | 40        | 17-75041017        | 43        | 80-30052           | 50        | 80-20677           | 54        |
| 17-01210372        | 40        | 17-75041217        | 43        | 80-30055           | 50        | 62-2051            | 55        |
| 17-01210448        | 40        | 17-75060019        | 43        | 80-30385           | 50        | 62-2050            | 55        |
| 17-08247532        | 40        | 17-75060030        | 43        | 80-30387           | 50        | 02-282785          | 55        |
| 17-08455947        | 40        | 17-75060119        | 43        | 80-30080           | 50        | 02-276748          | 55        |
| 17-08456147        | 40        | 17-75060130        | 43        | 80-30078           | 50        | 02-283770          | 55        |
| 17-08456547        | 40        | 17-75070129        | 43        | 24-33112060        | 50        | 02-276708          | 55        |
| 17-08456747        | 40        | 17-75070130        | 43        | 24-33112062        | 50        | 02-269733          | 55        |
| 17-08577419        | 40        | 17-75090047        | 43        | 24-33112061        | 50        | 80-6930            | 55        |
| 17-08634429        | 40        | 17-75090147        | 43        | 80-30018           | 50        | 80-6845            | 55        |
| 17-08634546        | 40        | 17-75091047        | 44        | 80-30398           | 50        | 80-1083            | 55        |
| 17-08634646        | 40        | 17-75091147        | 44        | 80-30132           | 50        | 80-1084            | 55        |
| 17-08652541        | 40        | 17-75105017        | 44        | 80-30115           | 51        | 80-1085            | 55        |
| 17-08652542        | 40        | 17-75105117        | 44        | 80-30098           | 51        | 80-1096            | 55        |
| 17-08652546        | 40        | 17-75106019        | 44        | 80-30009           | 51        | 99-002200          | 56        |
| 17-08652519        | 40        | 17-75106030        | 44        | 80-30630           | 51        | 99-002230          | 56        |
| 17-08668258        | 40        | 17-75626029        | 44        | 80-30120           | 51        | 99-002231          | 56        |
| 17-08700619        | 41        | 17-75626030        | 44        | 80-30162           | 51        | 99-002500          | 56        |
| 17-08701547        | 41        | 17-75626129        | 44        | 80-30117           | 51        | 99-002520          | 56        |
| 17-08701848        | 41        | 17-75626130        | 44        | 80-30118           | 51        | 99-002521          | 56        |
| 17-08701947        | 41        | 17-75900017        | 45        | 80-30119           | 51        | 99-002522          | 56        |
| 17-08702148        | 41        | 17-85412102        | 45        | 80-30632           | 51        | 99-002531          | 56        |
| 17-08770031        | 41        | 17-85452301        | 45        | 80-20675           | 51        | 99-002532          | 56        |
| 17-08845046        | 41        | 17-85452303        | 45        | 80-30275           | 51        | 99-005100          | 57        |
| 17-08845047        | 41        | 17-85452308        | 45        | 80-30276           | 51        | 99-005120          | 57        |
| 17-08845143        | 41        | 17-85452908        | 45        | 80-60049           | 51        | 99-005121          | 57        |
| 17-08845146        | 41        | 17-85472101        | 45        | 80-60050           | 51        | 99-005122          | 57        |
| 17-08872546        | 41        | 17-85472111        | 45        | 80-60051           | 51        | 99-005130          | 57        |
| 17-08872646        | 41        | 17-85473103        | 45        | 80-30699           | 52        | 99-005131          | 57        |
| 17-08872746        | 41        | 80-30172           | 46        | 80-30643           | 52        | 99-005132          | 57        |
| 17-08872946        | 41        | 80-30173           | 46        | 80-30183           | 52        | 99-001600          | 58        |
| 17-08873346        | 41        | 80-30251           | 46        | 80-30209           | 52        | 99-001620          | 58        |
| 17-08874046        | 41        | 80-30252           | 46        | 80-30121           | 52        | 99-001630          | 58        |
| 17-08875046        | 41        | 80-30174           | 46        | 80-30208           | 52        | 99-002600          | 58        |
| 17-08875047        | 41        | 80-30220           | 46        | 80-30644           | 52        | 99-003120          | 58        |
| 17-08993019        | 41        | 80-30219           | 46        | 80-30180           | 52        | 99-003130          | 58        |
| 17-08993031        | 41        | 80-30145           | 47        | 80-30091           | 52        | 99-001620          | 58        |
| 17-08993543        | 41        | 80-30143           | 47        | 71-63745371        | 53        | 99-001630          | 58        |
| 17-25210128        | 42        | 80-30182           | 47        | 71-63745344        | 53        | 99-002000          | 59        |
| 17-25210184        | 42        | 80-30057           | 47        | 71-63745326        | 53        | 99-3115            | 59        |
| 17-25210262        | 42        | 80-30000           | 47        | 71-63745308        | 53        | 99-3116            | 59        |
| 17-25210334        | 42        | 80-30002           | 47        | 24-22101004        | 53        | 99-002052          | 59        |
| 17-25210384        | 42        | 80-30006           | 47        | 24-22101003        | 53        | 99-006502          | 59        |
| 17-25210484        | 42        | 80-30199           | 48        | 24-22101001        | 53        | 99-006503          | 59        |
| 17-25210511        | 42        | 80-30198           | 48        | 71-63719906        | 53        | 99-006551          | 59        |

| Objednávkové číslo | č. strany | Objednávkové číslo | č. strany | Objednávkové číslo | č. strany | Objednávkové číslo | č. strany |
|--------------------|-----------|--------------------|-----------|--------------------|-----------|--------------------|-----------|
| 99-006552          | 59        | 99-000492          | 65        | 71-54617230        | 76        | 62-1679            | 82        |
| 99-006556          | 59        | 99-000514          | 65        | 71-54617220        | 76        | 62-1669            | 83        |
| 99-003500          | 60        | 99-000100          | 65        | 71-54617266        | 76        | 71-23465600        | 83        |
| 99-004000          | 60        | 99-000513          | 65        | 71-54617966        | 76        | 71-21040600        | 83        |
| 99-007500          | 60        | 99-000512          | 65        | 20-10029410        | 76        | 71-23588600        | 83        |
| 99-3575            | 60        | 99-000510          | 65        | 20-10029420        | 76        | 71-21040600        | 83        |
| 99-0246            | 60        | 99-000509          | 65        | 20-00051201        | 76        | 62-1045            | 84        |
| 99-004054          | 60        | 99-000580          | 66        | 20-00051202        | 76        | 62-1060            | 84        |
| 99-006000          | 60        | 99-000581          | 66        | 71-54133245        | 76        | 62-1083            | 84        |
| 99-008000          | 60        | 99-000424          | 66        | 71-54133246        | 76        | 20-00006101        | 84        |
| 99-006120          | 60        | 99-000434          | 66        | 71-54133250        | 76        | 71-80520557        | 84        |
| 99-006130          | 60        | 99-000425          | 66        | 71-54133251        | 76        | 24-17102300        | 84        |
| 99-004054          | 60        | 99-000435          | 66        | 71-54133260        | 76        | 24-17102350        | 84        |
| 99-006200          | 61        | 99-000367          | 66        | 71-54133261        | 76        | 24-17102400        | 84        |
| 99-006300          | 61        | 99-000375          | 66        | 71-54133201        | 76        | 13-0194            | 84        |
| 99-006400          | 61        | 99-000368          | 66        | 20-05056001        | 77        | 13-0650            | 84        |
| 99-006120          | 61        | 99-000376          | 66        | 20-05001601        | 77        | 71-80720743        | 84        |
| 99-006130          | 61        | 99-000016          | 66        | 20-05053001        | 77        | 71-80721940        | 84        |
| 99-004130          | 61        | 99-000021          | 66        | 20-10050540        | 77        | 71-80725950        | 85        |
| 99-004150          | 61        | 99-000017          | 66        | 20-05025001        | 77        | 20-06215240        | 85        |
| 99-004100          | 61        | 99-000022          | 66        | 20-10050490        | 77        | 20-06215250        | 85        |
| 99-004200          | 61        | 99-000111          | 66        | 20-10050500        | 77        | 20-06215260        | 85        |
| 99-004300          | 61        | 99-000113          | 66        | 20-10050510        | 77        | 71-54494521        | 85        |
| 99-3575            | 61        | 99-000512          | 66        | 20-10050520        | 77        | 71-54494530        | 85        |
| 99-0246            | 61        | 99-000509          | 66        | 20-10050580        | 77        | 71-54494718        | 85        |
| 99-004130          | 61        | 99-000297          | 66        | 20-10050460        | 77        | 20-30000010        | 85        |
| 99-004150          | 61        | 99-000298          | 66        | 20-05062001        | 77        | 71-54443210        | 85        |
| 99-040100          | 62        | 99-000301          | 66        | 20-05008001        | 77        | 71-54443220        | 85        |
| 99-030050          | 62        | 99-000354          | 66        | 20-05007001        | 77        | 71-89214719        | 85        |
| 99-004130          | 62        | 99-000355          | 66        | 20-05045001        | 78        | 71-89214728        | 85        |
| 99-004150          | 62        | 99-000352          | 66        | 20-05044001        | 78        | 24-00010000        | 86        |
| 99-000293          | 64        | 99-000565          | 66        | 20-05065001        | 78        | 24-00001000        | 86        |
| 99-000294          | 64        | 99-000248          | 67        | 20-05011001        | 78        | 24-00002000        | 86        |
| 99-000284          | 64        | 99-000250          | 67        | 20-05073001        | 78        | 24-00002060        | 86        |
| 99-000282          | 64        | 99-000548325       | 68        | 20-05073001        | 78        | 24-00004000        | 86        |
| 99-000583          | 64        | 99-000538735       | 68        | 71-23226600        | 79        | 24-00004060        | 86        |
| 99-000582          | 64        | 99-000425616       | 70        | 71-23226610        | 79        | 24-00005000        | 86        |
| 99-000250          | 64        | 99-000328679       | 70        | 71-23226620        | 79        | 24-00005060        | 86        |
| 99-000248          | 64        | 99-000349413       | 70        | 71-21040600        | 79        | 71-83374050        | 86        |
| 99-000581          | 64        | 99-000146551       | 70        | 71-23227620        | 79        | 71-83374051        | 86        |
| 99-000580          | 64        | 99-00013687        | 70        | 71-23227520        | 79        | 71-83373340        | 86        |
| 99-000352          | 64        | 99-000297          | 70        | 71-232240720       | 79        | 71-83373400        | 86        |
| 99-000355          | 64        | 99-000298          | 70        | 24-09101130        | 79        | 71-83389044        | 86        |
| 99-000354          | 64        | 99-000169          | 70        | 71-23237991        | 79        | 71-83374718        | 86        |
| 99-000452          | 64        | 99-000171          | 70        | 62-4030            | 79        | 71-83374719        | 86        |
| 99-000444          | 64        | 99-000006          | 70        | 62-1902            | 79        | 71-83374901        | 86        |
| 99-000451          | 64        | 99-000276          | 71        | 62-1903            | 79        | 71-83373410        | 86        |
| 99-000392          | 64        | 20-10080320        | 74        | 71-22464650        | 80        | 71-83373420        | 86        |
| 99-000388          | 64        | 20-10080220        | 74        | 71-22607209        | 80        | 71-83373430        | 86        |
| 99-000391          | 64        | 20-10080260        | 74        | 71-21040600        | 80        | 71-83373330        | 86        |
| 99-000435          | 64        | 20-10080060        | 74        | 71-23230620        | 80        | 71-83373350        | 86        |
| 99-000425          | 64        | 20-10080070        | 74        | 71-21040600        | 80        | 71-83373360        | 86        |
| 99-000434          | 64        | 20-10080080        | 74        | 71-23776620        | 80        | 71-83389040        | 86        |
| 99-000424          | 64        | 20-10080130        | 74        | 71-23981930        | 80        | 71-83389043        | 86        |
| 99-000376          | 64        | 20-08033001        | 74        | 71-23968014        | 80        | 71-83374720        | 86        |
| 99-000368          | 64        | 20-10020010        | 75        | 71-23774920        | 80        | 71-83373000        | 87        |
| 99-000375          | 64        | 20-10029320        | 75        | 71-23960152        | 80        | 71-83373200        | 87        |
| 99-000376          | 64        | 71-54559266        | 75        | 71-21040600        | 80        | 71-83373210        | 87        |
| 99-000193          | 64        | 71-54559276        | 75        | 71-23342700        | 81        | 71-83374100        | 87        |
| 99-000195          | 64        | 71-54560208        | 75        | 71-23342710        | 81        | 71-83374110        | 87        |
| 99-000204          | 64        | 71-54560217        | 75        | 71-23342600        | 81        | 62-5005            | 87        |
| 99-000202          | 64        | 71-54560244        | 75        | 71-23342610        | 81        | 62-5006            | 87        |
| 99-000022          | 64        | 71-54560253        | 75        | 71-23342500        | 81        | 62-5009            | 87        |
| 99-000017          | 65        | 20-10021190        | 75        | 71-23342510        | 81        | 62-5012            | 87        |
| 99-000021          | 65        | 20-10021200        | 75        | 71-21040600        | 81        | 62-7049            | 87        |
| 99-000016          | 65        | 71-54252202        | 75        | 71-23340610        | 81        | 62-7069            | 87        |
| 99-000018          | 65        | 71-54252203        | 75        | 71-23340712        | 81        | 62-7099            | 87        |
| 99-000565          | 65        | 20-10029010        | 75        | 71-23340810        | 81        | 62-7012            | 87        |
| 99-000153          | 65        | 20-10021180        | 75        | 71-23344200        | 81        | 62-7104            | 87        |
| 99-000155          | 65        | 71-54253202        | 75        | 71-21040600        | 81        | 62-7106            | 87        |
| 99-000165          | 65        | 71-54253203        | 75        | 71-23499600        | 82        | 62-7109            | 87        |
| 99-000167          | 65        | 20-02070001        | 76        | 71-23747600        | 82        | 62-7112            | 87        |

| Objednávkové číslo | č. strany | Objednávkové číslo | č. strany | Objednávkové číslo | č. strany | Objednávkové číslo | č. strany |
|--------------------|-----------|--------------------|-----------|--------------------|-----------|--------------------|-----------|
| 71-83374901        | 87        | 44-50030           | 91        | 07-1076641         | 92        | 71-28332014        | 97        |
| 71-83374902        | 87        | 44-50035           | 91        | 07-1076642         | 92        | 71-28332023        | 97        |
| 71-83374903        | 87        | 44-50040           | 91        | 07-1076646         | 92        | 62-5100            | 97        |
| 71-27103510        | 88        | 44-50045           | 91        | 07-1076648         | 92        | 24-39105001        | 97        |
| 71-27103530        | 88        | 44-50050           | 91        | 07-1076650         | 92        | 24-39105010        | 97        |
| 71-27303510        | 88        | 44-50060           | 91        | 07-1076651         | 92        | 99-2169            | 97        |
| 71-27341540        | 88        | 44-50070           | 91        | 07-1076652         | 92        | 24-39105002        | 97        |
| 71-26051909        | 88        | 44-50080           | 91        | 07-1076653         | 92        | 24-39105020        | 97        |
| 71-26051196        | 88        | 44-50090           | 91        | 07-1076654         | 92        | 99-2170            | 97        |
| 71-26286003        | 89        | 44-50100           | 91        | 07-1076655         | 92        | 24-39105003        | 97        |
| 71-26286911        | 89        | 44-50110           | 91        | 07-1076656         | 92        | 24-39105030        | 97        |
| 71-26286912        | 89        | 44-50120           | 91        | 71-28243914        | 93        | 99-2171            | 97        |
| 71-26226073        | 89        | 44-60030           | 91        | 71-28243905        | 93        | 99-0172            | 97        |
| 71-26226074        | 89        | 44-60035           | 91        | 24-37117001        | 93        | 99-1172            | 97        |
| 71-26227029        | 89        | 44-60040           | 91        | 71-28206706        | 93        | 99-2172            | 97        |
| 71-26228026        | 89        | 44-60045           | 91        | 71-28206500        | 93        | 24-39105004        | 97        |
| 71-26224760        | 89        | 44-60050           | 91        | 71-28201701        | 93        | 24-39105040        | 97        |
| 71-26224064        | 89        | 44-60060           | 91        | 71-28140712        | 93        | 99-2173            | 97        |
| 71-26224162        | 89        | 44-60070           | 91        | 71-28141966        | 93        | 99-0174            | 97        |
| 71-26224564        | 89        | 44-60080           | 91        | 71-28220724        | 93        | 99-1174            | 97        |
| 71-26224368        | 89        | 44-60090           | 91        | 71-28224730        | 93        | 99-2174            | 97        |
| 71-26352203        | 89        | 44-60100           | 91        | 02-9250            | 94        | 24-39105005        | 97        |
| 71-26350203        | 89        | 44-60110           | 91        | 02-9340            | 94        | 24-39105050        | 97        |
| 71-26320981        | 89        | 44-60120           | 91        | 02-9360            | 94        | 99-2175            | 97        |
| 71-26324943        | 89        | 44-60130           | 91        | 02-9370            | 94        | 24-39105006        | 97        |
| 71-26359130        | 90        | 44-60140           | 91        | 02-9450            | 94        | 24-39105060        | 97        |
| 71-26359230        | 90        | 44-60150           | 91        | 02-9680            | 94        | 99-2176            | 97        |
| 71-26359330        | 90        | 44-60160           | 91        | 02-9770            | 95        | 24-39105007        | 97        |
| 71-26359430        | 90        | 44-60180           | 91        | 02-9690            | 95        | 24-39105070        | 97        |
| 71-26359730        | 90        | 44-60200           | 91        | 02-9950            | 95        | 99-2177            | 97        |
| 71-26296211        | 90        | 44-23516           | 92        | 02-773247-400      | 95        | 99-0178            | 97        |
| 71-26296220        | 90        | 44-23525           | 92        | 02-773247-300      | 95        | 99-1178            | 97        |
| 71-02234157        | 90        | 44-23530           | 92        | 02-773257-400      | 95        | 99-2178            | 97        |
| 71-26701715        | 90        | 44-23535           | 92        | 02-773257-300      | 95        | 99-0179            | 97        |
| 71-26701717        | 90        | 44-24016           | 92        | 02-70384-400       | 95        | 99-1179            | 97        |
| 71-26705703        | 90        | 44-24020           | 92        | 02-70384-300       | 95        | 99-2179            | 97        |
| 71-26705103        | 90        | 44-24030           | 92        | 02-773277-400      | 95        | 99-0166            | 97        |
| 71-02235305        | 90        | 44-24035           | 92        | 02-773277-300      | 95        | 99-0167            | 97        |
| 71-02235350        | 90        | 44-24040           | 92        | 02-779088-400      | 95        | 99-0168            | 97        |
| 71-02235403        | 90        | 44-24050           | 92        | 02-779088-300      | 95        | 20-10071106        | 98        |
| 71-02235458        | 90        | 44-14525           | 92        | 02-779098-400      | 95        | 20-10071126        | 98        |
| 71-02235501        | 90        | 44-14535           | 92        | 02-779098-300      | 95        | 20-07122602        | 98        |
| 71-03701022        | 90        | 07-1076594         | 92        | 62-7001            | 96        | 24-23105002        | 98        |
| 44-07050           | 90        | 07-1076595         | 92        | 62-7002            | 96        | 62-6270            | 98        |
| 44-07051           | 90        | 07-1076596         | 92        | 62-7003            | 96        | 62-2724            | 98        |
| 44-07052           | 90        | 07-1076597         | 92        | 62-7004            | 96        | 24-23105002        | 98        |
| 44-05050           | 90        | 07-1076603         | 92        | 62-7005            | 96        | 62-6270            | 98        |
| 44-35045           | 91        | 07-1076604         | 92        | 24-48104005        | 96        | 62-2724            | 98        |
| 44-35050           | 91        | 07-1076606         | 92        | 24-48104003        | 96        | 62-6221            | 98        |
| 44-40012           | 91        | 07-1076607         | 92        | 24-48104001        | 96        | 17-05095019        | 99        |
| 44-40016           | 91        | 07-1076608         | 92        | 24-48104003        | 96        | 17-05095027        | 99        |
| 44-40020           | 91        | 07-1076609         | 92        | 24-05509002        | 96        | 17-05095029        | 99        |
| 44-40025           | 91        | 07-1076614         | 92        | 24-05509013        | 96        | 17-05095030        | 99        |
| 44-40030           | 91        | 07-1076615         | 92        | 24-05509001        | 96        | 17-05095519        | 99        |
| 44-40035           | 91        | 07-1076616         | 92        | 71-26256708        | 96        | 17-05095523        | 99        |
| 44-40040           | 91        | 07-1076617         | 92        | 71-26256404        | 96        | 17-05095529        | 99        |
| 44-40045           | 91        | 07-1076618         | 92        | 71-26256155        | 96        | 17-05095531        | 99        |
| 44-40050           | 91        | 07-1076619         | 92        | 24-05510002        | 96        | 99-5767            | 99        |
| 44-40060           | 91        | 07-1076620         | 92        | 24-05509001        | 96        | 99-5769            | 99        |
| 44-40070           | 91        | 07-1076621         | 92        | 24-05510001        | 96        | 99-5776            | 99        |
| 44-45016           | 91        | 07-1076622         | 92        | 71-26255710        | 96        | 99-6477            | 99        |
| 44-45025           | 91        | 07-1076623         | 92        | 71-26255425        | 96        | 99-4944            | 99        |
| 44-45030           | 91        | 07-1076627         | 92        | 71-26255112        | 96        | 99-4945            | 99        |
| 44-45035           | 91        | 07-1076632         | 92        | 71-27000700        | 96        | 99-4946            | 99        |
| 44-45040           | 91        | 07-1076633         | 92        | 71-27000701        | 96        | 99-6223            | 99        |
| 44-45045           | 91        | 07-1076634         | 92        | 71-29008900        | 96        | 62-1200            | 100       |
| 44-45050           | 91        | 07-1076635         | 92        | 71-35621420        | 96        | 62-1041            | 100       |
| 44-45055           | 91        | 07-1076636         | 92        | 56-0438            | 96        | 62-4200            | 100       |
| 44-45060           | 91        | 07-1076637         | 92        | 17-24852005        | 96        | 62-3300            | 100       |
| 44-45070           | 91        | 07-1076638         | 92        | 17-24852019        | 96        | 99-2001            | 100       |
| 44-45080           | 91        | 07-1076639         | 92        | 17-24852105        | 96        | 99-2004            | 100       |
| 44-50025           | 91        | 07-1076640         | 92        | 17-24852119        | 96        | 99-2006            | 100       |

| Objednávkové číslo      | č. strany | Objednávkové číslo | č. strany | Objednávkové číslo | č. strany | Objednávkové číslo | č. strany |
|-------------------------|-----------|--------------------|-----------|--------------------|-----------|--------------------|-----------|
| 99-2002                 | 100       | 89-333239          | 122       | 89-112979          | 123       | 75-3477535         | 131       |
| 24-13102503             | 100       | 89-329139          | 122       | 89-800853          | 123       | 75-3483296         | 131       |
| 24-13105009             | 100       | 89-329439          | 122       | 89-843507          | 123       | 75-3276745         | 131       |
| 62-1506                 | 100       | 89-329160          | 122       | 89-843506          | 123       | 75-3333396         | 131       |
| 71-80333758             | 100       | 89-333229          | 122       | 89-719282          | 123       | 75-3319510         | 131       |
| 24-12102001             | 100       | 89-329177          | 122       | 89-719480          | 123       | 75-3331149         | 131       |
| 24-12114001             | 100       | 89-329207          | 122       | 89-719497          | 123       | 75-3473961         | 131       |
| 99-2007                 | 100       | 89-365113          | 122       | 89-711850          | 123       | 75-3345818         | 131       |
| 99-2008                 | 100       | 89-235271          | 122       | 75-3484655         | 128       | 75-3375459         | 131       |
| 99-2009                 | 100       | 89-329252          | 122       | 75-3484654         | 128       | 75-3483296         | 131       |
| 99-2010                 | 100       | 89-329146          | 122       | 75-3472482         | 128       | 75-3482334         | 131       |
| 99-2012                 | 100       | 89-329178          | 122       | 75-3484653         | 128       | 75-3482332         | 131       |
| 99-2013                 | 100       | 89-329221          | 122       | 75-3484650         | 128       | 75-3481400         | 131       |
| 99-2014                 | 100       | 89-329269          | 122       | 75-3484649         | 128       | 75-3481401         | 131       |
| 99-2015                 | 100       | 89-890729          | 123       | 75-3476858         | 128       | 75-3216471         | 131       |
| 71-80329317             | 100       | 89-890730          | 123       | 75-3473262         | 128       | 75-3355916         | 131       |
| 62-5750                 | 100       | 89-890738          | 123       | 75-3491441         | 128       | 75-3351110         | 131       |
| 62-5705                 | 100       | 89-890731          | 123       | 75-3458794         | 128       | 75-3351109         | 131       |
| 24-32102001             | 100       | 89-890732          | 123       | 75-3480125         | 128       | 75-3478724         | 131       |
| 80-30036                | 101       | 89-890733          | 123       | 75-3491444         | 128       | 75-3478725         | 131       |
| 80-30056                | 101       | 89-890570          | 123       | 75-3443770         | 128       | 75-3477658         | 131       |
| 80-30066                | 101       | 89-890737          | 123       | 75-3491439         | 128       | 75-3477657         | 131       |
| 80-30641                | 101       | 89-338438          | 123       | 75-3491440         | 128       | 75-3478552         | 132       |
| 80-30048                | 101       | 89-251120          | 123       | 75-3491293         | 128       | 75-3478553         | 132       |
| 80-20640                | 101       | 89-251121          | 123       | 75-3489073         | 128       | 75-3443327         | 132       |
| 80-30077                | 101       | 89-355555          | 123       | 75-3489073         | 128       | 75-3478302         | 132       |
| 80-30525                | 101       | 89-128343          | 123       | 75-3468659         | 128       | 75-3478303         | 132       |
| <b>Stavebné kovanie</b> |           | 89-128344          | 123       | 75-3482560         | 128       | 75-3478448         | 132       |
| 89-329061               | 122       | 89-903360          | 123       | 75-3483720         | 128       | 75-3478449         | 132       |
| 89-010001               | 122       | 89-326596          | 123       | 75-3483721         | 128       | 89-3478968         | 132       |
| 89-331163               | 122       | 89-326626          | 123       | 75-3491442         | 128       | 75-3478967         | 132       |
| 89-399244               | 122       | 89-903377          | 123       | 75-3482476         | 128       | 75-3483352         | 132       |
| 89-328347               | 122       | 89-904923          | 123       | 75-3482478         | 128       | 75-3483351         | 132       |
| 89-860649               | 122       | 89-329955          | 123       | 75-3482464         | 128       | 75-3449139         | 132       |
| 89-855555               | 122       | 89-399345          | 123       | 75-3482466         | 128       | 75-3449138         | 132       |
| 89-831922               | 122       | 89-329993          | 123       | 75-3482449         | 128       | 75-3468095         | 132       |
| 89-842973               | 122       | 89-904947          | 123       | 75-3202757         | 128       | 75-3468093         | 132       |
| 89-843017               | 122       | 89-010002          | 123       | 75-3115979         | 128       | 75-3449143         | 132       |
| 89-843055               | 122       | 89-010003          | 123       | 75-3466534         | 128       | 75-3449142         | 132       |
| 89-904367               | 122       | 89-324059          | 123       | 75-3454796         | 128       | 75-3449144         | 132       |
| 89-904381               | 122       | 89-324042          | 123       | 75-3454564         | 130       | 75-3449145         | 132       |
| 89-328446               | 122       | 89-324060          | 123       | 75-3453600         | 130       | 75-3449137         | 132       |
| 89-843093               | 122       | 89-313305          | 123       | 75-3470833         | 130       | 75-3449136         | 132       |
| 89-842974               | 122       | 89-235349          | 123       | 75-3386310         | 130       | 75-3457250         | 133       |
| 89-904383               | 122       | 89-313306          | 123       | 75-3328135         | 130       | 75-3466845         | 133       |
| 89-843079               | 122       | 89-300114          | 123       | 75-3308687         | 130       | 75-3468925         | 133       |
| 89-904385               | 122       | 89-239087          | 123       | 75-3388404         | 130       | 75-3338139         | 133       |
| 89-890720               | 122       | 89-239773          | 123       | 75-3386310         | 130       | 75-3200325         | 133       |
| 89-890735               | 122       | 89-238684          | 123       | 75-3377395         | 130       | 75-3466981         | 133       |
| 89-126134               | 122       | 89-719169          | 123       | 75-3377393         | 130       | 75-3993699         | 133       |
| 89-126172               | 122       | 89-719152          | 123       | 75-3386310         | 130       | 75-3465923         | 133       |
| 89-126257               | 122       | 89-843512          | 123       | 75-3406519         | 130       | 75-3976479         | 133       |
| 89-126127               | 122       | 89-843543          | 123       | 75-3406512         | 130       | 75-3485984         | 133       |
| 89-126165               | 122       | 89-843522          | 123       | 75-3406518         | 130       | 75-3482036         | 133       |
| 89-126240               | 122       | 89-891231          | 123       | 75-3386310         | 130       | 75-3465936         | 133       |
| 89-130865               | 122       | 89-891223          | 123       | 75-3458247         | 130       | 75-0000116         | 133       |
| 89-130889               | 122       | 89-904787          | 123       | 75-3458254         | 130       | 75-0000100         | 133       |
| 89-130902               | 122       | 89-904333          | 123       | 75-3381675         | 130       | 75-0000002         | 133       |
| 89-130926               | 122       | 89-904788          | 123       | 75-3381527         | 130       | 75-3482257         | 133       |
| 89-130940               | 122       | 89-904789          | 123       | 75-3308725         | 130       | 75-3482258         | 133       |
| 89-130988               | 122       | 89-904792          | 123       | 75-3378077         | 130       | 75-3318916         | 133       |
| 89-155202               | 122       | 89-904793          | 123       | 75-3470513         | 130       | 75-3297582         | 133       |
| 89-155226               | 122       | 89-099030          | 123       | 75-3477319         | 130       | 75-3254248         | 133       |
| 89-155240               | 122       | 89-127124          | 123       | 75-3484544         | 130       | 75-3228000         | 133       |
| 89-155264               | 122       | 89-127999          | 123       | 75-3481318         | 131       | 75-3128260         | 133       |
| 89-126813               | 122       | 89-113499          | 123       | 75-3481317         | 131       | 75-50808121        | 134       |
| 89-126837               | 122       | 89-112980          | 123       | 75-3477105         | 131       | 75-50808200        | 134       |
| 89-126820               | 122       | 89-112978          | 123       | 75-3477104         | 131       | 75-50808210        | 134       |
| 89-126844               | 122       | 89-909683          | 123       | 75-3478728         | 131       | 75-50808220        | 134       |
| 89-114350               | 122       | 89-112977          | 123       | 75-3329805         | 131       | 75-50808230        | 134       |
| 89-114450               | 122       | 89-801173          | 123       | 75-3329804         | 131       | 75-50808260        | 134       |
| 89-114670               | 122       | 89-119923          | 123       | 75-3221513         | 131       | 75-50808270        | 134       |

| Objednávkové číslo | č. strany | Objednávkové číslo | č. strany | Objednávkové číslo | č. strany | Objednávkové číslo | č. strany |
|--------------------|-----------|--------------------|-----------|--------------------|-----------|--------------------|-----------|
| 75-50808560        | 134       | 75-02257985        | 138       | 76-1343            | 143       | 76-0226            | 145       |
| 75-51006800        | 134       | 75-02306564        | 138       | 76-1347            | 143       | 76-0034            | 145       |
| 75-51006801        | 134       | 75-02257969        | 138       | 76-5041            | 143       | 76-0021            | 145       |
| 75-51006809        | 134       | 75-02726251        | 138       | 76-5043            | 143       | 76-0026            | 145       |
| 75-51006885        | 134       | 75-02726260        | 138       | 76-5047            | 143       | 76-0223            | 145       |
| 75-11398028        | 134       | 75-02726243        | 138       | 76-0201            | 143       | 76-0031            | 145       |
| 75-11398077        | 134       | 75-02726235        | 138       | 76-0174            | 143       | 76-0023            | 145       |
| 75-11399016        | 134       | 75-02602726        | 140       | 76-0175            | 143       | 76-0028            | 145       |
| 75-52510240        | 134       | 75-02273900        | 140       | 76-0074            | 143       | 76-0225            | 145       |
| 75-52510320        | 134       | 75-03667433        | 140       | 76-0077            | 143       | 76-0033            | 145       |
| 75-52510420        | 134       | 75-02273897        | 140       | 76-0075            | 143       | 76-0115            | 145       |
| 75-42050000        | 135       | 75-02602726        | 140       | 76-0078            | 143       | 76-0113            | 145       |
| 75-42090000        | 135       | 75-02322046        | 140       | 76-0076            | 143       | 76-0227            | 145       |
| 75-43090000        | 135       | 75-02137713        | 140       | 76-0079            | 143       | 76-0114            | 145       |
| 75-37058077        | 135       | 75-02137772        | 140       | 76-0140            | 144       | 76-0167            | 146       |
| 75-37069016        | 135       | 75-02085773        | 140       | 76-0067            | 144       | 76-0168            | 146       |
| 75-37091036        | 135       | 75-02137721        | 140       | 76-0144            | 144       | 76-0250            | 146       |
| 75-30303589        | 135       | 75-02137570        | 140       | 76-0069            | 144       | 76-0252            | 146       |
| 75-30303583        | 135       | 75-02137684        | 140       | 76-1090            | 144       | 76-0251            | 146       |
| 75-30303596        | 135       | 75-03672742        | 140       | 76-0143            | 144       | 76-0253            | 146       |
| 75-90110000        | 135       | 75-03670317        | 140       | 76-0068            | 144       | 76-0041            | 146       |
| 75-90191036        | 135       | 75-02877287        | 140       | 76-0145            | 144       | 76-0044            | 146       |
| 75-90510000        | 135       | 75-02877720        | 140       | 76-0070            | 144       | 76-0042            | 146       |
| 75-90591036        | 135       | 75-03672751        | 140       | 76-0277            | 144       | 76-0045            | 146       |
| 89-844052          | 136       | 75-03670341        | 140       | 76-0088            | 144       | 76-0043            | 146       |
| 89-849712          | 136       | 75-02089678        | 140       | 76-0238            | 144       | 76-0046            | 146       |
| 89-252314          | 136       | 75-02089660        | 140       | 76-0092            | 144       | 76-0180            | 146       |
| 89-869079          | 136       | 75-06958300        | 140       | 76-0089            | 144       | 76-0181            | 146       |
| 89-844069          | 136       | 75-06964480        | 140       | 76-0239            | 144       | 76-5541            | 146       |
| 89-875926          | 136       | 75-00654796        | 140       | 76-0093            | 144       | 76-5543            | 146       |
| 89-875940          | 136       | 75-00840182        | 140       | 76-0090            | 144       | 76-5547            | 146       |
| 89-875902          | 136       | 75-03670384        | 141       | 76-0240            | 144       | 76-5053            | 146       |
| 89-884744          | 136       | 75-03670368        | 141       | 76-0084            | 144       | 76-2411            | 146       |
| 89-895689          | 136       | 75-03244271        | 141       | 76-0228            | 144       | 76-2431            | 146       |
| 89-296325          | 136       | 75-03670325        | 141       | 76-0104            | 144       | 76-2432            | 146       |
| 89-296271          | 136       | 75-03670376        | 141       | 76-0086            | 144       | 76-5410            | 147       |
| 89-296349          | 136       | 75-03670350        | 141       | 76-0230            | 144       | 76-5430            | 147       |
| 89-296295          | 136       | 75-02698561        | 141       | 76-0105            | 144       | 76-5470            | 147       |
| 89-296301          | 136       | 75-02698465        | 141       | 76-0149            | 144       | 76-5441            | 147       |
| 89-296257          | 136       | 75-02741988        | 141       | 76-0232            | 144       | 76-5443            | 147       |
| 89-297803          | 136       | 75-02421634        | 141       | 76-0111            | 144       | 76-5447            | 147       |
| 89-297797          | 136       | 75-02419761        | 141       | 76-0129            | 144       | 76-0211            | 147       |
| 89-296333          | 136       | 75-02421482        | 141       | 76-0128            | 144       | 76-0212            | 147       |
| 89-296323          | 136       | 75-02741030        | 141       | 76-0234            | 144       | 75-02791352        | 147       |
| 89-329474          | 136       | 75-02740934        | 141       | 76-0235            | 144       | 75-02791281        | 147       |
| 89-151203          | 136       | 75-02740942        | 141       | 76-0125            | 144       | 75-02791256        | 147       |
| 89-524011          | 136       | 75-02421651        | 141       | 76-0124            | 144       | 75-02820416        | 147       |
| 89-530011          | 136       | 75-06990949        | 141       | 76-0085            | 145       | 75-02820424        | 147       |
| 89-151201          | 136       | 75-02202378        | 141       | 76-0229            | 145       | 75-0820467         | 147       |
| 89-151204          | 136       | 75-08002917        | 141       | 76-0100            | 145       | 75-02820061        | 148       |
| 89-151202          | 136       | 75-02089791        | 141       | 76-0087            | 145       | 75-02820096        | 148       |
| 89-329210          | 136       | 75-02421511        | 141       | 76-0231            | 145       | 75-0820117         | 148       |
| 89-530010          | 136       | 75-02896867        | 141       | 76-0101            | 145       | 75-02071611        | 148       |
| 89-329573          | 136       | 75-08165144        | 141       | 76-0148            | 145       | 75-02071689        | 148       |
| 89-534010          | 136       | 75-02345678        | 141       | 76-0233            | 145       | 75-02573064        | 149       |
| 89-512011          | 136       | 75-07167588        | 141       | 76-0102            | 145       | 75-02573048        | 149       |
| 89-333067          | 136       | 75-04528745        | 141       | 76-0127            | 145       | 75-0573451         | 149       |
| 75-01759393        | 138       | 75-04220228        | 141       | 76-0126            | 145       | 75-02573371        | 149       |
| 75-01925953        | 138       | 75-00823277        | 141       | 76-0236            | 145       | 75-02574201        | 149       |
| 75-01925961        | 138       | 24-90000002        | 142       | 76-0237            | 145       | 75-02574534        | 149       |
| 89-600001          | 138       | 24-91000002        | 142       | 76-0123            | 145       | 75-623082          | 149       |
| 89-600002          | 138       | 24-92000002        | 142       | 76-0122            | 145       | 75-623075          | 149       |
| 89-813744          | 138       | 24-90000013        | 142       | 76-0020            | 145       | 75-2574913         | 149       |
| 89-812739          | 138       | 24-91000013        | 142       | 76-0025            | 145       | 75-2574964         | 149       |
| 75-02245765        | 138       | 24-92000013        | 142       | 76-0219            | 145       | 75-2574921         | 149       |
| 75-02296431        | 138       | 24-90000009        | 142       | 76-0030            | 145       | 75-2574981         | 149       |
| 75-02245749        | 138       | 24-90000009        | 142       | 76-0022            | 145       | 75-2574956         | 149       |
| 75-02245757        | 138       | 24-90000009        | 142       | 76-0027            | 145       | 75-2574972         | 149       |
| 75-02471463        | 138       | 76-0004            | 143       | 76-0224            | 145       | 75-2574948         | 149       |
| 75-02471447        | 138       | 76-0005            | 143       | 76-0032            | 145       | 75-591732          | 149       |
| 75-03288880        | 138       | 76-0006            | 143       | 76-0024            | 145       | 75-766260          | 149       |
| 75-02257977        | 138       | 76-1341            | 143       | 76-0029            | 145       | 75-2602291         | 149       |



| Objednávkové číslo | č. strany | Objednávkové číslo | č. strany | Objednávkové číslo | č. strany | Objednávkové číslo | č. strany |
|--------------------|-----------|--------------------|-----------|--------------------|-----------|--------------------|-----------|
| 81-11679976        | 150       | 81-11604203        | 154       | 75-50100612        | 157       | 99-004150          | 165       |
| 81-11691322        | 150       | 81-11612381        | 154       | 75-00000020        | 157       | 99-040100          | 165       |
| 81-11691326        | 150       | 81-11642202        | 154       | 75-00003400        | 157       | 99-030030          | 165       |
| 81-11623129        | 150       | 81-00000831        | 154       | 75-00400001        | 157       | 99-030050          | 165       |
| 81-11634356        | 150       | 81-11234206        | 154       | 75-00500001        | 157       | 99-004130          | 165       |
| 81-11703451        | 150       | 81-11234192        | 154       | 75-00003633        | 157       | 99-004150          | 165       |
| 81-11703452        | 150       | 81-11673930        | 154       | 75-00003604        | 157       | 99-050100          | 165       |
| 81-11711030        | 150       | 81-11711046        | 154       | 75-00003612        | 157       | 99-100169          | 165       |
| 24-90005090        | 150       | 81-11691185        | 154       | 75-00030002        | 157       | 99-050171          | 165       |
| 24-90005091        | 150       | 81-11691854        | 154       | 75-00040002        | 157       | 99-100170          | 165       |
| 19-4091            | 150       | 81-11059056        | 154       | 75-00040002        | 157       | 99-100171          | 165       |
| 19-4025            | 150       | 81-11691186        | 154       | 75-51409740        | 157       | 99-100050          | 165       |
| 19-4090            | 150       | 81-11689877        | 154       | 99-003500          | 159       | 99-100150          | 165       |
| 19-4141            | 150       | 81-11603774        | 154       | 99-004000          | 159       | 99-100100          | 166       |
| 19-4088            | 150       | 75-00011701        | 155       | 99-3575            | 159       | 99-100169          | 166       |
| 19-4040            | 150       | 75-00011702        | 155       | 99-0246            | 159       | 99-100170          | 166       |
| 19-4048            | 150       | 75-00111701        | 155       | 99-003554          | 159       | 99-100171          | 166       |
| 19-4153            | 150       | 75-00111702        | 155       | 99-006500          | 159       | 99-100050          | 166       |
| 75-3105006         | 151       | 75-00011703        | 155       | 99-007500          | 159       | 99-100150          | 166       |
| 75-3104964         | 151       | 75-52507100        | 155       | 99-004600          | 159       | 54-101887          | 166       |
| 75-3105058         | 151       | 75-54005860        | 155       | 99-007600          | 159       | 54-102127          | 166       |
| 81-11644376        | 151       | 75-54004220        | 155       | 99-004620          | 159       | 54-102421          | 166       |
| 81-11611331        | 151       | 75-54015840        | 155       | 99-004600          | 160       | 54-102422          | 166       |
| 81-11611614        | 151       | 75-54006040        | 155       | 99-007600          | 160       | 54-102423          | 166       |
| 81-11613021        | 151       | 75-54006210        | 155       | 99-004620          | 160       | 54-102445          | 166       |
| 81-11260053        | 151       | 75-54004090        | 155       | 99-004503          | 160       | 54-102446          | 166       |
| 81-11632735        | 151       | 75-52509300        | 155       | 99-006600          | 160       | 54-102447          | 166       |
| 81-11632737        | 151       | 75-52506916        | 155       | 99-008600          | 160       | 54-102454          | 166       |
| 81-11630422        | 151       | 75-52506926        | 155       | 99-006621          | 160       | 54-102455          | 166       |
| 81-11630423        | 151       | 75-52506935        | 155       | 99-006631          | 160       | 54-102456          | 166       |
| 81-11664024        | 151       | 75-52506945        | 155       | 99-006651          | 160       | 54-102789          | 166       |
| 81-11664025        | 151       | 75-00000010        | 155       | 99-006320          | 160       | 54-102790          | 166       |
| 81-11659559        | 151       | 75-00000005        | 155       | 99-006330          | 160       | 54-102791          | 166       |
| 81-11659562        | 151       | 75-00000007        | 155       | 99-006420          | 160       | 54-102862          | 166       |
| 81-11612718        | 151       | 75-702012          | 156       | 99-006430          | 160       | 54-103086          | 166       |
| 75-3116173         | 152       | 75-706702          | 156       | 99-006450          | 160       | 54-131787          | 167       |
| 75-3116220         | 152       | 75-021345          | 156       | 99-011600          | 160       | 54-128294          | 167       |
| 19-5242            | 152       | 75-706656          | 156       | 99-012600          | 160       | 54-006666          | 167       |
| 19-5243            | 152       | 75-706705          | 156       | 99-012621          | 160       | 54-129272          | 167       |
| 19-5245            | 152       | 75-021371          | 156       | 99-012631          | 160       | 54-007432          | 167       |
| 19-5244            | 152       | 75-298642          | 156       | 99-012651          | 160       | 54-129277          | 167       |
| 81-11612718        | 152       | 75-923201          | 156       | 99-010320          | 160       | 54-008481          | 167       |
| 81-11630424        | 152       | 75-923199          | 156       | 99-010330          | 160       | 54-126966          | 167       |
| 89-699001          | 152       | 75-700587          | 156       | 99-010420          | 160       | 54-008483          | 167       |
| 75-3465936         | 152       | 75-021713          | 156       | 99-010430          | 160       | 54-129141          | 167       |
| 99-0042            | 152       | 75-929988          | 156       | 99-010450          | 160       | 54-008507          | 167       |
| 99-1042            | 152       | 75-929982          | 156       | 99-006000          | 161       | 54-120417          | 167       |
| 99-0043            | 152       | 75-929988          | 156       | 99-008000          | 161       | 54-126869          | 167       |
| 99-1043            | 152       | 75-706703          | 156       | 99-006120          | 161       | 54-129033          | 167       |
| 99-0186            | 152       | 75-929979          | 156       | 99-006130          | 161       | 54-129874          | 167       |
| 99-1186            | 152       | 75-929976          | 156       | 99-003554          | 161       | 54-129222          | 167       |
| 81-11670001        | 153       | 75-936079          | 156       | 99-006056          | 161       | 54-128874          | 167       |
| 81-11670007        | 153       | 75-944245          | 156       | 99-005600          | 161       | 54-016592          | 167       |
| 81-11670002        | 153       | 75-972181          | 156       | 99-006600          | 161       | 54-020015          | 167       |
| 81-11670003        | 153       | 99-1028            | 156       | 99-008600          | 161       | 54-020835          | 167       |
| 81-11670004        | 153       | 99-0028            | 156       | 99-006620          | 161       | 54-020836          | 167       |
| 81-11670005        | 153       | 99-1029            | 156       | 99-006301          | 161       | 54-020838          | 167       |
| 81-11670008        | 153       | 99-0029            | 156       | 99-006320          | 161       | 54-020839          | 167       |
| 81-11670006        | 153       | 99-1130            | 156       | 99-006430          | 161       | 54-022718          | 167       |
| 81-11670010        | 153       | 99-0030            | 156       | 99-006431          | 161       | 54-022720          | 167       |
| 81-11670009        | 153       | 99-1031            | 156       | 99-006302          | 161       | 54-022933          | 167       |
| 81-11711799        | 153       | 99-0031            | 156       | 99-012100          | 162       | 54-026291          | 167       |
| 81-11704105        | 153       | 99-0032            | 156       | 99-012020          | 162       | 54-026293          | 167       |
| 81-11704799        | 153       | 16-0192            | 157       | 99-012000          | 162       | 54-026654          | 167       |
| 81-11691687        | 153       | 16-0167            | 157       | 99-010112          | 164       | 54-026882          | 167       |
| 81-11711800        | 153       | 16-0166            | 157       | 99-010113          | 164       | 54-027333          | 167       |
| 81-11708775        | 153       | 16-9684            | 157       | 99-010114          | 164       | 54-027335          | 167       |
| 81-11702515        | 153       | 16-0796            | 157       | 99-010115          | 164       | 54-027558          | 167       |
| 81-11691684        | 153       | 16-0792            | 157       | 99-020100          | 165       | 54-027559          | 167       |
| 81-11691682        | 153       | 16-0794            | 157       | 99-030030          | 165       | 54-027561          | 167       |
| 81-11691678        | 153       | 16-1168            | 157       | 99-030050          | 165       | 54-028348          | 167       |
| 81-11691665        | 153       | 75-50100611        | 157       | 99-004130          | 165       | 54-028350          | 167       |

| Objednávkové číslo | č. strany | Objednávkové číslo | č. strany | Objednávkové číslo | č. strany | Objednávkové číslo | č. strany |
|--------------------|-----------|--------------------|-----------|--------------------|-----------|--------------------|-----------|
| 81-11770680        | 168       | 54-030971          | 171       | 05-451341          | 178       | 89-30540500        | 183       |
| 81-11880680        | 168       | 54-071924          | 171       | 05-450341          | 178       | 89-30545500        | 183       |
| 81-11770702        | 168       | 54-101792          | 171       | 05-731634          | 178       | 89-30542500        | 183       |
| 81-11880702        | 168       | 54-101793          | 171       | 05-731689          | 178       | 89-30971300        | 183       |
| 54-118476          | 169       | 54-030809          | 171       | 05-731641          | 178       | 89-30978300        | 183       |
| 54-119510          | 169       | 54-070546          | 171       | 05-861461          | 178       | 89-30970300        | 183       |
| 54-120021          | 169       | 54-056951          | 171       | 05-832577          | 178       | 89-30975300        | 183       |
| 54-122940          | 169       | 54-071354          | 171       | 05-734499          | 179       | 89-30972300        | 183       |
| 54-123511          | 169       | 54-101767          | 171       | 05-734475          | 179       | 89-30973300        | 183       |
| 54-123512          | 169       | 54-101794          | 171       | 05-734468          | 179       | 89-31091200        | 183       |
| 54-120135          | 169       | 54-101817          | 171       | 05-734482          | 179       | 89-31098200        | 183       |
| 54-120150          | 169       | 54-101878          | 171       | 05-132066          | 179       | 89-31090200        | 183       |
| 54-120161          | 169       | 54-074428          | 171       | 05-132127          | 179       | 89-31095200        | 183       |
| 54-123513          | 169       | 54-084955          | 171       | 05-132103          | 179       | 89-31093200        | 183       |
| 54-123514          | 169       | 54-095137          | 171       | 05-734635          | 179       | 89-30911200        | 184       |
| 54-124640          | 169       | 54-099245          | 171       | 05-734611          | 179       | 89-30918200        | 184       |
| 54-120287          | 169       | 54-099728          | 171       | 05-733263          | 179       | 89-30910200        | 184       |
| 54-120417          | 169       | 54-101765          | 171       | 05-734628          | 179       | 89-30915200        | 184       |
| 54-120432          | 169       | 54-101815          | 171       | 05-147237          | 179       | 89-70003350        | 184       |
| 54-120164          | 169       | 54-101816          | 171       | 05-147299          | 179       | 89-70002350        | 184       |
| 54-120165          | 169       | 54-063262          | 171       | 05-147282          | 179       | 89-91851100        | 184       |
| 54-120167          | 169       | 54-068221          | 171       | 05-734703          | 179       | 89-91852100        | 184       |
| 54-103388          | 169       | 54-068627          | 171       | 05-734680          | 179       | 89-91850100        | 184       |
| 54-103387          | 169       | 54-069272          | 171       | 05-557343          | 179       | 89-91855100        | 184       |
| 54-103386          | 169       | 54-043546          | 171       | 05-556442          | 179       | 89-31621025        | 184       |
| 54-103394          | 169       | 54-048941          | 171       | 05-859987          | 179       | 89-31622025        | 184       |
| 54-103393          | 169       | 54-053262          | 171       | 05-859680          | 179       | 89-31620025        | 184       |
| 54-103392          | 169       | 54-054560          | 171       | 05-958413          | 180       | 89-31625025        | 184       |
| 54-131211          | 170       | 54-055778          | 171       | 05-900487          | 180       | 89-00000001        | 184       |
| 54-131215          | 170       | 54-055778          | 171       | 05-130741          | 180       | 89-00000003        | 184       |
| 54-131449          | 170       | 54-069274          | 171       | 05-130758          | 180       | 89-00000002        | 184       |
| 54-102423          | 170       | 54-069780          | 171       | 05-043737          | 180       | 89-00000004        | 184       |
| 54-102422          | 170       | 54-029722          | 171       | 05-812166          | 180       | 89-31001300        | 185       |
| 54-102421          | 170       | 54-030373          | 171       | 05-488660          | 180       | 89-31008300        | 185       |
| 54-102456          | 170       | 54-030374          | 171       | 05-118626          | 180       | 89-31000300        | 185       |
| 54-102455          | 170       | 54-030376          | 171       | 05-838043          | 180       | 89-31005300        | 185       |
| 54-102454          | 170       | 54-030377          | 171       | 05-900597          | 180       | 89-31003300        | 185       |
| 54-102447          | 170       | 54-103386          | 171       | 05-557494          | 181       | 89-30782600        | 185       |
| 54-102446          | 170       | 05-811268          | 177       | 05-043676          | 181       | 89-30783600        | 185       |
| 54-102445          | 170       | 05-811183          | 177       | 05-200001          | 181       | 86-0240            | 186       |
| 54-055756          | 170       | 05-811138          | 177       | 05-210001          | 181       | 86-0241            | 186       |
| 54-128660          | 170       | 05-811220          | 177       | 05-902997          | 181       | 86-0007            | 186       |
| 54-128662          | 170       | 05-355024          | 177       | 05-886570          | 181       | 86-0245            | 186       |
| 54-135498          | 170       | 05-155024          | 177       | 05-755159          | 181       | 86-0242            | 186       |
| 54-136585          | 170       | 05-555024          | 177       | 05-918271          | 181       | 86-0165            | 186       |
| 54-132872          | 170       | 05-951032          | 177       | 05-118626          | 181       | 86-3063            | 186       |
| 54-135475          | 170       | 05-951131          | 177       | 05-118541          | 181       | 86-8004            | 186       |
| 54-132229          | 170       | 05-951070          | 177       | 05-832171          | 181       | 86-8011            | 186       |
| 54-103393          | 170       | 05-850045          | 177       | 05-832195          | 181       | 86-3601            | 186       |
| 54-128210          | 170       | 05-849964          | 177       | 05-832218          | 181       | 86-3602            | 186       |
| 54-103387          | 170       | 05-849926          | 177       | 05-832232          | 181       | 86-3211            | 186       |
| 54-103392          | 170       | 05-842736          | 177       | 05-832256          | 181       | 86-3212            | 186       |
| 54-103388          | 170       | 05-842811          | 177       | 89-30531400        | 183       | 86-3220            | 186       |
| 54-137178          | 170       | 05-842774          | 177       | 89-30538400        | 183       | 86-3221            | 186       |
| 54-138015          | 170       | 05-129790          | 177       | 89-30530400        | 183       | 86-1063            | 186       |
| 54-139384          | 170       | 05-129615          | 177       | 89-30535400        | 183       | 86-1062            | 186       |
| 54-141717          | 170       | 05-129592          | 177       | 89-30531240        | 183       | 86-0062            | 186       |
| 54-115549          | 171       | 05-107958          | 177       | 89-30532400        | 183       | 86-0065            | 186       |
| 54-111458          | 171       | 05-107996          | 177       | 89-30533400        | 183       | 86-0064            | 186       |
| 54-111459          | 171       | 05-107972          | 177       | 89-30531800        | 183       | 86-0657            | 186       |
| 54-111460          | 171       | 05-491705          | 178       | 89-30538800        | 183       | 86-4022            | 187       |
| 54-115385          | 171       | 05-491688          | 178       | 89-30530800        | 183       | 86-4023            | 187       |
| 54-030523          | 171       | 05-491644          | 178       | 89-30535800        | 183       | 86-0320            | 187       |
| 54-030611          | 171       | 05-491682          | 178       | 89-30701800        | 183       | 86-0452            | 187       |
| 54-030612          | 171       | 05-402411          | 178       | 89-30708800        | 183       | 86-0302            | 187       |
| 54-030614          | 171       | 05-402412          | 178       | 89-30700800        | 183       | 86-0500            | 187       |
| 54-030615          | 171       | 05-495017          | 178       | 89-30705800        | 183       | 86-0280            | 187       |
| 54-030797          | 171       | 05-494942          | 178       | 89-30701280        | 183       | 86-0302            | 187       |
| 54-030811          | 171       | 05-494904          | 178       | 89-30702800        | 183       | 86-9059            | 187       |
| 54-030861          | 171       | 05-755951          | 178       | 89-30703800        | 183       | 86-0520            | 187       |
| 54-030862          | 171       | 05-755913          | 178       | 89-30541500        | 183       | 86-0698            | 187       |
| 54-055756          | 171       | 05-755890          | 178       | 89-30548500        | 183       | 86-7918            | 188       |

| Objednávkové číslo    | č. strany | Objednávkové číslo | č. strany | Objednávkové číslo | č. strany | Objednávkové číslo | č. strany |
|-----------------------|-----------|--------------------|-----------|--------------------|-----------|--------------------|-----------|
| 86-7919               | 188       | 47-048060          | 201       | 57-2730            | 208       | 98-561580          | 232       |
| 86-7911               | 188       | 47-048070          | 201       | 57-0835            | 208       | 98-570804          | 233       |
| 86-7912               | 188       | 47-009810          | 202       | 57-1749            | 209       | 98-570775          | 233       |
| 86-8658               | 188       | 47-884608          | 202       | 57-0740            | 209       | 98-571849          | 233       |
| 18-2501               | 188       | 47-012605          | 202       | 57-6102            | 210       |                    |           |
| 18-2501               | 188       | 47-012606          | 202       | 57-3710            | 210       |                    |           |
| 18-2503               | 188       | 47-012609          | 202       | 57-2040            | 210       |                    |           |
| 18-2505               | 188       | 47-885110          | 202       | 57-3075            | 211       |                    |           |
| 18-2510               | 188       | 47-881540          | 202       | 57-0088            | 211       |                    |           |
| 18-2513               | 188       | 47-715505          | 202       | 57-1089            | 211       |                    |           |
| 18-2509               | 188       | 47-881521          | 202       | 57-2172            | 212       |                    |           |
| 18-2516               | 188       | 47-881523          | 202       | 57-7014            | 212       |                    |           |
| 18-2525               | 188       | 47-881526          | 202       | 57-1024            | 212       |                    |           |
| 18-2526               | 188       | 47-8815002         | 202       | 57-5013            | 213       |                    |           |
| 18-2504               | 188       | 47-8815003         | 202       | 57-5123            | 213       |                    |           |
| 18-2508               | 188       | 47-8815004         | 202       | 57-5323            | 213       |                    |           |
| 18-2513               | 188       | 47-8815005         | 202       | 57-5601            | 214       |                    |           |
| 18-2512               | 188       | 47-8815025         | 202       | 57-3620            | 214       |                    |           |
| 18-2524               | 188       | 47-8815027         | 202       | 57-3650            | 214       |                    |           |
| 18-2517               | 188       | 47-003425          | 203       | 57-0331            | 215       |                    |           |
| <b>Elektronáradie</b> |           | 40-3145            | 203       | 57-0341            | 215       |                    |           |
| 47-8896111            | 194       | 40-3146            | 203       | 57-0393            | 215       |                    |           |
| 47-8896112            | 194       | 40-3147            | 203       | 57-8132            | 216       |                    |           |
| 47-889005             | 194       | 47-012200          | 203       | 57-8490            | 216       |                    |           |
| 47-8892005            | 195       | 47-012300          | 203       | 57-0433            | 216       |                    |           |
| 47-8893302            | 195       | 47-012500          | 203       | 57-6453            | 216       |                    |           |
| 47-8893401            | 195       | 47-003327          | 203       | 57-2641            | 217       |                    |           |
| 47-8894202            | 195       | 47-018799          | 203       | 57-0682            | 217       |                    |           |
| 47-8894305            | 195       | 47-103574          | 203       | 57-0621            | 217       |                    |           |
| 47-8897210            | 196       | 47-103575          | 203       | 57-0625            | 218       |                    |           |
| 47-8894802            | 196       | 47-103576          | 203       | 57-0716            | 218       |                    |           |
| 47-419310             | 196       | 47-103578          | 203       | 57-2780            | 219       |                    |           |
| 47-079992             | 196       | 47-103580          | 203       | 57-0744            | 220       |                    |           |
| 47-079998             | 196       | 47-103582          | 203       | 57-6500            | 220       |                    |           |
| 47-080369             | 197       | 47-103585          | 203       | 57-6441            | 220       |                    |           |
| 47-888810             | 197       | 47-103588          | 203       | 57-8139            | 221       |                    |           |
| 47-4700011            | 197       | 47-103589          | 203       | 57-8141            | 221       |                    |           |
| 47-006601             | 197       | 47-8845104         | 204       | 07-1173314         | 221       |                    |           |
| 47-006609             | 197       | 47-085020          | 204       | 98-567860          | 222       |                    |           |
| 47-8819101            | 198       | 47-009733          | 204       | 98-567848          | 222       |                    |           |
| 47-8819105            | 198       | 47-000290          | 204       | 98-567868          | 222       |                    |           |
| 47-483001             | 198       | 47-011111          | 204       | 98-567868          | 223       |                    |           |
| 47-108751             | 198       | 47-011122          | 204       | 98-571819          | 223       |                    |           |
| 47-108752             | 198       | 47-011112          | 204       | 98-567850          | 223       |                    |           |
| 47-108753             | 198       | 47-011113          | 204       | 98-561125          | 224       |                    |           |
| 47-108754             | 198       | 47-011115          | 204       | 98-571533          | 224       |                    |           |
| 47-108755             | 198       | 47-011116          | 204       | 98-571787          | 224       |                    |           |
| 47-108711             | 198       | 47-082355          | 205       | 98-571795          | 225       |                    |           |
| 47-108712             | 198       | 47-8861125         | 205       | 98-561403          | 225       |                    |           |
| 47-108713             | 198       | 47-082373          | 205       | 98-571805          | 225       |                    |           |
| 47-108714             | 198       | 47-009680          | 205       | 98-574530          | 226       |                    |           |
| 47-108715             | 198       | 47-009681          | 205       | 98-570207          | 226       |                    |           |
| 47-880311             | 199       | 47-8856152         | 205       | 98-561535          | 226       |                    |           |
| 47-880312             | 199       | 47-8856154         | 205       | 98-561488          | 227       |                    |           |
| 47-001142             | 199       | 47-8856156         | 205       | 98-574550          | 227       |                    |           |
| 47-001156             | 199       | 47-8856160         | 205       | 98-570212          | 227       |                    |           |
| 47-880121             | 199       | 47-8856162         | 205       | 98-561512          | 227       |                    |           |
| 47-045014             | 199       | 47-009401          | 205       | 98-564378          | 228       |                    |           |
| 47-044015             | 200       | 47-080044          | 206       | 98-564354          | 228       |                    |           |
| 47-044032             | 200       | 47-080049          | 206       | 98-564371          | 228       |                    |           |
| 47-044039             | 200       | 47-885500          | 206       | 98-564308          | 229       |                    |           |
| 47-8801205            | 200       | 47-8871226         | 206       | 98-570762          | 229       |                    |           |
| 47-8801207            | 200       | 47-003820          | 206       | 98-570734          | 229       |                    |           |
| 47-001807             | 200       | 47-003821          | 206       | 98-564271          | 230       |                    |           |
| 47-001802             | 200       | 47-003822          | 206       | 98-574284          | 230       |                    |           |
| 47-001803             | 200       | 47-003826          | 206       | 98-574355          | 230       |                    |           |
| 47-019600             | 201       | 47-003827          | 206       | 98-574359          | 231       |                    |           |
| 47-026002             | 201       | 47-8871228         | 206       | 98-574228          | 231       |                    |           |
| 47-8812201            | 201       | 57-1780            | 207       | 98-574320          | 231       |                    |           |
| 47-881222             | 201       | 57-3780            | 207       | 98-574375          | 231       |                    |           |
| 47-070072             | 201       | 57-0985            | 207       | 98-574341          | 232       |                    |           |
| 47-881223             | 201       | 57-3730            | 208       | 98-574392          | 232       |                    |           |

